

Hyper Multi TOPLED® Hyper-Bright LED

LSY T676



Besondere Merkmale

- **Gehäusotyp:** weißes P-LCC-4 Gehäuse
- **Besonderheit des Bauteils:** bei geeigneter Ansteuerung ist ein Farbwechsel von gelb über orange bis rot möglich
- **Wellenlänge:** 633 nm (super-rot), 587 nm (gelb)
- **Abstrahlwinkel:** Lambertischer Strahler (120°)
- **Technologie:** InGaAlP
- **optischer Wirkungsgrad:** 11 lm/W (gelb), 7 lm/W (super-rot)
- **Gruppierungsparameter:** Lichtstärke
- **Verarbeitungsmethode:** für alle SMT-Bestücktechniken geeignet
- **Lötmethode:** IR Reflow Löten und Wellenlöten (TTW)
- **Vorbehandlung:** nach JEDEC Level 2
- **Gurtung:** 8 mm Gurt mit 2000/Rolle, ø180 mm oder 8000/Rolle, ø330 mm

Anwendungen

- optischer Indikator
- Einkopplung in Lichtleiter
- Hinterleuchtung (LCD, Schalter, Tasten, Displays, Werbebeleuchtung, Allgemeinbeleuchtung)

Features

- **package:** white P-LCC-4 package
- **feature of the device:** with appropriate controlling it is possible to change colors from yellow via orange to red
- **wavelength:** 633 nm (super-red), 587 nm (yellow)
- **viewing angle:** Lambertian Emitter (120°)
- **technology:** InGaAlP
- **optical efficiency:** 11 lm/W (yellow), 7 lm/W (super-red)
- **grouping parameter:** luminous intensity
- **assembly methods:** suitable for all SMT assembly methods
- **soldering methods:** IR reflow soldering and TTW soldering
- **preconditioning:** acc. to JEDEC Level 2
- **taping:** 8 mm tape with 2000/reel, ø180 mm or 8000/reel, ø330 mm

Applications

- optical indicators
- coupling into light guides
- backlighting (LCD, switches, keys, displays, illuminated advertising, general lighting)

Typ Type	Emissions- farbe Color of Emission	Farbe der Lichtaustritts- fläche Color of the Light Emitting Area	Lichtstärke		Bestellnummer Ordering Code
			Luminous Intensity $I_F = 20 \text{ mA}$ $I_V \text{ (mcd)}$		
			super-red	yellow	
LSY T676	super-red / yellow	colorless clear	45 ... 180	45 ... 180	Q62703Q3428
LSY T676-P+P			45 ... 71	45 ... 71	
LSY T676-P+Q			45 ... 71	71 ... 112	
LSY T676-P+R			45 ... 71	112 ... 180	
LSY T676-Q+Q			71 ... 112	71 ... 112	
LSY T676-Q+R			71 ... 112	112 ... 180	

Helligkeitswerte werden mit einer Stromeinprägedauer von 25 ms und einer Genauigkeit von $\pm 11 \%$ ermittelt.
Luminous intensity is tested at a current pulse duration of 25 ms and a tolerance of $\pm 11 \%$.

Anm.: Die Standardlieferform von Serientypen beinhaltet eine Familiengruppe. Einzelne Gruppen sind nicht erhältlich.

In einer Verpackungseinheit / Gurt ist immer nur eine Gruppe pro Farbe enthalten.

Note: The standard shipping format for serial types includes a family group. Individual groups are not available.

No packing unit / tape ever contains more than one luminous intensity group per color.

Grenzwerte
Maximum Ratings

Bezeichnung Parameter	Symbol Symbol	Werte Values		Einheit Unit
		LS	LY	
Betriebstemperatur Operating temperature range	T_{op}	- 40 ... + 100		°C
Lagertemperatur Storage temperature range	T_{stg}	- 40 ... + 100		°C
Sperrschichttemperatur Junction temperature	T_j	+ 125		°C
Durchlassstrom Forward current	I_F	30		mA
Stoßstrom Surge current $t \leq 10 \mu s, D = 0.005$	I_{FM}	1	0.2	A
Sperrspannung ¹⁾ Reverse voltage	V_R	12		V
Leistungsaufnahme Power consumption	P_{tot}	80		mW
Wärmewiderstand Thermal resistance				
Sperrschicht/Umgebung Junction/air	1 chip on $R_{th JA}$ 2 chips on $R_{th JA}$	580		K/W K/W
Sperrschicht/Löt-pad Junction/solder point	1 chip on $R_{th JS}$ 2 chips on $R_{th JS}$	340		K/W K/W
Montage auf PC-Board FR 4 (Padgröße $\geq 16 \text{ mm}^2$) mounted on PC board FR 4 (pad size $\geq 16 \text{ mm}^2$)		470		K/W

¹⁾ für kurzzeitigen Betrieb geeignet / suitable for short term application

Kennwerte ($T_A = 25\text{ °C}$)

Characteristics

Bezeichnung Parameter	Symbol Symbol	Werte Values		Einheit Unit
		LS	LY	
Wellenlänge des emittierten Lichtes (typ.) Wavelength at peak emission $I_F = 20\text{ mA}$	λ_{peak}	645	591	nm
Dominantwellenlänge ¹⁾ (typ.) Dominant wavelength ¹⁾ $I_F = 20\text{ mA}$	λ_{dom}	633 ± 6	587 -7/+8	nm
Spektrale Bandbreite bei 50 % $I_{\text{rel max}}$ (typ.) Spectral bandwidth at 50 % $I_{\text{rel max}}$ $I_F = 20\text{ mA}$	$\Delta\lambda$	16	15	nm
Abstrahlwinkel bei 50 % I_V (Vollwinkel) (typ.) Viewing angle at 50 % I_V	2ϕ	120	120	Grad deg.
Durchlassspannung ²⁾ (typ.) Forward voltage ²⁾ (max.) $I_F = 20\text{ mA}$	V_F ²⁾ V_F	2.0 2.4	2.0 2.4	V V
Sperrstrom (typ.) Reverse current (max.) $V_R = 12\text{ V}$	I_R I_R	0.01 10	0.01 10	μA μA
Temperaturkoeffizient von λ_{peak} (typ.) Temperature coefficient of λ_{peak} $I_F = 20\text{ mA}; -10\text{ °C} \leq T \leq 100\text{ °C}$	$TC_{\lambda_{\text{peak}}}$	0.14	0.13	nm/K
Temperaturkoeffizient von λ_{dom} (typ.) Temperature coefficient of λ_{dom} $I_F = 20\text{ mA}; -10\text{ °C} \leq T \leq 100\text{ °C}$	$TC_{\lambda_{\text{dom}}}$	0.05	0.10	nm/K
Temperaturkoeffizient von V_F (typ.) Temperature coefficient of V_F $I_F = 20\text{ mA}; -10\text{ °C} \leq T \leq 100\text{ °C}$	TC_V	- 2.0	- 2.5	mV/K
Optischer Wirkungsgrad (typ.) Optical efficiency $I_F = 20\text{ mA}$	η_{opt}	7	11	lm/W

¹⁾ Wellenlängen werden mit einer Stromeinprägungsdauer von 25 ms und einer Genauigkeit von $\pm 1\text{ nm}$ ermittelt.
Wavelengths are tested at a current pulse duration of 25 ms and a tolerance of $\pm 1\text{ nm}$.

²⁾ Durchlassspannungen werden mit einer Stromeinprägungsdauer von 1 ms und einer Genauigkeit von $\pm 0,1\text{ V}$ ermittelt.
Forward voltages are tested at a current pulse duration of 1 ms and a tolerance of $\pm 0.1\text{ V}$.

Relative spektrale Emission $I_{rel} = f(\lambda)$, $T_A = 25\text{ °C}$, $I_F = 20\text{ mA}$

Relative Spectral Emission

$V(\lambda)$ = spektrale Augenempfindlichkeit
Standard eye response curve

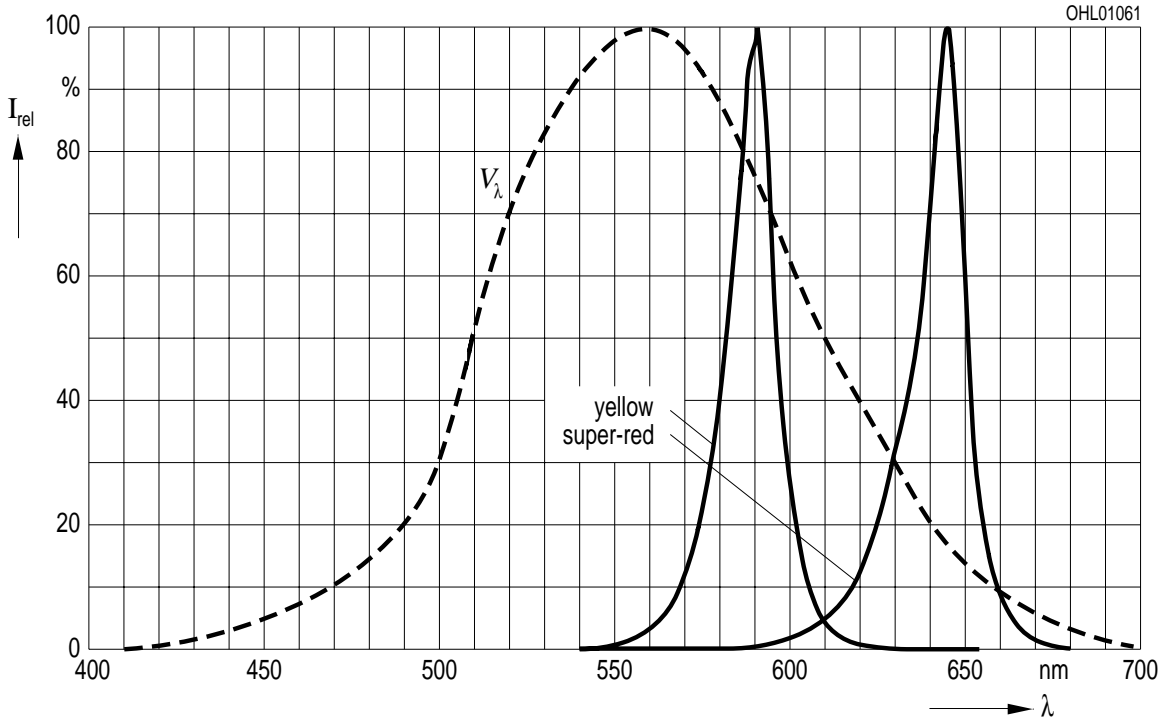

Abstrahlcharakteristik $I_{rel} = f(\varphi)$

Radiation Characteristic

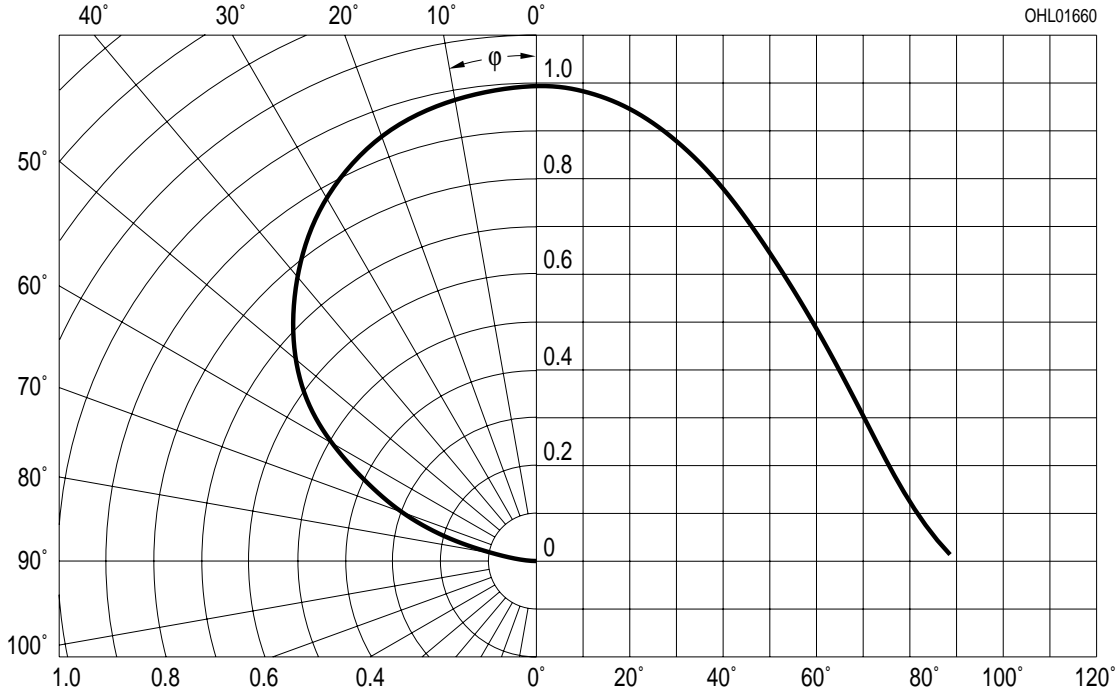

Durchlassstrom $I_F = f(V_F)$

Forward Current

$T_A = 25\text{ °C}$

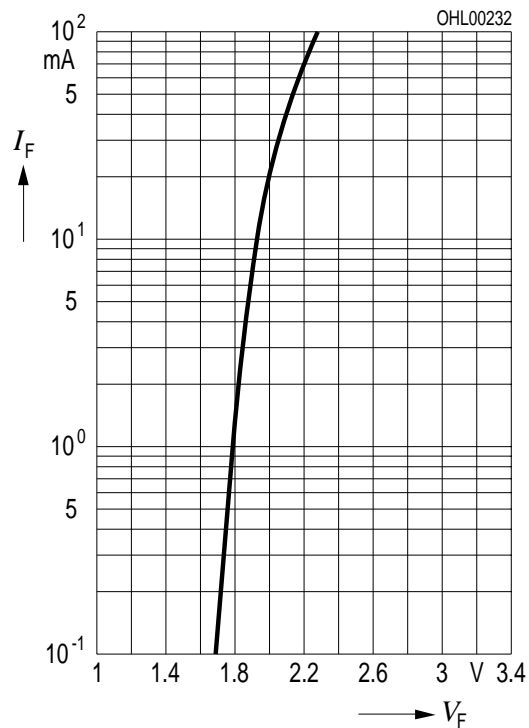

Relative Lichtstärke $I_V/I_{V(20\text{ mA})} = f(I_F)$

Relative Luminous Intensity

$T_A = 25\text{ °C}$

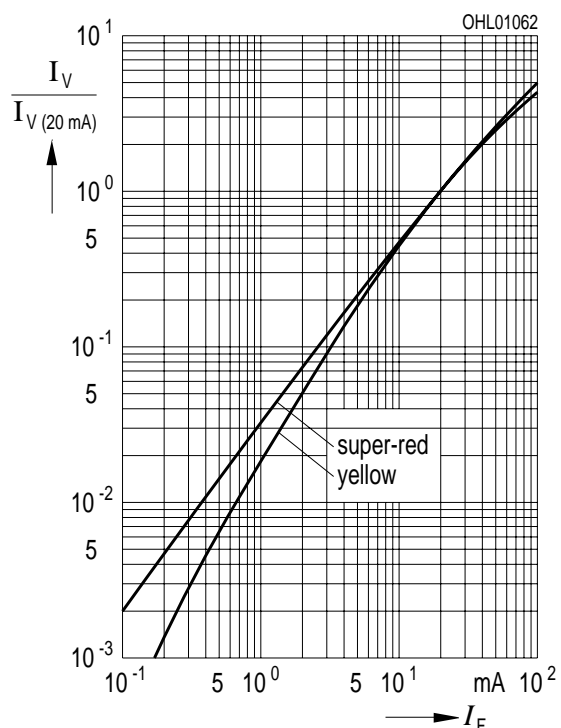

Maximal zulässiger Durchlassstrom $I_F = f(T)$

Max. Permissible Forward Current

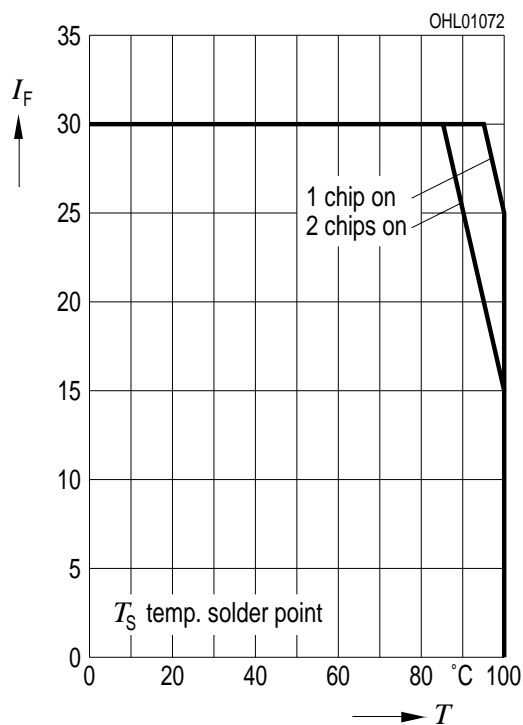

Maximal zulässiger Durchlassstrom $I_F = f(T)$

Max. Permissible Forward Current

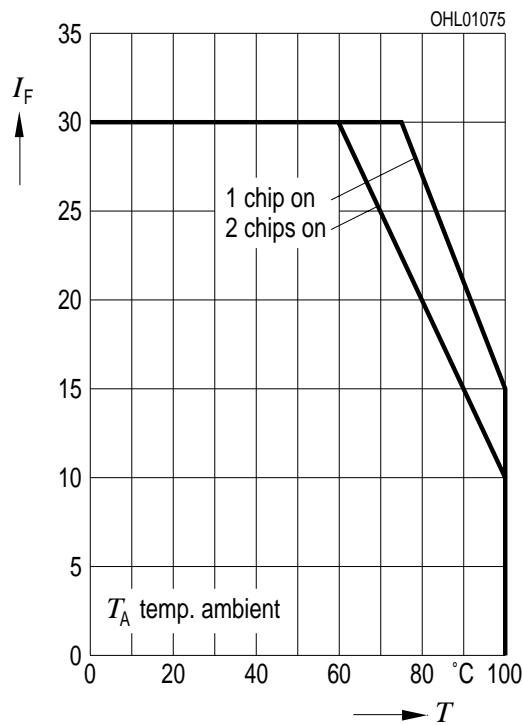

Relative Lichtstärke $I_V/I_{V(25^\circ\text{C})} = f(T_A)$
Relative Luminous Intensity

$I_F = 20 \text{ mA}$

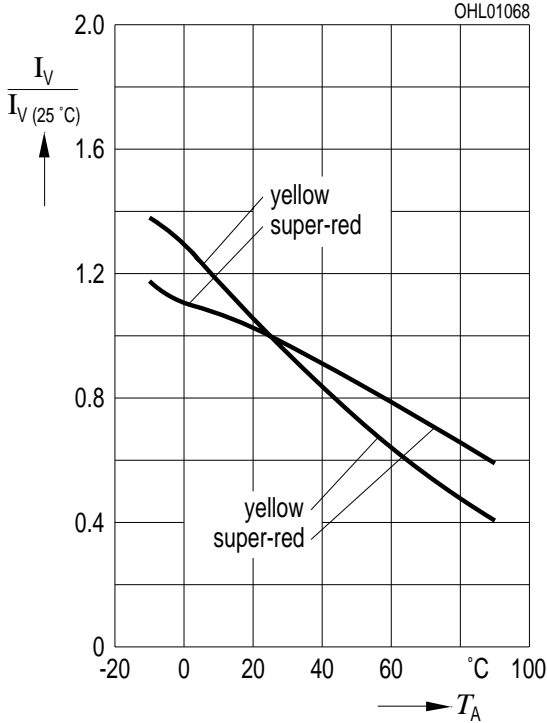

Zulässige Impulsbelastbarkeit $I_F = f(t_p)$
Permissible Pulse Handling Capability
 Duty cycle $D = \text{parameter}$, $T_A = 25^\circ\text{C}$
LS

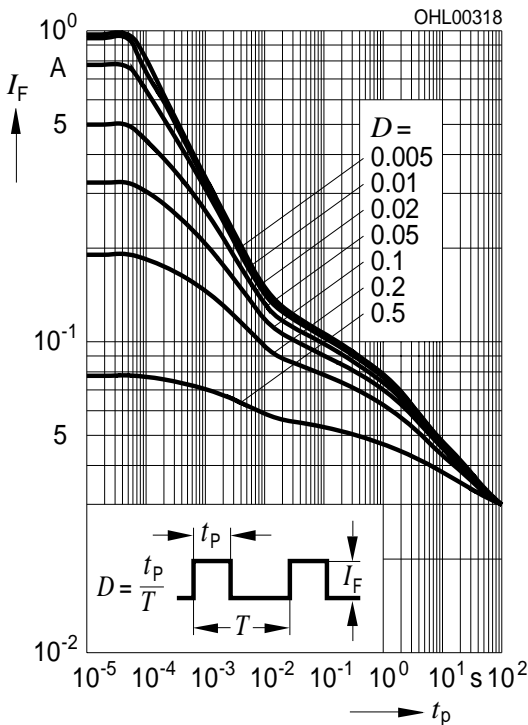

Zulässige Impulsbelastbarkeit $I_F = f(t_p)$
Permissible Pulse Handling Capability
 Duty cycle $D = \text{parameter}$, $T_A = 25^\circ\text{C}$
LY

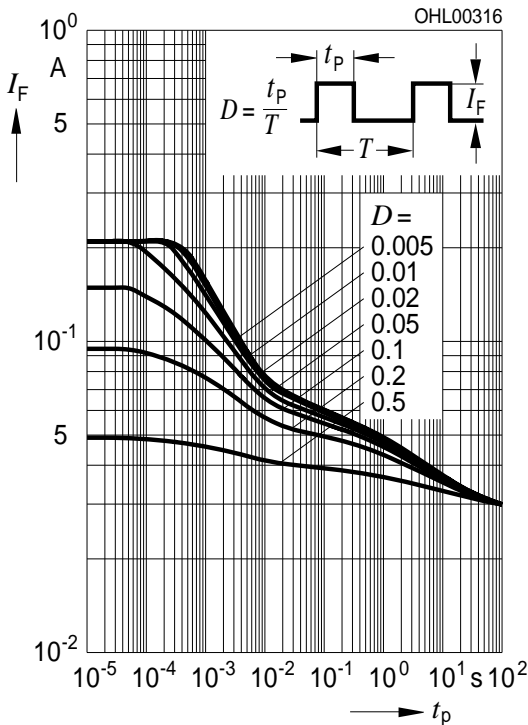

Maßzeichnung
Package Outlines

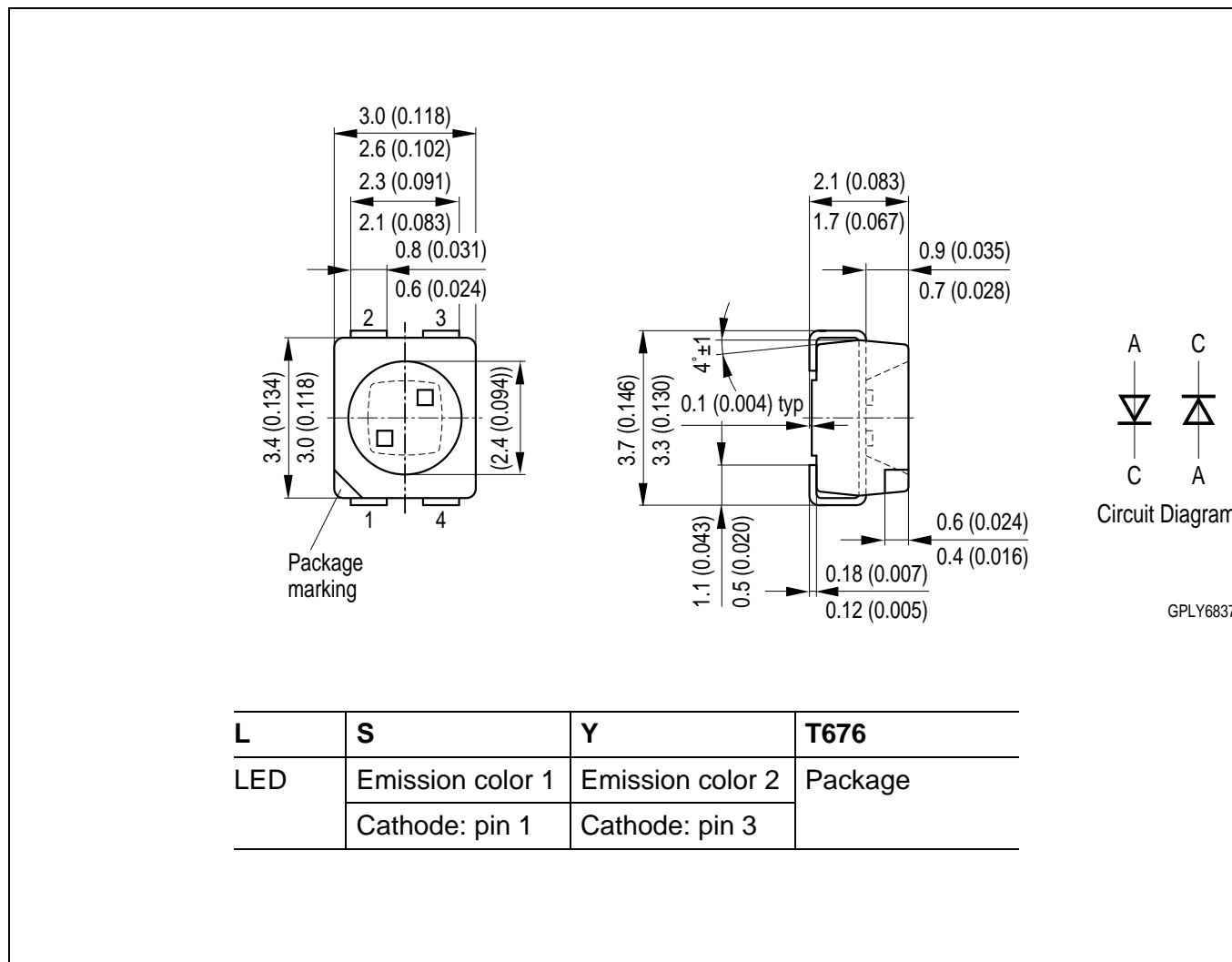

Maße werden wie folgt angegeben: mm (inch) / Dimensions are specified as follows: mm (inch).

Gewicht / Approx. weight: 35 mg

Lötbedingungen Vorbehandlung nach JEDEC Level 2
Soldering Conditions Preconditioning acc. to JEDEC Level 2

IR-Reflow Lötprofil (nach IPC 9501)
IR Reflow Soldering Profile (acc. to IPC 9501)

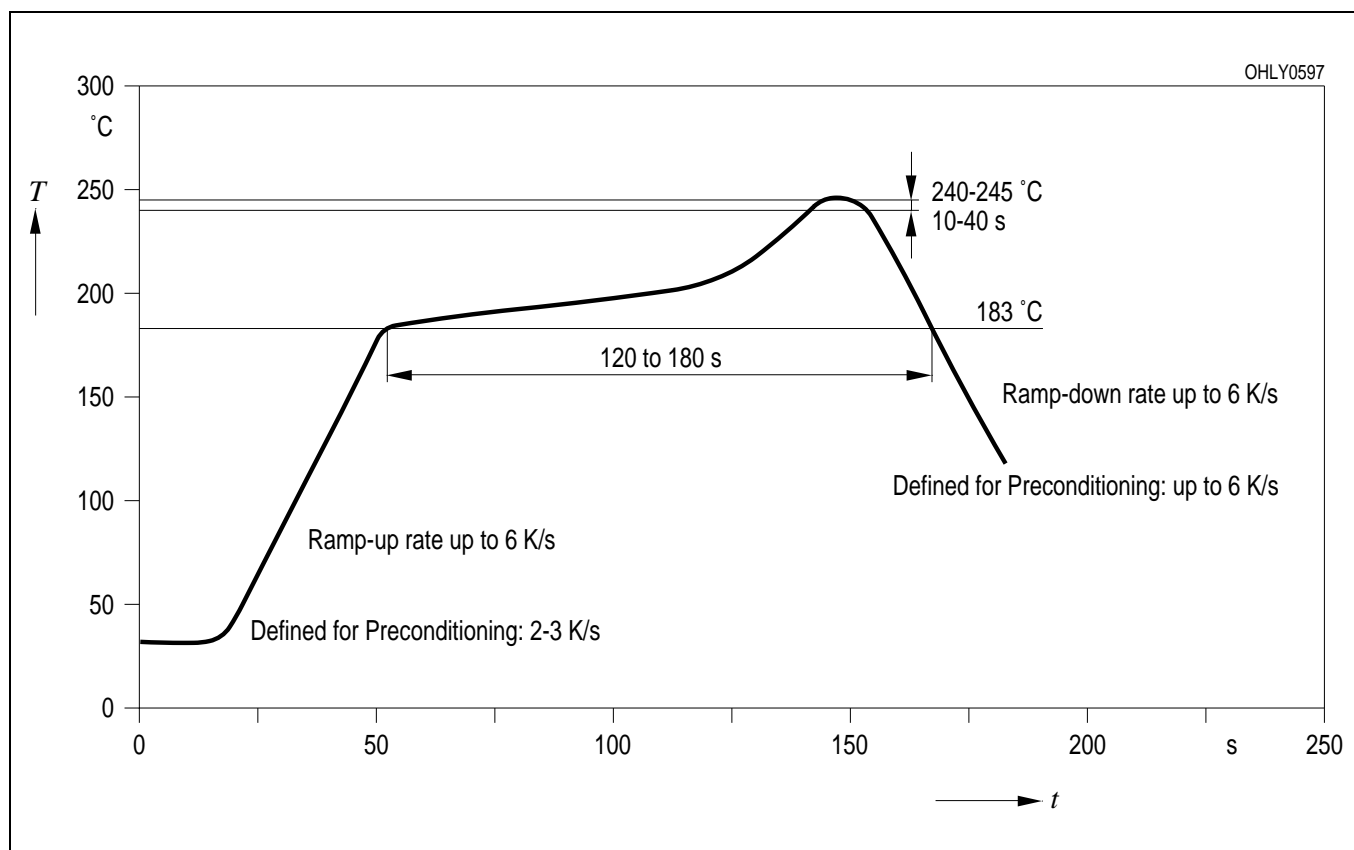

Wellenlöten (TTW) (nach CECC 00802)
TTW Soldering (acc. to CECC 00802)

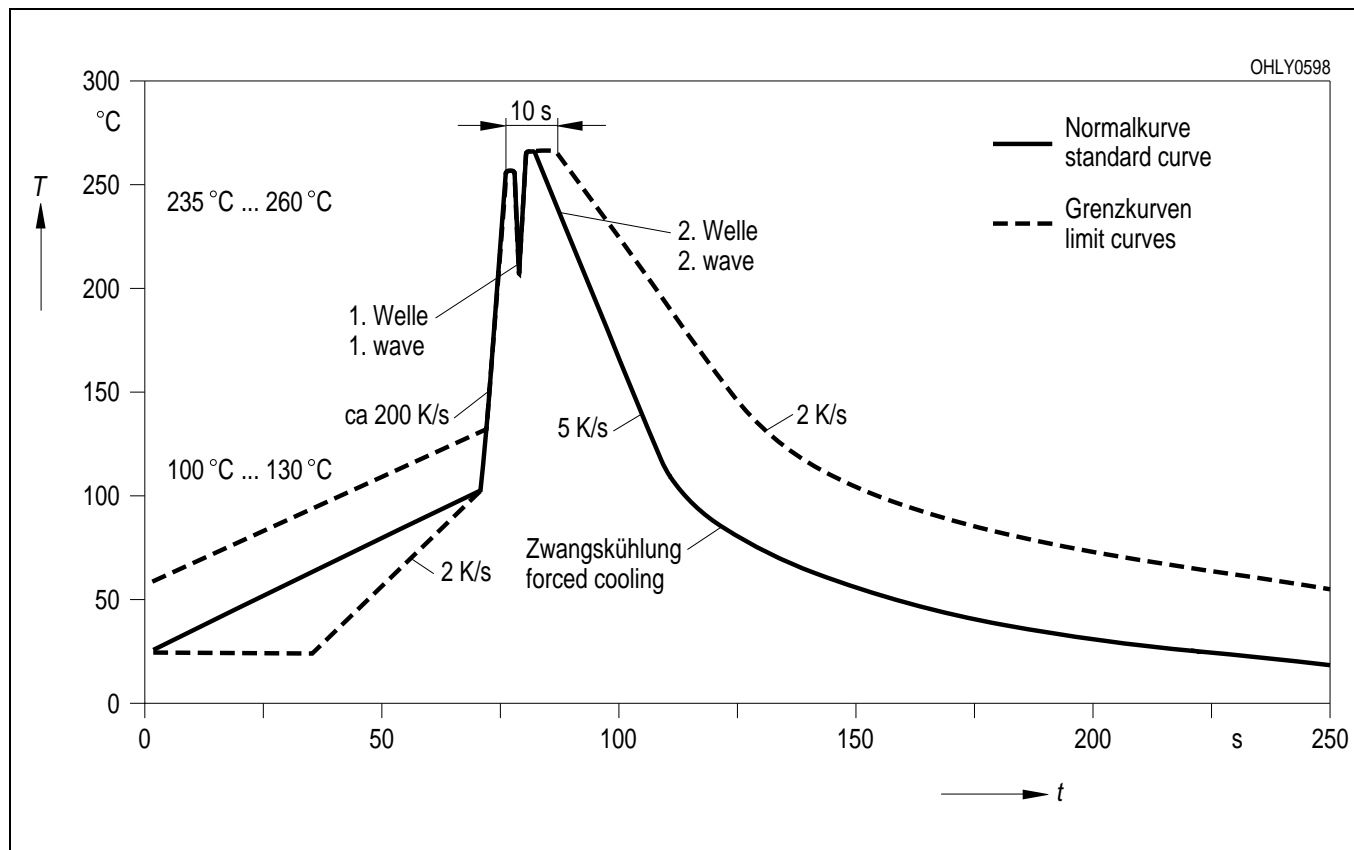

Empfohlenes Lötpad design IR Reflow Löten
Recommended Solder Pad IR Reflow Soldering

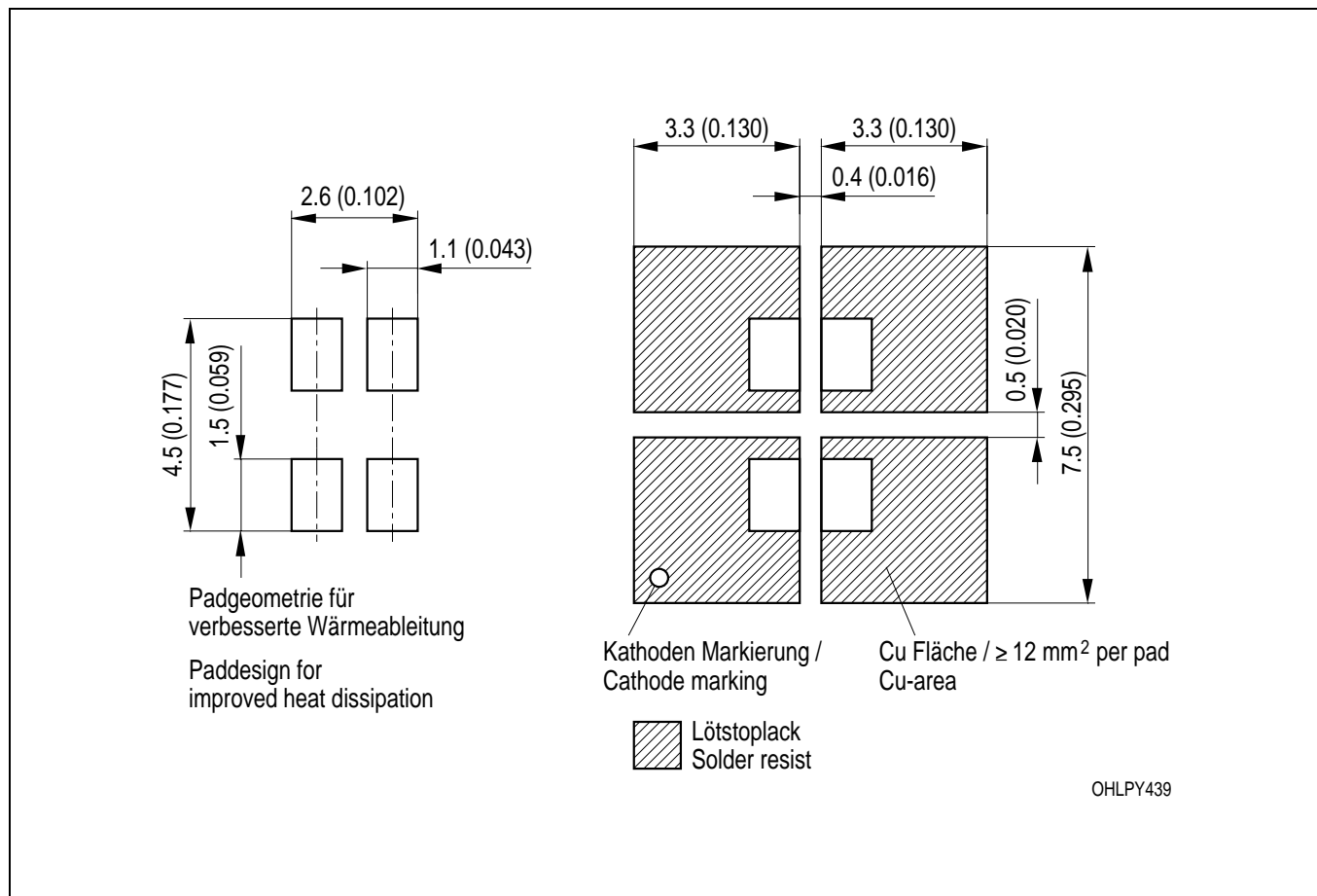

Maße werden wie folgt angegeben: mm (inch) / Dimensions are specified as follows: mm (inch).

Empfohlenes Lötpad Design Wellenlöten (TTW)
Recommended Solder Pad TTW Soldering

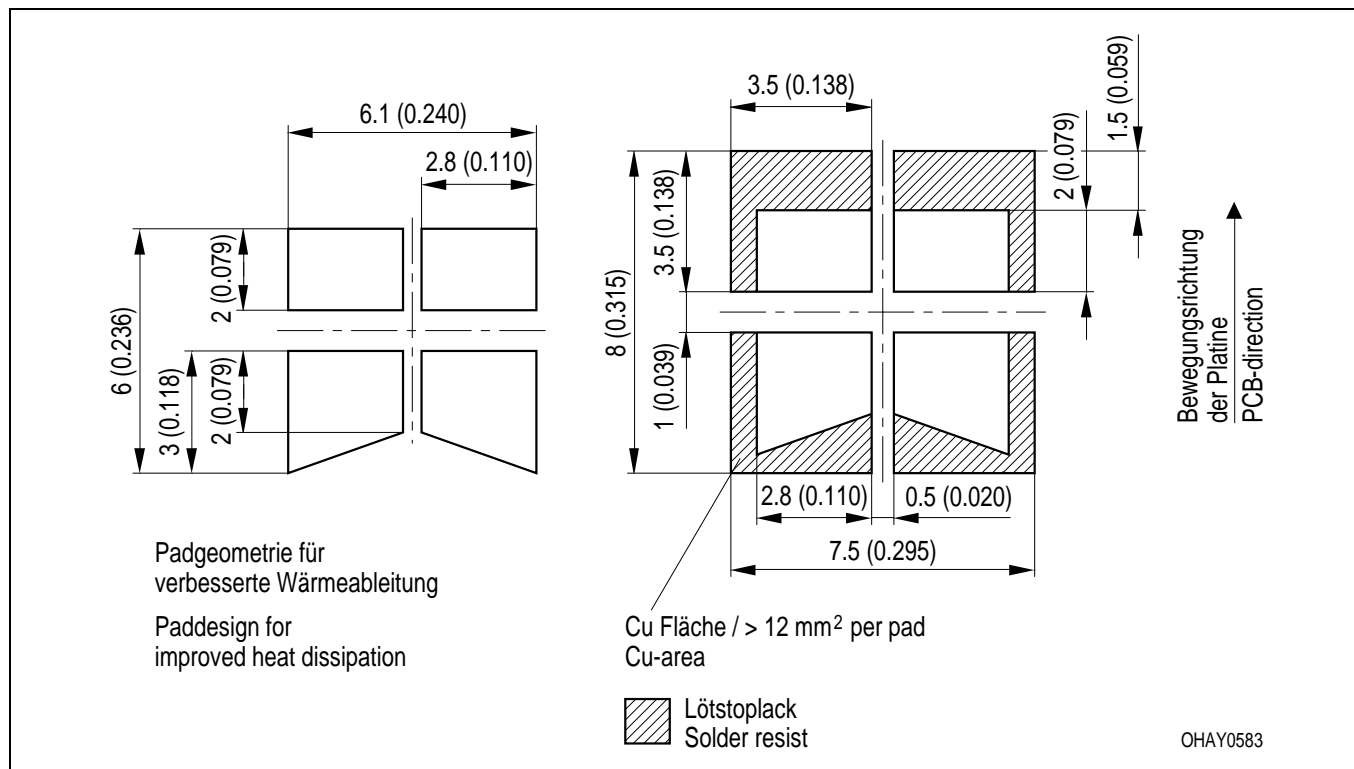

Maße werden wie folgt angegeben: mm (inch) / Dimensions are specified as follows: mm (inch).

Gurtung / Polarität und Lage

Verpackungseinheit 2000/Rolle, ø180 mm
 oder 8000/Rolle, ø330 mm

Method of Taping / Polarity and Orientation

Packing unit 2000/reel, ø180 mm
 or 8000/reel, ø330 mm

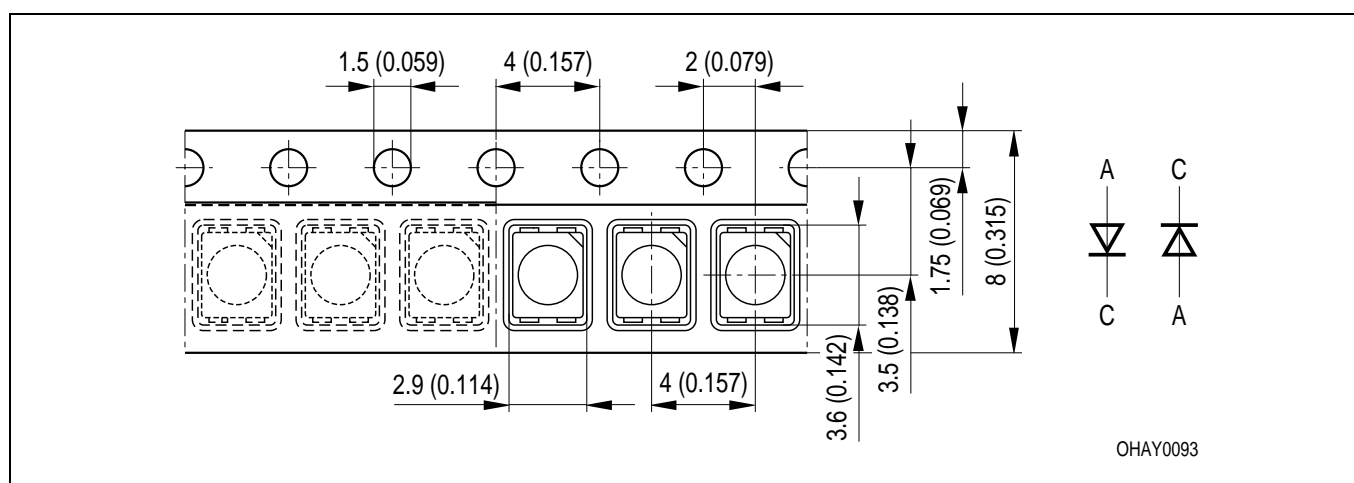

Maße werden wie folgt angegeben: mm (inch) / Dimensions are specified as follows: mm (inch).

Revision History: 2003-03-04		Date of change
Previous Version: 2002-09-18		
Page	Subjects (major changes since last revision)	
13	annotations	2002-07-25
4	value ($TC_{\lambda_{dom}}$ from 0.01 to 0.05 nm/K)	2002-07-25
3, 4	value (reverse voltage from 3 V to 12 V)	2002-09-18

Published by OSRAM Opto Semiconductors GmbH
Wernerwerkstrasse 2, D-93049 Regensburg
© All Rights Reserved.

Attention please!

The information describes the type of component and shall not be considered as assured characteristics.

All typical data and graphs are basing on representative samples, but don't represent the production range. If requested, e.g. because of technical improvements, these typ. data will be changed without any further notice.

Terms of delivery and rights to change design reserved. Due to technical requirements components may contain dangerous substances. For information on the types in question please contact our Sales Organization.

If printed or downloaded, please find the latest version in the Internet.

Packing

Please use the recycling operators known to you. We can also help you – get in touch with your nearest sales office. By agreement we will take packing material back, if it is sorted. You must bear the costs of transport. For packing material that is returned to us unsorted or which we are not obliged to accept, we shall have to invoice you for any costs incurred.

Components used in life-support devices or systems must be expressly authorized for such purpose! Critical components ¹ may only be used in life-support devices or systems ² with the express written approval of OSRAM OS.

¹ A critical component is a component used in a life-support device or system whose failure can reasonably be expected to cause the failure of that life-support device or system, or to affect its safety or the effectiveness of that device or system.

² Life support devices or systems are intended (a) to be implanted in the human body, or (b) to support and/or maintain and sustain human life. If they fail, it is reasonable to assume that the health of the user may be endangered.