

# Motor Timer H2C

CSM\_H2C\_DS\_E\_2\_2

## DIN-sized 48 x 48 Motor Timer with Simple Operation for Switching Time Specifications

- Three Motor Timers cover the wide time range of 6 s to 30 h with easy operation from the operation panel.
- Five time specifications for each model with linked time display.
- DIN-standard size of 48 x 48 mm.
- Easily check operation with neon lamp.
- Models with sockets and models with top wiring are also available.
- Certified for UL and CSA safety standards.
- Conforms to EN 61812-1 (except models that end with “-F”) and CE Marking.



## Model Number Structure

### Model Number Legend

H2C-□ □-□  
1 2 3

#### 1. External Connection/Attachment

- None: 11-pin socket
- 8: 8-pin socket
- F: Front screw

#### 2. Operation/Resetting System

- None: Time-limit operation/self-resetting
- R: Time-limit operation/electric resetting

#### 3. Attachment

- S: Time setting ring

## Ordering Information

### List of Models

| Operation/resetting system                  | Internal connection                        | Terminal                                   | Time-limit contact | Instantaneous contact | Attachment                   | Model                        |         |
|---|--|--|--------------------|-----------------------|------------------------------|------------------------------|---------|
| Time-limit operation/<br>self-resetting     | Parallel motor and<br>clutch connection    | 8-pin socket                               | SPDT               | SPDT                  | ---                          | H2C-8                        |         |
|   |  | 11-pin socket                              |                    |                       |                              | H2C                          |         |
|   | Separate motor<br>and clutch<br>connection | Front screw                                |                    |                       | Y92A-Y1 Time<br>Setting Ring | H2C-S                        |         |
|   |  | ---  |                    |                       | H2C-F                        |                              |         |
| Time-limit operation/<br>electric resetting | Parallel motor and<br>clutch connection    | 8-pin socket                               | SPDT               | ---                   | ---                          | H2C-8R                       |         |
|   |  | 11-pin socket                              |                    |                       |                              | H2C-R                        |         |
|   |  | Separate motor<br>and clutch<br>connection |                    |                       |                              | Y92A-Y1 Time<br>Setting Ring | H2C-R-S |
|   |  |  |                    |                       |                              | ---                          | H2C-FR  |

**Note:** Specify both the supply voltage and time range code (A, B, or C) in addition to the model number when ordering.

Example: H2C-S 24 VAC B  
 └───┬─── Time range code  
 └───┴─── Supply voltage

## ■ Accessories (Order Separately)

| Name/specifications                    |                           | Models                              |
|--|---------------------------|-------------------------------------|
| Flush Mounting Adapter                 |                           | Y92F-30                             |
| Time Setting Ring (See note 1.)        |                           | Y92A-Y1                             |
| Mounting Track                         | 50 cm (l) × 7.3 mm (t)    | PFP-50N                             |
|  | 1 m (l) × 7.3 mm (t)      | PFP-100N                            |
|  | 1 m (l) × 16 mm (t)       | PFP-100N2                           |
| End Plate                              |                           | PFP-M                               |
| Spacer                                 |                           | PFP-S                               |
| Protective Cover                       |                           | Y92A-48B                            |
| Track Mounting/Front Connecting Socket | 8-pin                     | P2CF-08                             |
|  | 8-pin, finger safe type   | P2CF-08-E                           |
|  | 11-pin                    | P2CF-11                             |
|  | 11-pin, finger safe type  | P2CF-11-E                           |
| Back Connecting Socket                 | 8-pin, screw terminal     | P3G-08                              |
|  | 8-pin, finger safe type   | P3G-08 with Y92A-48G (See note 2.)  |
|  | 11-pin                    | P3GA-11                             |
|  | 11-pin, finger safe type  | P3GA-11 with Y92A-48G (See note 2.) |
| Hold-down Clip (See note 3.)           | For PL08 and PL11 Sockets | Y92H-1                              |
|  | For PF085A Socket         | Y92H-2                              |

**Note:** 1. Supplied with H2C-S/-R-S models.

2. Y92A-48G is a finger safe terminal cover which is attached to the P3G-08 or P3GA-11 Socket.





3. Hold-down Clips are sold in sets of two.

## Specifications

### ■ Time Ranges

Five time ranges are available for each timer by turning the time range selector every 60 degrees.

**Note:** Rated time is displayed on the window.

| Time range code | Position of time range selector   |   |   |   |   |
|-----------------|---|---|---|---|---|
|                 |  |  |  |  |  |
| <b>A</b>        | 1.25 to 30 s  | 7.5 s to 3 min  | 1.25 to 30 min  | 7.5 min to 3 h  | 1.25 to 30 h  |
| <b>B</b>        | 0.2 to 6 s  | 2 to 60 s   | 0.2 to 6 min  | 2 to 60 min   | 0.2 to 6 h  |
| <b>C</b>        | 0.5 to 12 s   | 5 to 120 s  | 0.5 to 12 min   | 5 to 120 min  | 0.5 to 12 h   |

### ■ Ratings

| Item   | H2C  |
|--|--|
| <b>Rated supply voltage (motor and clutch)</b> | 24, 48, 100, 110, 115, 120, 200, 220, or 240 VAC (50/60 Hz) (see note)             |
| <b>Operating voltage range</b>                 | 85% to 110% of rated supply voltage  |
| <b>Power consumption</b>                       | 4.2 VA max. (3.96 W max.)  |
| <b>Reset voltage</b>                           | 10% max. of rated supply voltage   |
| <b>Reset time</b>                              | Minimum power-opening time: 0.5 s<br>Minimum pulse width: 0.5 s                    |
| <b>Control outputs</b>                         | 6 A at 250 VAC, resistive load (cosφ = 1)  |
| <b>Mounting method</b>                         | Flush mounting (except for H2C-F/-FR models), surface mounting, DIN track mounting |

**Note:** The front panel of the timer is color coded to identify the following supply voltage classifications:

100 to 120 V: Blue

200 to 240 V: Red

Other classes: Black

## ■ Characteristics

|                                       |  |
|---------------------------------------|--|
| <b>Accuracy of operating time</b>     | ±0.5% FS max. (±1% max. at 0.2 to 6 s for the time range code B or at 0.5 to 12 s for the time range code C)   |
| <b>Setting error</b>                  | ±2% FS max.  |
| <b>Reset time</b>                     | 0.5 s max.   |
| <b>Influence of voltage</b>           | ±1% FS max.  |
| <b>Influence of temperature</b>       | ±2% FS max.  |
| <b>Insulation resistance</b>          | 100 MΩ min. (at 500 VDC)   |
| <b>Dielectric strength</b>            | 2,500 VAC, 50/60 Hz for 1 min (between current-carrying and non-current-carrying parts)<br>2,000 VAC, 50/60 Hz for 1 min (between contact and control circuit and between contacts of different polarities)<br>1,000 VAC, 50/60 Hz for 1 min (between non-continuous contacts)   |
| <b>Vibration resistance</b>           | Destruction: 10 to 55 Hz with 0.375-mm single amplitude for 1 h each in three directions<br>Malfunction: 10 to 55 Hz with 0.25-mm single amplitude for 10 min each in three directions   |
| <b>Shock resistance</b>               | Destruction: 1,000 m/s <sup>2</sup><br>Malfunction: 150 m/s <sup>2</sup>   |
| <b>Ambient temperature</b>            | Operating: -10°C to 50°C<br>Storage: -25°C to 65°C   |
| <b>Ambient humidity</b>               | Operating: 45% to 85%  |
| <b>Life expectancy</b>                | Mechanical: 10,000,000 operations min. (under no load at 1,800 operations/h)<br>Electrical: 200,000 operations min. (3 A at 250 VAC, resistive load at 1,800 operations/h)<br>See <i>Life-test Curve</i> for other details.  |
| <b>Motor life expectancy</b>          | 20,000 h   |
| <b>Approved standards</b>             | UL917, CSA C22.2 No.14.<br>Conforms to EN61812-1 and IEC60664-1 4 kV/1 (except for H2C-F□ models).<br>Output category according to EN60947-5-1 (except for H2C-F□ models).   |
| <b>EMC (except for H2C-F□ models)</b> | (EMI) EN61812-1<br>Emission Enclosure: EN55011 Group 1 class A<br>Emission AC Mains: EN55011 Group 1 class A<br>(EMS) EN61812-1<br>Immunity ESD: IEC61000-4-2: 6 kV contact discharge (level 3)<br>8 kV air discharge (level 3)<br>Immunity RF-interference from AM Radio Waves: IEC61000-4-3: 10 V/m (80 MHz to 1 GHz) (level 3)<br>Immunity Burst: IEC61000-4-4: 2 kV power-line (level 3)<br>2 kV I/O signal-line (level 4)<br>Immunity Surge: IEC61000-4-5: 1 kV line to line (level 3)<br>2 kV line to ground (level 3) |
| <b>Case color</b>                     | Light gray (Munsell 5Y7/1)   |
| <b>Degree of protection</b>           | IP40 (panel surface)   |
| <b>Weight</b>                         | H2C series: approx. 180 g<br>H2C-F series: approx. 270 g   |

# Connections

## Terminal Arrangement

**Note:** The connections diagrams are for when the clutch is in the excited, reset state.

H2C-8

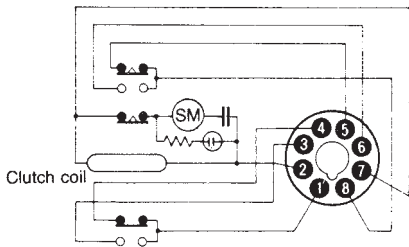

H2C-8R

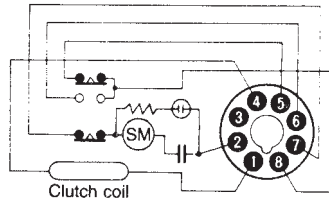

H2C(-F)/H2C-S

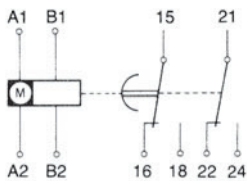
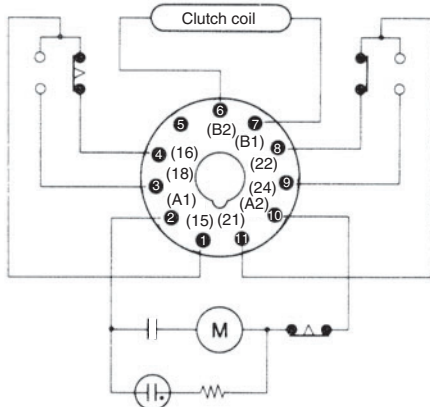

(DIN 46 199-5)

H2C(-F)R/H2C-R-S

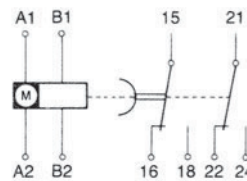
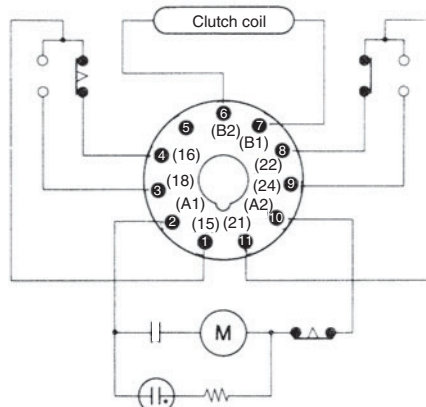

(DIN 46 199-5)

# Operation

## ■ Timing Chart

### H2C-8

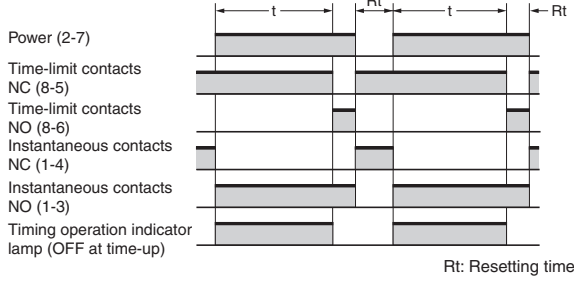

### H2C-8R

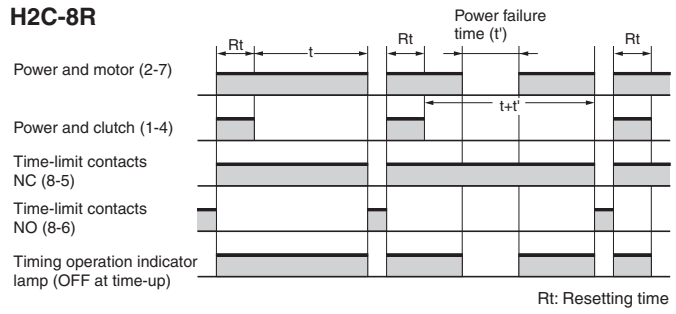

### H2C(-F)/H2C-S

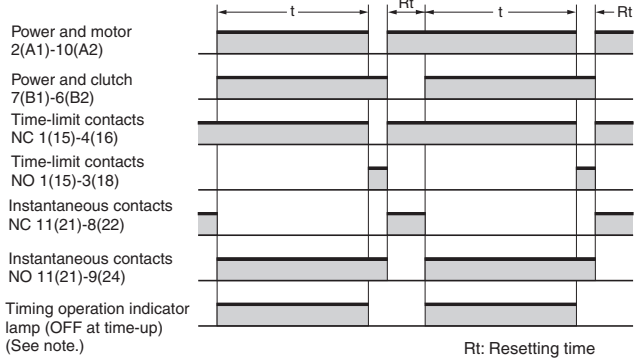

### H2C(-F)R/H2C-R-S

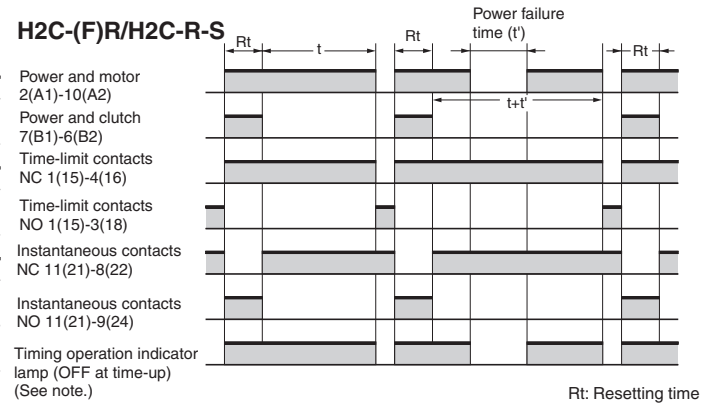

**Note:** For the types rated at 24 and 48 VAC, the timing operation indicator is not equipped.

## Nomenclature

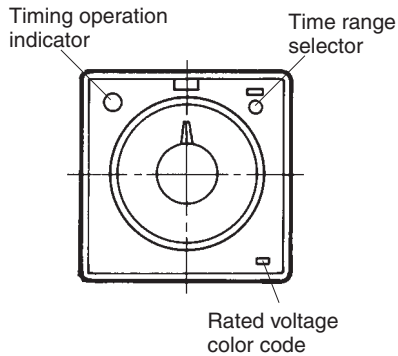

# Dimensions

Note: All units are in millimeters unless otherwise indicated.

## H2C/H2C-S/H2C-R/H2C-R-S/H2C-8/H2C-8R

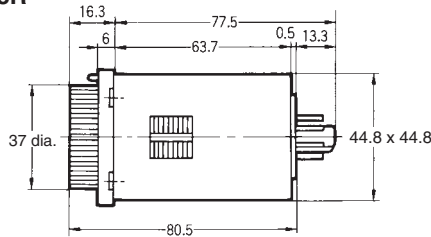
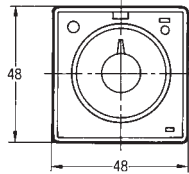
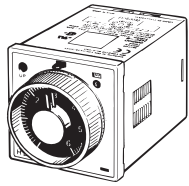

### For Flush Mounting

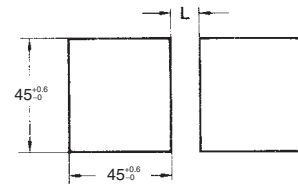

For a load current of 3 A max., dimension L becomes 3 mm min. with an interval of 0 mm between timers.  
 For a load current of 6 A max., dimension L becomes 8 mm min. with an interval of 5 mm between timers.  
 When using in locations with high ambient temperatures, ensure that there is an interval of at least 5 mm between timers.

## H2C-F/H2C-FR

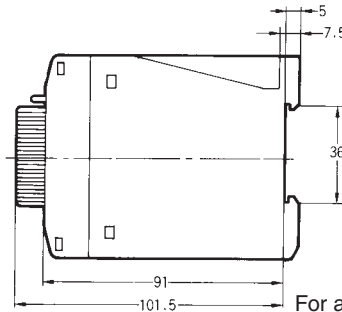
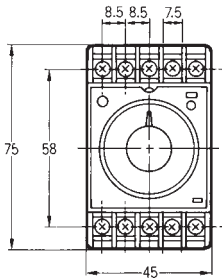
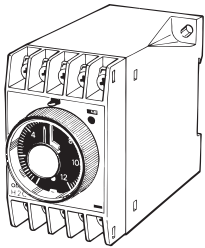

### Mounting Holes

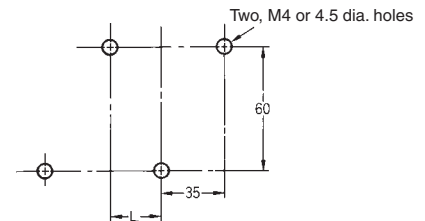

For a load current of 1 A max., dimension L becomes 10 mm min. with an interval of 0 mm between timers.  
 For a load current of 3 A max., dimension L becomes 15 mm min. with an interval of 5 mm between timers.  
 For a load current of 6 A max., dimension L becomes 20 mm min. with an interval of 10 mm between timers.

## Dimensions with Front Connecting Socket P2CF-08-□/P2CF-11-□

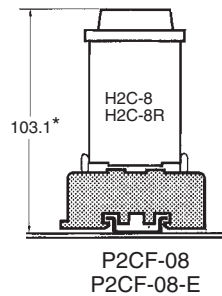
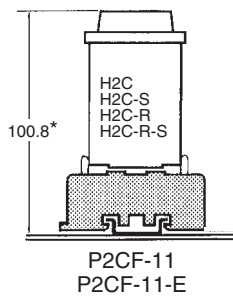

## Dimensions with Back Connecting Socket P3G-08/P3GA-11

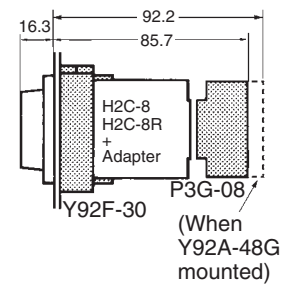
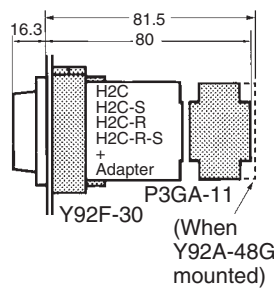

\*These dimensions vary with the kind of DIN track (reference value).

■ Accessories (Order Separately)

**Adapter for Flush Mounting**

Y92F-30

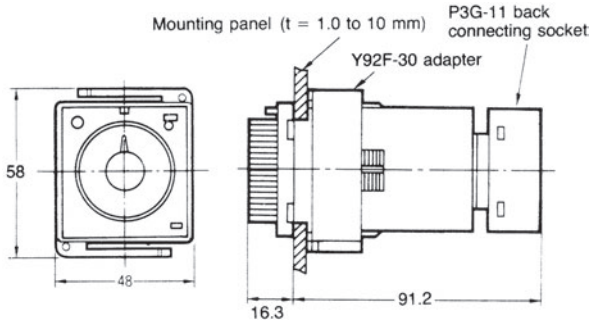

**Track Mounting/Front Connecting Socket**

P2CF-08

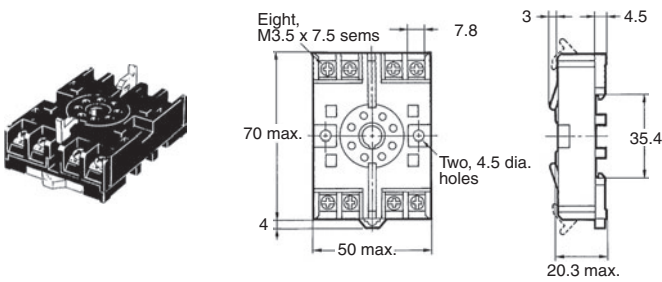

Terminal Arrangement/  
Internal Connections  
(Top View)

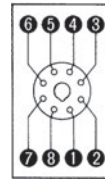

Surface Mounting Holes

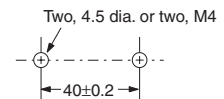

**P2CF-08-E (Finger Safe Terminal Type)  
Conforming to VDE0106/P100**

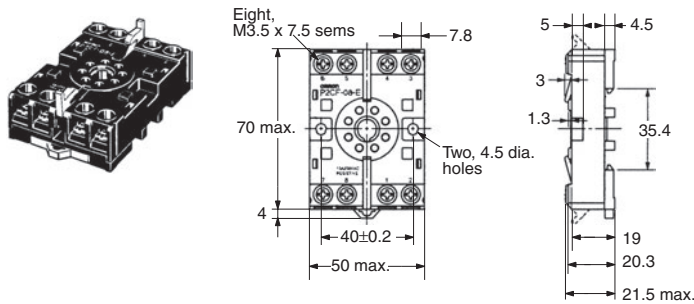

## Track Mounting/Front Connecting Socket

### P2CF-11

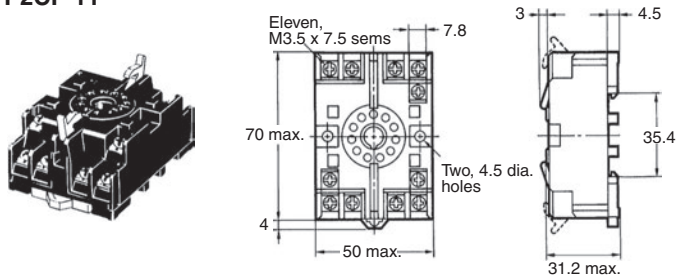

Terminal Arrangement/  
Internal Connections  
(Top View)

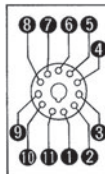

Surface Mounting Holes

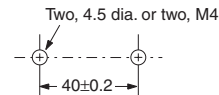

### P2CF-11-E (Finger Safe Terminal Type) Conforming to VDE0106/P100

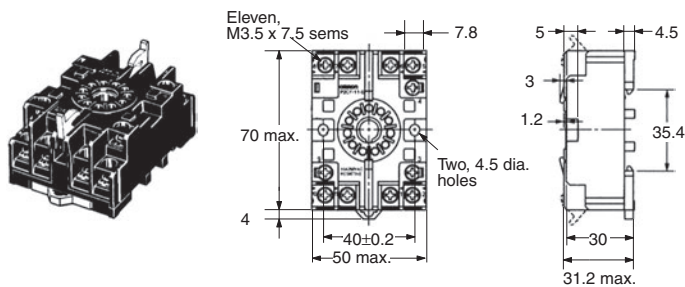

## Back Connecting Socket

### P3G-08

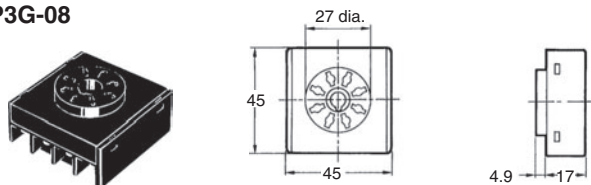

Terminal Arrangement/  
Internal Connections  
(Bottom View)

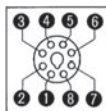

### P3GA-11

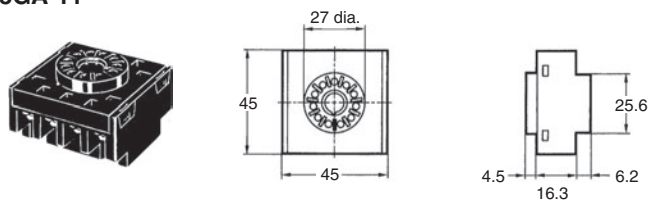

Terminal Arrangement/  
Internal Connections  
(Bottom View)

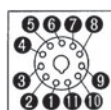

## Finger Safe Terminal Cover

Conforming to VDE0106/P100

### Y92A-48G

(Attachment for P3G-08/  
P3GA-11 Socket)

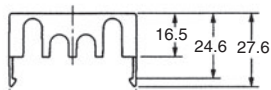
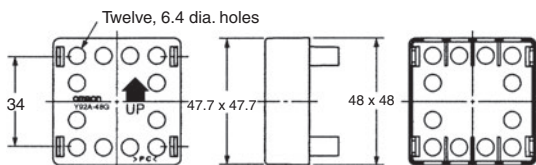
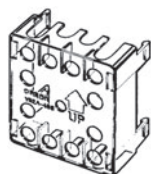

## Mounting Track

PFP-100N, PFP-50N

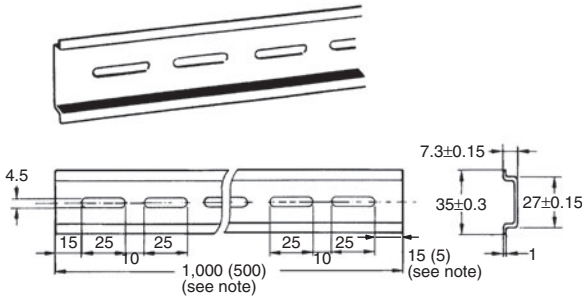

PFP-100N2

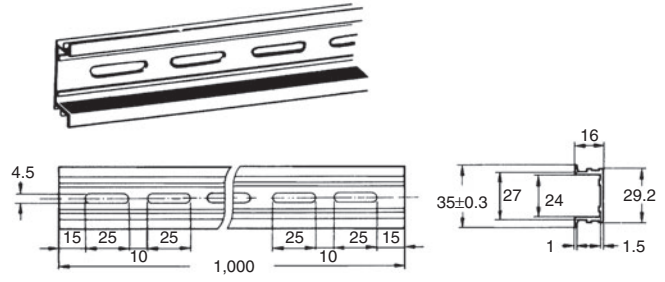

**Note:** The value shown in parentheses are for the PFP-50N.

## End Plate

PFP-M

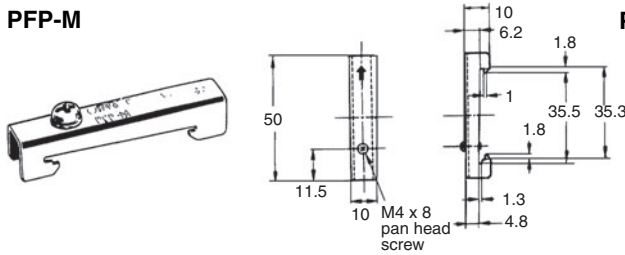

## Spacer

PFP-S

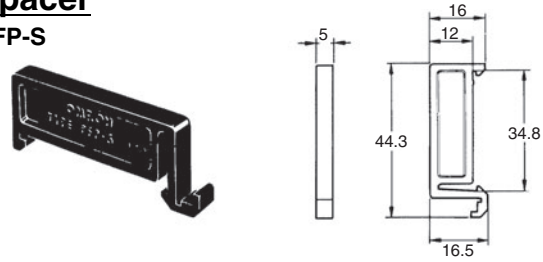

## Time Setting Ring

Y92A-Y1

The time setting ring locks the time setting knob to store the set time to facilitate its resetting. A maximum of two time setting rings are connectable per timer.

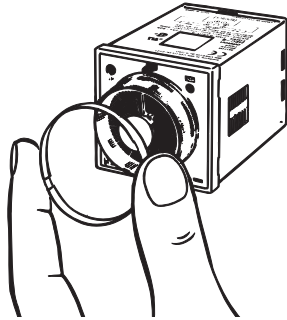

## Protective Cover

Y92A-48B

The protective cover shields the front panel, particularly the time setting section, from dust, dirt, and water, as well as prevents the set value from being altered due to accidental contact with the time setting knob.

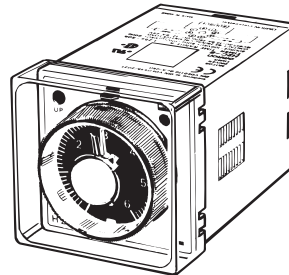

## Timer Hold-down Clips

Y92H-2  
(for PF085A/PF113A  
Connecting Socket)

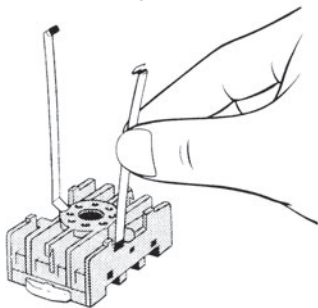

Y92H-1  
(for PL08/PL11  
Connecting Socket)

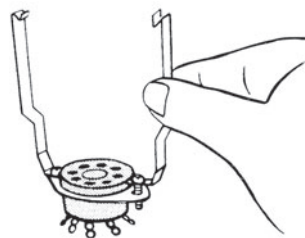

# Safety Precautions

Refer to *Safety Precautions for All Timers*.

## CAUTION

This may occasionally cause electric shock, fire, or malfunction. Never disassemble, repair, or modify the H2C.

This may occasionally cause electric shock, fire, or malfunction. Do not allow metal fragments or lead wire scraps to fall inside the H2C.

## Precautions for Safe Use

Observe the following items to ensure the safe use of this product.

### Environmental Precautions

- Store the H2C within the specified ratings. If the H2C has been stored at temperatures  $-10^{\circ}\text{C}$  or lower, let it stand for 3 hours or longer at room temperature before turning ON the power supply.
- Use the H2C within the specified ratings for operating temperature and humidity.
- Do not operate the H2C in locations subject to sudden or extreme changes in temperature, or locations where high humidity may result in condensation.
- Do not use the H2C in locations subject to vibrations or shock. Extended use in such locations may result in damage due to stress.
- Do not use the H2C in locations subject to excessive dust, corrosive gas, or direct sunlight.
- Install the H2C well away from any sources of static electricity, such as pipes transporting molding materials, powders, or liquids.
- The H2C is not waterproof or oil resistant. Do not use it in locations subject to water or oil.
- The life expectancy of internal components may be reduced if the H2C is mounted side-by-side.
- Do not use organic solvents (such as paint thinner or benzine), strong alkaline, or strong acids because they will damage the external finish.

### Usage Precautions

- Install a switch or circuit breaker that allows the operator to immediately turn OFF the power, and label it to clearly indicate its function.
- Be sure to wire the terminals correctly.
- Do not install input lines in the same duct or conduit as power supply or other high-voltage lines. Doing so may result in malfunction due to noise. Separate the input lines from high-voltage lines.
- Internal elements may be destroyed if a voltage outside the rated voltage is applied.
- Maintain voltage fluctuations in the power supply within the specified range.
- Use a switch, relay, or other contact so that the rated power supply voltage will be reached within 0.1 s. If the power supply voltage is not reached quickly enough, the H2C may malfunction or outputs may be unstable.
- Leaving the H2C with outputs ON at a high temperature for a long time may hasten the degradation of internal parts (such as electrolytic capacitors). Therefore, use the H2C in combination with relays and avoid leaving the H2C for more than 1 month with an output turned ON.

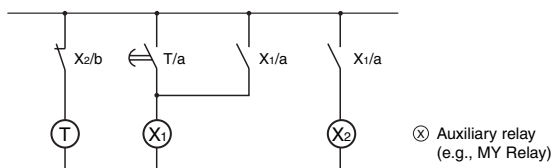

## Precautions for Correct Use

### How to Change the Time Range

Change the time range by turning the knob clockwise using a flat-blade screwdriver or an Allen wrench. There are five possible settings. The selected time is displayed in the time range display window above the knob.

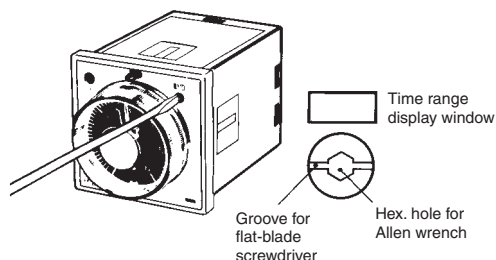

Do not change the time range while the timer is in operation.

### How to Select Power Frequency

Before using the timer, set the frequency selector located at the rear panel to the proper power frequency (50 to 60 Hz).

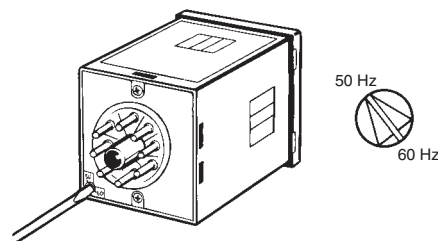

### How to Mount the Timer on Mounting Track

#### Mounting

First hook portion A of the timer to the mounting track, then press the timer in direction B.

#### Dismounting

Pull out portion C with a round-blade screwdriver and remove the timer from the mounting track.

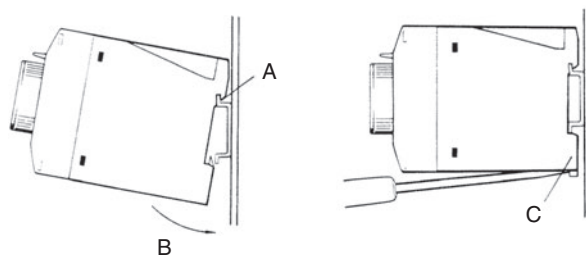

### Electrical Set

The motor and clutch do not need to be reset simultaneously.

Use the voltage applied to the clutch for resetting with the H2C-□R. Do not allow power to be continuously applied to the motor and clutch for extended periods of time.

## Others

Do not turn the operation time setting knob beyond the range of the scale. To achieve higher accuracy in setting, measure the operation time while turning the operation time setting knob.

The deviation and setting error for the operation time shows the percent of FS. The absolute value of the deviation and setting error will not change even if the set time is changed. The time specifications should therefore be selected to use the operation time as close to FS as possible.

At high temperatures, the operation voltage will be 90% or less if voltage is applied continuously after timeout. Be sure to keep the voltage within the allowable voltage fluctuation range.

## Precautions for EN61812-1

The H2C (except for H2C-F□) as a built-in timer conforms to EN61812-1, provided that the following conditions are satisfied.

### **Handling**

Before dismantling the H2C from the Socket, make sure that no voltage is imposed on any terminal of the H2C.

Applicable Sockets: P2CF-□□, P2CF-□□-E, PF085A, PL□□.

### **Wiring**

Basic insulation is ensured between the motor circuit, clutch circuit, and control output circuit. (However, the H2C-8 motor circuit and clutch circuit use the same input.) Basic insulation is also ensured between the output circuits of models with instantaneous output.

Basic insulation: Overvoltage category III, pollution degree 1 (See note.)

Operating parts: Reinforced insulation (double insulation)  
(with a clearance of 5.5 mm and a creepage distance of 5.5 mm at 240 VAC)

Output parts: Basic insulation  
(with a clearance of 3.0 mm and a creepage distance of 3.0 mm at 240 VAC)

**Note:** Overvoltage category II, pollution degree 1 if the Timer is mounted to the PL11 Socket.

ALL DIMENSIONS SHOWN ARE IN MILLIMETERS.

To convert millimeters into inches, multiply by 0.03937. To convert grams into ounces, multiply by 0.03527.

In the interest of product improvement, specifications are subject to change without notice.