

DWG. NO. SD-35312-**-** I*

SIMILAR ITEM

PROJECT NO.

C

B

DO NOT SCALE DRAWING
DIMENSION IN METRIC

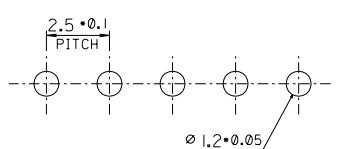
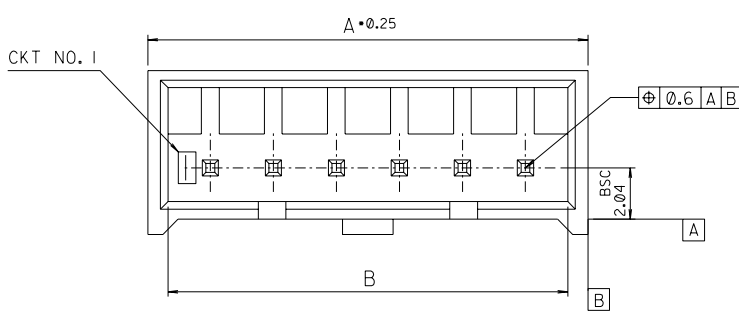
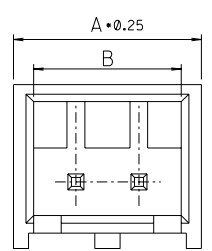

P.C. BOARD LAYOUT
THK. : 1.6T

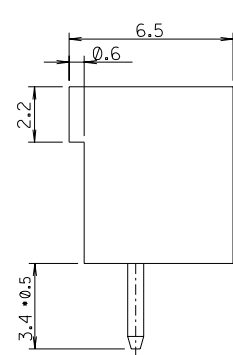
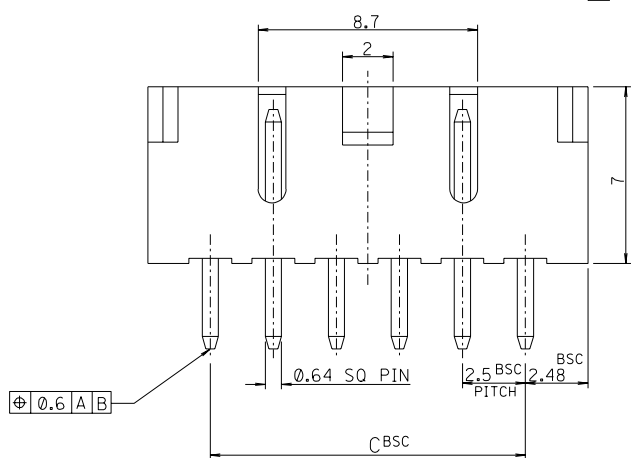
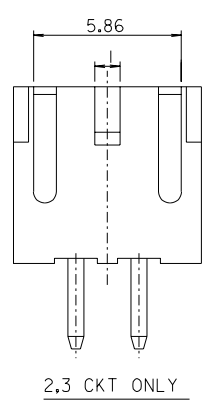

NOTE
I. MATERIAL: WAFER : NYLON66
PIN : BRASS

LEGEND
35312 - ** I*
COLOR : 0 --- NATURAL
2 --- RED
3 --- YELLOW
4 --- BLUE
CKT(02,03,04....)

35	38.36	39.96	35312-15I*	15
32.5	35.86	37.46	-14I*	14
30	33.36	34.96	-13I*	13
27.5	30.86	32.46	-12I*	12
25	28.36	29.96	-11I*	11
22.5	25.86	27.46	-10I*	10
20	23.36	24.96	-09I*	9
17.5	20.86	22.46	-08I*	8
15	18.36	19.96	-07I*	7
12.5	15.86	17.46	-06I*	6
10	13.36	14.96	-05I*	5
7.5	10.86	12.46	-04I*	4
5	8.36	9.96	-03I*	3
2.5	5.86	7.46	35312-02I*	2
C	B	A	ENG NO.	CKT NO.

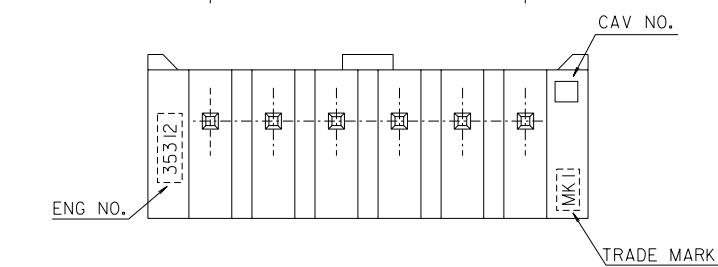

REVISED EC NO. KOR2005-0002 DRWN: K.S.KIM 040709 CHK: Y.SOO.KIM APPR: C.W.LEE	QUALITY SYMBOLS MAJOR = CRITICAL =	GENERAL TOLERANCES: (UNLESS SPECIFIED) mm INCH	SCALE 5-1 DESIGN UNITS <input checked="" type="checkbox"/> mm <input type="checkbox"/> INCH	THIRD ANGLE PROJECTION <input checked="" type="checkbox"/> mm ONLY	DIMENSIONS: <input type="checkbox"/> mm <input type="checkbox"/> INCH	SHT REV REVISION ON CAD ONLY	
	DESCRIPTION MAJOR = CRITICAL =	4 PLACES ±. INCH 3 PLACES ±. INCH 2 PLACES ±. INCH 1 PLACE ±0.2 INCH	ANGULAR: ± 2 °	DRAFT WHERE APPLICABLE MUST REMAIN WITHIN DIMENSIONS	DRAFT WHERE APPLICABLE MUST REMAIN WITHIN DIMENSIONS	THIS DRAWING CONTAINS INFORMATION THAT IS PROPRIETARY TO MOLEX INCORPORATED AND SHOULD NOT BE USED WITHOUT WRITTEN PERMISSION.	SIZE B
	REV G	DRAWN BY & DATE H.S.SHIN 96/06/28 CHECKED BY & DATE Y.SOO.KIM APPROVED BY & DATE C.W.LEE	CAD FILENAME SDA35312.DGN	MATERIAL NO. 35312**-**	DRAWING NO. SD-35312-**-**	SHEET NO. 1 OF 1	MXT-A3
	TITLE: 2.5 PITCH W/B CONN. WAFER ASS'Y (WITH LOCK)	MOLEX MOLEX INCORPORATED	THIS DRAWING CONTAINS INFORMATION THAT IS PROPRIETARY TO MOLEX INCORPORATED AND SHOULD NOT BE USED WITHOUT WRITTEN PERMISSION.	THIS DRAWING CONTAINS INFORMATION THAT IS PROPRIETARY TO MOLEX INCORPORATED AND SHOULD NOT BE USED WITHOUT WRITTEN PERMISSION.	THIS DRAWING CONTAINS INFORMATION THAT IS PROPRIETARY TO MOLEX INCORPORATED AND SHOULD NOT BE USED WITHOUT WRITTEN PERMISSION.	THIS DRAWING CONTAINS INFORMATION THAT IS PROPRIETARY TO MOLEX INCORPORATED AND SHOULD NOT BE USED WITHOUT WRITTEN PERMISSION.	THIS DRAWING CONTAINS INFORMATION THAT IS PROPRIETARY TO MOLEX INCORPORATED AND SHOULD NOT BE USED WITHOUT WRITTEN PERMISSION.

DWG. NO. SD-35312-006

SIMILAR ITEM

PROJECT NO.

C

B

DO NOT SCALE DRAWING
DIMENSION IN METRIC

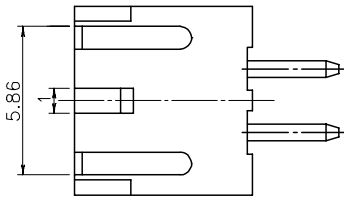
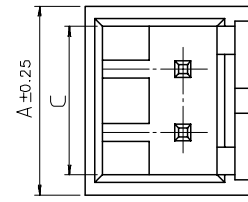

2,3 CKT ONLY

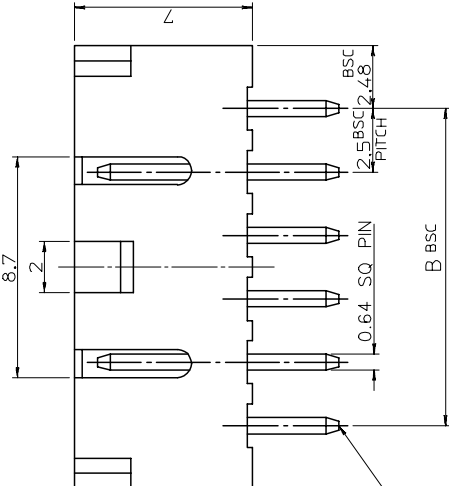
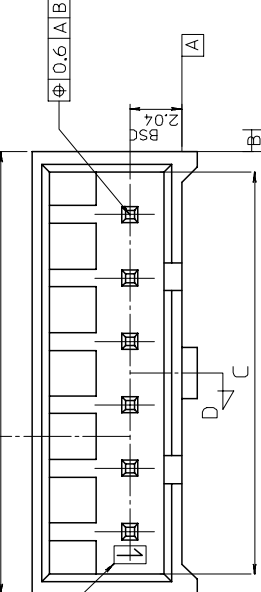

CAV. NO.

ENG NO.

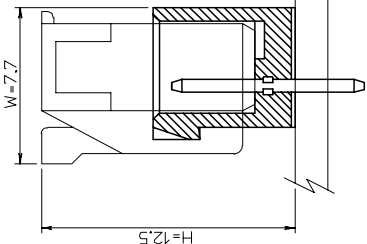

MATED VIEW

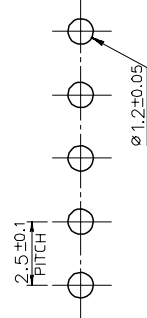

P.C. BOARD LAYOUT

THK. : 1.6t

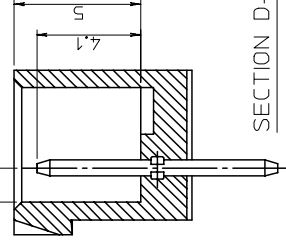
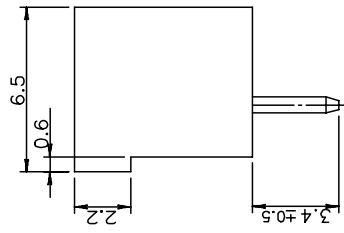

SECTION D-D

TRADE MARK

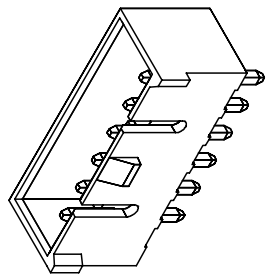

ISOMETRIC VIEW

NOTE

1. MATERIAL: WAFER : POLYAMIDE(PA), UL94V-0
PIN : BRASS, TIN PLATED
2. MATED WITH : 35155-*****

LEGEND

35312 - ** 1 x

- COLOR : 0 --- NATURAL
2 --- RED
3 --- YELLOW
4 --- BLUE
- CKT(02,03,04,....)

C	B	A	ENG NO.	CKT NO.
38.36	35	39.96	35312-151*	15
35.86	32.5	37.46	-141*	14
33.36	30	34.96	-131*	13
30.86	27.5	32.46	-121*	12
28.36	25	29.96	-111*	11
25.86	22.5	27.46	-101*	10
23.36	20	24.96	-091*	9
20.86	17.5	22.46	-081*	8
18.36	15	19.96	-071*	7
15.86	12.5	17.46	-061*	6
13.36	10	14.96	-051*	5
10.86	7.5	12.46	-041*	4
8.36	5	9.96	-031*	3
5.86	2.5	7.46	35312-021*	2

DIMENSIONS:		THIRD ANGLE PROJECTION		SHT		REV	
MM	INCH	MM	INCH	MM	INCH	MM	INCH
<input type="checkbox"/>	<input type="checkbox"/>	<input type="checkbox"/>	<input type="checkbox"/>	<input type="checkbox"/>	<input type="checkbox"/>	<input type="checkbox"/>	<input type="checkbox"/>

TITLE:

2.5 PITCH W/B CONN. WAFER ASS'Y
(WITH LOCK)

MOLEX INCORPORATED

MATERIAL NO.	DRAWING NO.	SHEET NO.
SEE TABLE	SD-35312-006	1 OF 1

THIS DRAWING CONTAINS INFORMATION THAT IS PROPRIETARY TO MOLEX INCORPORATED AND SHOULD NOT BE USED WITHOUT WRITTEN PERMISSION.

SIZE B
MX-A3

KOREA

2

3

4

5

6

7

8