

DWG. NO. SD-35312-006

SIMILAR ITEM

PROJECT NO.

B

DO NOT SCALE DRAWING  
DIMENSION IN METRIC

8 7 6 5 4 3 2 1

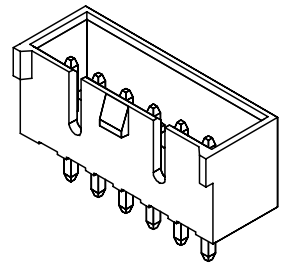
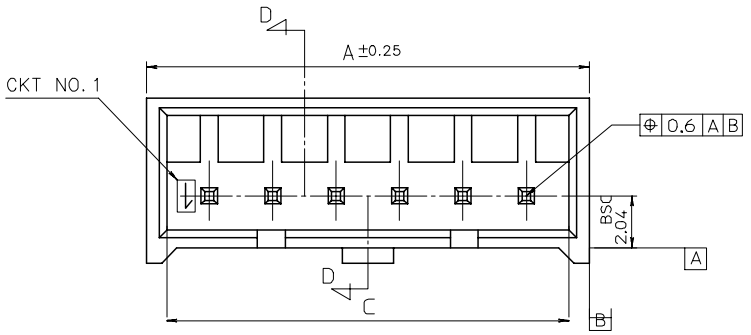
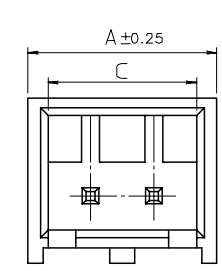

ISOMETRIC VIEW

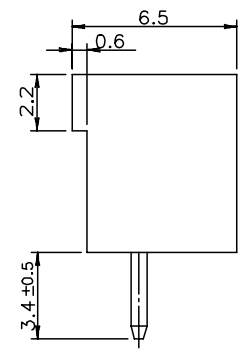
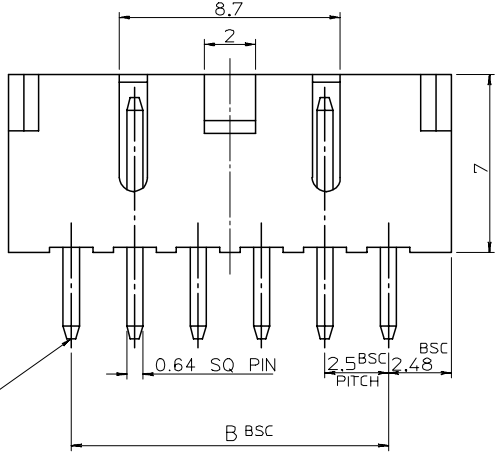
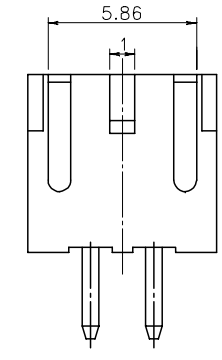

NOTE

- 1. MATERIAL: WAFER : POLYAMIDE(PA) . UL94V-0  
PIN : BRASS, TIN PLATED
- 2. MATED WITH : 35155-\*\*\*\*

LEGEND

35312 - \*\* 1 \*  
 COLOR : 0 --- NATURAL  
 2 --- RED  
 3 --- YELLOW  
 4 --- BLUE  
 CKT(02,03,04....)

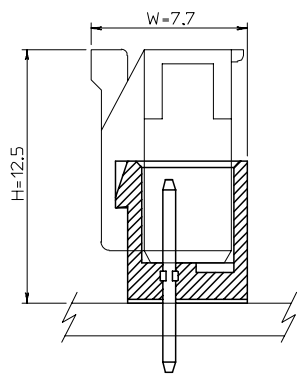

MATED VIEW

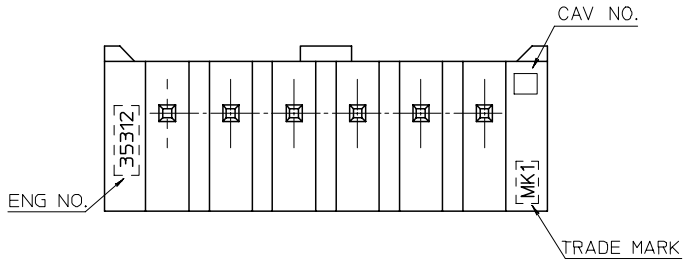

P.C. BOARD LAYOUT

THK. : 1.6t

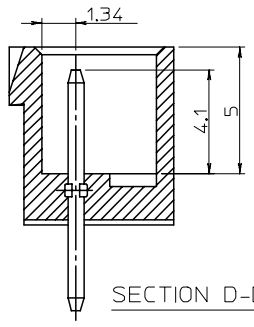

SECTION D-D

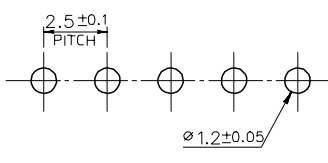

REVISED  
 ECN NO. KOR2005-0196  
 DRWN: K.S.KIM 0504/19  
 CHK: Y.Soo.KIM  
 APPR: C.W.LEE

QUALITY SYMBOLS  
 MAJOR  
 CRITICAL

GENERAL TOLERANCES:  
 (UNLESS SPECIFIED)

	mm	INCH
4 PLACES	±0.	±-
3 PLACES	±0.	±-
2 PLACES	±0.	±-
1 PLACE	±0.2	±-

ANGULAR: ± 2 °

DRAFT WHERE APPLICABLE MUST REMAIN WITHIN DIMENSIONS

SCALE 5-1  
 DESIGN UNITS  mm  INCH  
 DRAWN BY & DATE H.S.SHIN 96/06/28  
 CHECKED BY & DATE Y.Soo.KIM  
 APPROVED BY & DATE C.W.LEE  
 CAD FILENAME

THIRD ANGLE PROJECTION  
 DIMENSIONS:  mm  INCH  mm ONLY  
 TITLE: 2.5 PITCH W/B CONN. WAFER ASS'Y (WITH LOCK)  
 MOLEX INCORPORATED  
 MATERIAL NO. SEE TABLE  
 DRAWING NO. SD-35312-006  
 SHEET NO. 1 OF 1  
 REVISE ON CAD ONLY

38.36	35	39.96	35312-151*	15
35.86	32.5	37.46	-141*	14
33.36	30	34.96	-131*	13
30.86	27.5	32.46	-121*	12
28.36	25	29.96	-111*	11
25.86	22.5	27.46	-101*	10
23.36	20	24.96	-091*	9
20.86	17.5	22.46	-081*	8
18.36	15	19.96	-071*	7
15.86	12.5	17.46	-061*	6
13.36	10	14.96	-051*	5
10.86	7.5	12.46	-041*	4
8.36	5	9.96	-031*	3
5.86	2.5	7.46	35312-021*	2
C	B	A	ENG NO.	CKT NO.

8 7 6 5 4 3 2 1 KOREA MX-A3