

**PLEASE CHECK WWW.MOLEX.COM FOR LATEST PART INFORMATION**

**Part Number:** **0430450619**  
**Status:** **Active**  
**Overview:** Micro-Fit 3.0 Connector System Product Family  
**Description:** Micro-Fit 3.0™ Vertical Header, 3.00mm Pitch, Dual Row, 6 Circuits, with Solder Tab, Gold, Glow Wire Capable, Black

**Documents:**

<a href="#">3D Model</a>	<a href="#">Product Specification TS-43045-002-001 (PDF)</a>
<a href="#">Drawing (PDF)</a>	<a href="#">Product Specification TS-46235-001-001 (PDF)</a>
<a href="#">Product Specification PS-43045 (PDF)</a>	<a href="#">RoHS Certificate of Compliance (PDF)</a>
<a href="#">Product Specification TS-43045-001-001 (PDF)</a>	<a href="#">Product Literature (PDF)</a>

**Agency Certification**

CSA	LR19980
UL	E29179

**General**

Product Family	PCB Headers
Series	43045
Application	Power, Wire-to-Board
Comments	"High Temperature Square Pin Solder Type<P><P>This Molex product is manufactured from material that has the following ratings, tested by independent agencies:. a) A Glow Wire Ignition Temperature (GWIT) of at least 775 deg C per IEC 60695-2-13.. b) A Glow Wire Flammability Index (GWFI) above 850 deg C per IEC 60695-2-12.and hence complies with the requirements set out in the International Standard IEC 60335-1 5th edition - household and similar electrical appliances - safety, section 30 Resistance to heat and fire. <P><P> The customers using this product must determine its suitability for use in their particular application through testing or other acceptable means as described in end-product glow-wire flammability test standard IEC 60695-2-11 and any applicable product end-use standard(s). <P> If it is determined during the customer's evaluation of suitability, that higher performance is required, please contact Molex for possible product options."

**Overview**

Product Literature Order No	<a href="#">Micro-Fit 3.0 Connector System Product Family</a>
Product Name	987650-5984
UPC	Micro-Fit 3.0™ 800753816237

**Physical**

Breakaway	No
Circuits (Loaded)	6
Circuits (maximum)	6
Color - Resin	Black
Durability (mating cycles max)	30
Flammability	94V-0
Glow-Wire Compliant	Yes
Mated Height	17.64mm
Material - Metal	Brass
Material - Plating Mating	Gold
Material - Plating Termination	Tin
Material - Resin	High Temperature Thermoplastic

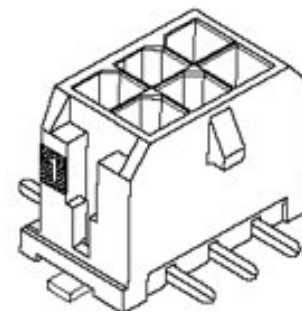

Series image - Reference only

**EU ELV**

**Not Relevant**

**EU RoHS**

**Compliant**

**REACH SVHC**

Not Contained Per - ED/30/2017 (7 July 2017)

**Halogen-Free**

**Status**

**Low-Halogen**

**Need more information on product environmental compliance?**

Email [productcompliance@molex.com](mailto:productcompliance@molex.com)  
Please visit the [Contact Us](#) section for any non-product compliance questions.

China ROHS

ELV

RoHS Phthalates

Green Image

Not Relevant

Not Contained

**Search Parts in this Series**

[43045 Series](#)

**Mates With**

Micro-Fit 3.0™ Receptacle Housing [43025](#)  
<br>Micro-Fit TPA Receptacle Housing [172952](#)

Net Weight	1.214/g
Number of Rows	2
Orientation	Vertical
PCB Locator	Yes
PCB Retention	Yes
PCB Thickness - Recommended	1.60mm
Packaging Type	Embossed Tape on Reel
Pitch - Mating Interface	3.00mm
Plating min - Mating	0.381µm
Polarized to PCB	Yes
Shrouded	Fully
Stackable	No
Surface Mount Compatible (SMC)	N/A
Temperature Range - Operating	-40°C to +105°C
Termination Interface: Style	Surface Mount
<b>Electrical</b>	
Current - Maximum per Contact	5.0A
Voltage - Maximum	600V
<b>Solder Process Data</b>	
Duration at Max. Process Temperature (seconds)	030
Lead-free Process Capability	REFLOW
Max. Cycles at Max. Process Temperature	003
Process Temperature max. C	260
<b>Material Info</b>	
<b>Reference - Drawing Numbers</b>	
Product Specification	PS-43045, TS-43045-001-001, TS-43045-002-001, TS-46235-001-001
Sales Drawing	SD-43045-007

This document was generated on 09/28/2017

**PLEASE CHECK [WWW.MOLEX.COM](http://WWW.MOLEX.COM) FOR LATEST PART INFORMATION**