

PLEASE CHECK WWW.MOLEX.COM FOR LATEST PART INFORMATION

Part Number: [5022503991](#)
Status: **Active**
Description: 0.30mm Pitch Easy-On™ BackFlip™ FPC Connector, Right Angle, SMT, Dual Contact Style, 0.90mm Mated Height, 39 Circuits

Documents:

[3D Model](#) [Packaging Specification SPK-502250-001 \(PDF\)](#)
[Drawing \(PDF\)](#) [RoHS Certificate of Compliance \(PDF\)](#)
[Product Specification PS-502250-001 \(PDF\)](#)

General

Product Family FFC/FPC Connectors
 Series [502250](#)
 Product Name BackFlip™, Easy-On™

Physical

Circuits (Loaded) 39
 Color - Resin Black, Natural
 Contact Position Dual
 Durability (mating cycles max) 10
 Entry Angle 90° Angle
 Mated Height 0.90mm
 Material - Metal Copper-Nickel-Tin
 Material - Plating Mating Gold
 Material - Plating Termination Gold
 Number of Rows 1
 Orientation Right Angle
 PCB Locator No
 PCB Retention Yes
 Packaging Type Embossed Tape on Reel
 Pitch - Mating Interface 0.30mm
 Polarized to PCB Yes
 Stackable No
 Temperature Range - Operating -25°C to +85°C
 Termination Interface: Style Surface Mount
 Wire/Cable Type FPC only

Electrical

Current - Maximum per Contact 0.2A
 Voltage - Maximum 50V AC (RMS)/DC

Material Info

Reference - Drawing Numbers

Packaging Specification SPK-502250-001
 Product Specification PS-502250-001, RPS-502250-002, RPS-502250-003, RPS-502250-005, RPS-502250-007
 Sales Drawing SD-502250-003, SD-502250-004

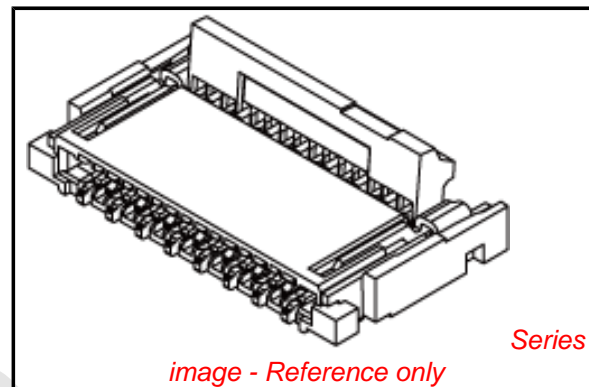

EU RoHS

ELV and RoHS Compliant
REACH SVHC Contains SVHC: No
Low-Halogen Status
Not Low-Halogen

China RoHS



Need more information on product environmental compliance?

Email productcompliance@molex.com
 For a multiple part number RoHS Certificate of Compliance, [click here](#)

Please visit the [Contact Us](#) section for any non-product compliance questions.

Search Parts in this Series
[502250Series](#)