

PLEASE CHECK WWW.MOLEX.COM FOR LATEST PART INFORMATION

Part Number: **5023801400**
Status: **Active**
Overview: CLIK-Mate™ Wire-to-Board Connectors
Description: 1.25mm Pitch CLIK-Mate™ Wire-to-Board Housing, Single Row, Positive Lock, 14 Circuits

Documents:

3D Model	Application Specification AS-502380-001-001 (PDF)
Drawing (PDF)	Application Specification AS-502380-002-001 (PDF)
Product Specification PS-502382-001-001 (PDF)	RoHS Certificate of Compliance (PDF)
Product Specification PS-502382-002-001 (PDF)	

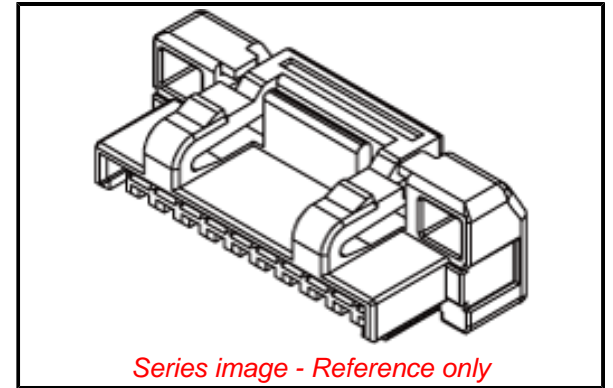

General

Product Family	Crimp Housings
Series	502380
Application	Signal, Wire-to-Board
Overview	<u>CLIK-Mate™ Wire-to-Board Connectors</u>
Product Name	CLIK-Mate™
UPC	822350895163

Physical

Breakaway	No
Circuits (maximum)	14
Color - Resin	White
Gender	Plug
Glow-Wire Compliant	No
Keying to Mating Part	Yes
Lock to Mating Part	Yes
Material - Resin	Polyester
Net Weight	337.000/mg
Number of Rows	1
Packaging Type	Bag
Panel Mount	No
Pitch - Mating Interface	1.25mm
Polarized to Mating Part	Yes
Stackable	No
Temperature Range - Operating	-40°C to +105°C

Electrical

Current - Maximum per Contact	1.0A
-------------------------------	------

Material Info

Reference - Drawing Numbers

Application Specification	AS-502380-001-001, AS-502380-002-001
Product Specification	PS-502382-001-001, PS-502382-002-001
Sales Drawing	SD-502380-001, SD-502380-002

EU ELV

Not Relevant

EU RoHS

Compliant

REACH SVHC

Not Contained Per -
ED/30/2017 (7 July
2017)

Halogen-Free

Status

Not Low-Halogen

Need more information on product environmental compliance?

Email productcompliance@molex.com
Please visit the [Contact Us](#) section for any non-product compliance questions.

China ROHS	Green Image
ELV	Not Relevant
RoHS Phthalates	Not Contained

Search Parts in this Series

[502380](#) Series

Mates With

[502382](#) PCB Receptacle, [502386](#) PCB Receptacle

Use With

[502381](#) Crimp Terminal