

**PLEASE CHECK WWW.MOLEX.COM FOR LATEST PART INFORMATION**

**Part Number:** [0196001302](#)  
**Status:** **Active**  
**Overview:** Standard Quick-Disconnect Terminals  
**Description:** Avikrimp™ Fully Insulated Female Quick Disconnect

**Documents:**

[3D Model](#) [Product Specification PS-19902-014-001 \(PDF\)](#)  
[Drawing \(PDF\)](#) [RoHS Certificate of Compliance \(PDF\)](#)  
[Product Specification PS-19902-013-001 \(PDF\)](#)

**Agency Certification**

CSA LR18689  
 UL E79133

**General**

Product Family Quick Disconnects  
 Series [19600](#)  
 Crimp Quality Equipment Yes  
 Insulated Fully  
 Overview [Standard Quick-Disconnect Terminals](#)  
 Product Name Avikrimp™  
 Type Quick Disconnect  
 UPC 800753117785

**Physical**

Barrel Type Closed  
 Color - Resin Yellow  
 Flammability 94V-2  
 Gender Female  
 Glow-Wire Compliant No  
 Insulation Nylon (PA)  
 Lock to Mating Part None  
 Material - Metal Brass  
 Material - Plating Mating Tin  
 Material - Plating Termination Tin  
 Net Weight 1.198/g  
 Orientation Straight  
 Packaging Type Bag  
 Polarized to Mating Part No  
 Tab Thickness 0.51mm  
 Tab Width 4.75mm  
 Temperature Range - Operating -65°C to +105°C  
 Wire Insulation Diameter 6.89x4.32mm max.  
 Wire Size AWG 16+16, 18+18, 20+20, 22+22

**Electrical**

Voltage - Maximum 300V

**Solder Process Data**

Lead-free Process Capability N/A

**Material Info**

Engineering Number P-5239

**Reference - Drawing Numbers**

Product Specification PS-19902-013-001, PS-19902-014-001  
 Sales Drawing SD-19600-1300

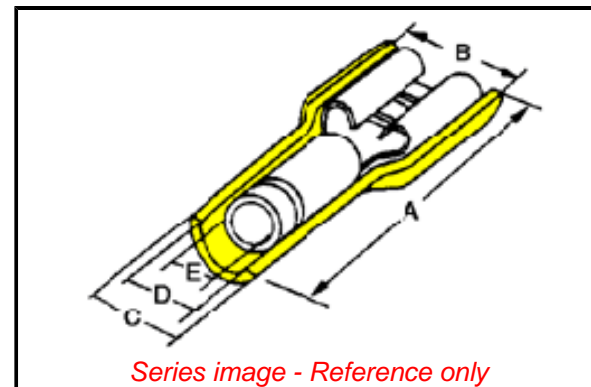

**EU ELV**

**Not Relevant**

**EU RoHS**

**Compliant**

**REACH SVHC**

Not Contained Per -  
 ED/108/2014 (17 Dec  
 2014)

**Halogen-Free**

**Status**

**Low-Halogen**

**Need more information on product  
 environmental compliance?**

Email [productcompliance@molex.com](mailto:productcompliance@molex.com)  
 Please visit the [Contact Us](#) section for any  
 non-product compliance questions.

China ROHS

ELV

RoHS Phthalates

Green Image

Not Relevant

Not Contained

**Search Parts in this Series**

[19600 Series](#)

This document was generated on 05/19/2017

**PLEASE CHECK [WWW.MOLEX.COM](http://WWW.MOLEX.COM) FOR LATEST PART INFORMATION**