

PLEASE CHECK WWW.MOLEX.COM FOR LATEST PART INFORMATION

Part Number: [0855135013](#)
Status: **Active**
Overview: Magnetic and Modular Jacks and Plugs
Description: Modular Jack, Vertical, Top Entry, Surface Mount, 8/8, Low Profile, 13" Reel

Documents:

3D Model	Test Summary STR-1425-001 (PDF)
Drawing (PDF)	RoHS Certificate of Compliance (PDF)
Product Specification PS-85513-002-001 (PDF)	Product Literature (PDF)
Application Specification AS-85513-001-001 (PDF)	

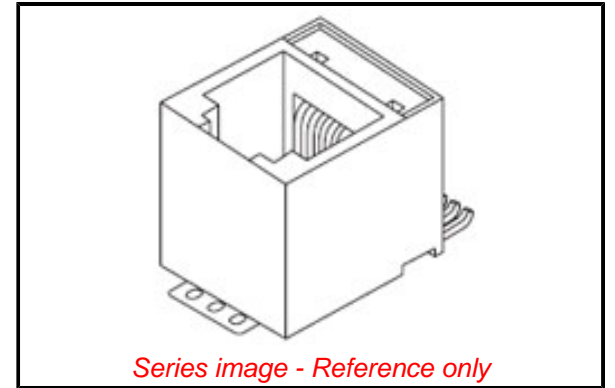

Agency Certification

UL E107635

General

Product Family	Modular Jacks/Plugs
Series	85513
Comments	Reflow Capable, Small Panel Cutout
Component Type	PCB Jack
Magnetic	No
Overview	<u>Magnetic and Modular Jacks and Plugs</u>
Performance Category	3
Power over Ethernet (PoE)	N/A
Product Literature Order No	987650-8441
Product Name	Modular Jack 8/8
UPC	822350834544

Physical

Boot Color	N/A
Color - Resin	Black
Durability (mating cycles max)	2500
Flammability	94V-0
Inverted / Top Latch	No
Jack Height	12.70mm
Lightpipes/LEDs	None
Material - Metal	Copper Alloy
Material - Plating Mating	Gold over Palladium Nickel
Material - Plating Termination	Tin
Material - Resin	High Temperature Thermoplastic
Net Weight	2.879/g
Orientation	Vertical (Top Entry)
PCB Locator	No
PCB Retention	Yes
Packaging Type	Embossed Tape on Reel
Pitch - Mating Interface	1.02mm
Pitch - Termination Interface	1.27mm
Plating min - Mating	0.051µm, 1.016µm
Plating min - Termination	1.905µm
Ports	1
Positions / Loaded Contacts	8/8
Surface Mount Compatible (SMC)	Yes
Temperature Range - Operating	-40°C to +85°C
Termination Interface: Style	Surface Mount
Waterproof / Dustproof	No
Wire/Cable Type	N/A

Electrical

EU ELV

Not Relevant

EU RoHS

Compliant

REACH SVHC

Not Contained Per -
ED/30/2017 (7 July
2017)

Halogen-Free

Status

Low-Halogen

Need more information on product environmental compliance?

Email productcompliance@molex.com
Please visit the [Contact Us](#) section for any non-product compliance questions.

China ROHS

ELV

RoHS Phthalates

Green Image

Not Relevant

Not Contained

Search Parts in this Series

[85513 Series](#)

Mates With

[90075 Modular Plug](#)

Current - Maximum per Contact	1.5A
Shielded	No
Voltage - Maximum	125V DC

Solder Process Data

Duration at Max. Process Temperature (seconds)	045
Lead-free Process Capability	REFLOW
Max. Cycles at Max. Process Temperature	003
Process Temperature max. C	260

Material Info**Reference - Drawing Numbers**

Application Specification	AS-85513-001-001
Product Specification	PS-85513-002-001
Sales Drawing	SD-85513-010
Test Summary	STR-1425-001

This document was generated on 08/03/2017

PLEASE CHECK WWW.MOLEX.COM FOR LATEST PART INFORMATION