

**PLEASE CHECK WWW.MOLEX.COM FOR LATEST PART INFORMATION**

**Part Number:** [0559172210](#)  
**Status:** **Active**  
**Overview:** MicroClasp™ Wire-to-Board System  
**Description:** 2.00mm Pitch MicroClasp™ Wire-to-Board Header, Dual Row, Vertical, 22 Circuits, with PCB Locator

**Documents:**

[3D Model](#) [Product Specification PS-51353-003-001 \(PDF\)](#)  
[Drawing \(PDF\)](#) [RoHS Certificate of Compliance \(PDF\)](#)

**Agency Certification**

UL E29179

**General**

Product Family PCB Headers  
 Series [55917](#)  
 Application Signal, Wire-to-Board  
 Overview [MicroClasp™ Wire-to-Board System](#)  
 Product Name MicroClasp™  
 UPC 800756610986

**Physical**

Breakaway No  
 Circuits (Loaded) 22  
 Circuits (maximum) 22  
 Color - Resin Natural  
 Durability (mating cycles max) 30  
 First Mate / Last Break No  
 Flammability 94V-0  
 Glow-Wire Compliant No  
 Guide to Mating Part No  
 Keying to Mating Part None  
 Lock to Mating Part Yes  
 Material - Plating Mating Tin  
 Material - Plating Termination Tin  
 Material - Resin Polyester  
 Net Weight 1638.900/mg  
 Number of Rows 2  
 Orientation Vertical  
 PC Tail Length 3.20mm  
 PCB Locator Yes  
 PCB Retention Yes  
 PCB Thickness - Recommended 1.60mm  
 Packaging Type Tray  
 Pitch - Mating Interface 2.00mm  
 Shrouded Fully  
 Stackable No  
 Surface Mount Compatible (SMC) No  
 Temperature Range - Operating -25°C to +85°C  
 Termination Interface: Style Through Hole

**Electrical**

Current - Maximum per Contact 3.0A  
 Voltage - Maximum 250V

**Material Info**

**Reference - Drawing Numbers**

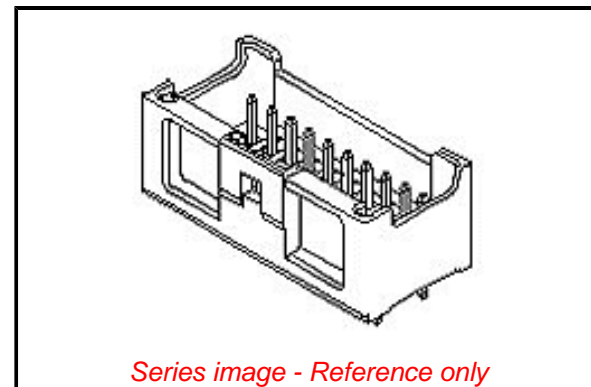

*Series image - Reference only*

**EU ELV**

**Not Relevant**

**EU RoHS**

**Compliant**

**China RoHS**

**REACH SVHC**

Not Contained Per  
 -ED/01/2017 (12  
 January 2017)

**Halogen-Free**

**Status**

**Not Low-Halogen**

**Need more information on product environmental compliance?**

Email [productcompliance@molex.com](mailto:productcompliance@molex.com)  
 Please visit the [Contact Us](#) section for any non-product compliance questions.

China ROHS	Green Image
ELV	Not Relevant
RoHS Phthalates	Not Contained

**Search Parts in this Series**

[55917 Series](#)

**Mates With**

[51353 MicroClasp™ Wire-to-Board Receptacle Housing](#)

This document was generated on 07/24/2017

**PLEASE CHECK [WWW.MOLEX.COM](http://WWW.MOLEX.COM) FOR LATEST PART INFORMATION**