

PLEASE CHECK WWW.MOLEX.COM FOR LATEST PART INFORMATION

Part Number: **0190190011**
Status: **Active**
Overview: Standard Quick-Disconnect Terminals
Description: Avikrimp™ Quick Disconnect, Female, for 18-22 (0.80-0.35mm²) Wire, Mylar Tape, Tab 4.75 x 0.51mm

Documents:

[Drawing \(PDF\)](#) [Product Specification PS-19902-015-001 \(PDF\)](#)
[Product Specification PS-19902-011-001 \(PDF\)](#) [RoHS Certificate of Compliance \(PDF\)](#)
[Product Specification PS-19902-014-001 \(PDF\)](#)

Agency Certification

CSA LR18689
 UL E79133

General

Product Family Quick Disconnects
 Series 19019
 Crimp Quality Equipment Yes
 Insulated Partial
 Overview Standard Quick-Disconnect Terminals
 Product Name Avikrimp™
 Type Quick Disconnect
 UPC 800753037908

Physical

Barrel Type Closed
 Color - Resin Red
 Flammability 94V-2
 Gender Female
 Glow-Wire Compliant No
 Insulation Nylon (PA)
 Lock to Mating Part None
 Material - Metal Brass
 Material - Plating Mating Tin
 Material - Plating Termination Tin
 Net Weight 0.716/g
 Orientation Straight
 Packaging Type Adhesive Tape on Reel
 Polarized to Mating Part No
 Tab Thickness 0.51mm
 Tab Width 4.75mm
 Temperature Range - Operating -65°C to +105°C
 Wire Insulation Diameter 2.90mm max.
 Wire Size AWG 18, 20, 22

Electrical

Voltage - Maximum 300V

Solder Process Data

Lead-free Process Capability N/A

Material Info

Engineering Number AA-8137T

Reference - Drawing Numbers

Product Specification PS-19902-011-001, PS-19902-014-001, PS-19902-015-001

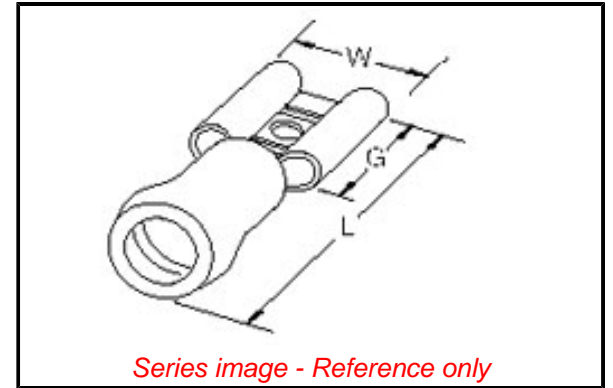

EU ELV

Not Relevant

EU RoHS

Compliant

REACH SVHC

Not Contained Per
 -ED/01/2017 (12
 January 2017)

Halogen-Free

Status

Not Low-Halogen

Need more information on product environmental compliance?

Email productcompliance@molex.com
 Please visit the [Contact Us](#) section for any non-product compliance questions.

China ROHS

ELV

RoHS Phthalates

Green Image

Not Relevant

Not Contained

Search Parts in this Series

19019 Series

This document was generated on 07/24/2017

PLEASE CHECK WWW.MOLEX.COM FOR LATEST PART INFORMATION