

PLEASE CHECK WWW.MOLEX.COM FOR LATEST PART INFORMATION

Part Number: [0039532104](#)
Status: **Active**
Overview: FFC-FPC (Through-Hole)
Description: FFC/FPC Connector, Through-Hole, Right-Angle, ZIF, Top Contact Style, 10 Circuits

Documents:

[3D Model](#) [Packaging Specification SPK-5597-003-001 \(PDF\)](#)
[Drawing \(PDF\)](#) [RoHS Certificate of Compliance \(PDF\)](#)
[Product Specification PS-5597-004-001 \(PDF\)](#)

Agency Certification

UL E29179

General

Product Family FFC/FPC Connectors
 Series [5597](#)
 Overview [FFC-FPC \(Through-Hole\)](#)
 Product Name N/A
 UPC 822348170173

Physical

Circuits (Loaded) 10
 Color - Resin Natural
 Contact Position Top
 Durability (mating cycles max) 30
 Entry Angle 90° Angle
 Flammability 94V-0
 Mated Height 5.00mm
 Material - Metal Phosphor Bronze
 Material - Plating Mating Tin-Bismuth
 Material - Plating Termination Tin-Bismuth
 Material - Resin Polyester
 Net Weight 958.440/mg
 Number of Rows 1
 Orientation Right Angle
 PC Tail Length 3.50mm
 PCB Locator No
 PCB Retention None
 Packaging Type Tray
 Pitch - Mating Interface 1.25mm
 Plating min - Mating 1.016µm
 Plating min - Termination 1.016µm
 Polarized to PCB No
 Stackable No
 Surface Mount Compatible (SMC) No
 Temperature Range - Operating -20°C to +80°C
 Termination Interface: Style Through Hole
 Wire/Cable Type FFC/FPC

Electrical

Current - Maximum per Contact 1.0A
 Voltage - Maximum 200V

Material Info

Engineering Number 5597-10APB7F

Reference - Drawing Numbers

Packaging Specification SPK-5597-003-001

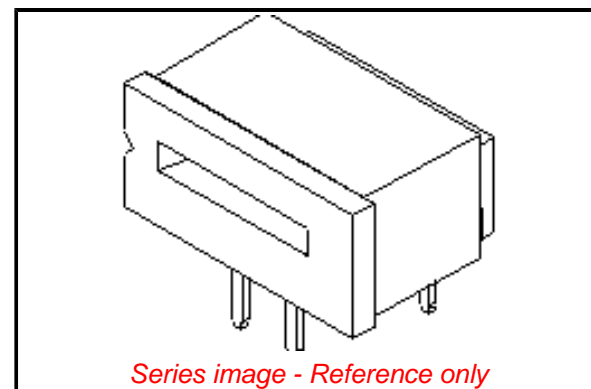

Series image - Reference only

EU ELV

Not Relevant

EU RoHS

Compliant

REACH SVHC

Not Contained Per -
 ED/30/2017 (7 July
 2017)

Halogen-Free

Status

Not Low-Halogen

**Need more information on product
 environmental compliance?**

Email productcompliance@molex.com
 Please visit the [Contact Us](#) section for any
 non-product compliance questions.

China ROHS

ELV

RoHS Phthalates

Green Image

Not Relevant

Not Contained

Search Parts in this Series

[5597 Series](#)

This document was generated on 07/31/2017

PLEASE CHECK WWW.MOLEX.COM FOR LATEST PART INFORMATION