

PLEASE CHECK WWW.MOLEX.COM FOR LATEST PART INFORMATION

Part Number: [5015680207](#)
Status: **Active**
Overview: Pico-Clasp™ Wire-to-Board Connectors
Description: 1.00mm Pitch Pico-Clasp™ Wire-to-Board Header, Surface Mount, Single Row, Right Angle, Tin Plated, with Inner Friction Lock, 2 Circuits

Documents:

[3D Model](#) [Packaging Specification SPK-501568-001-001 \(PDF\)](#)
[Drawing \(PDF\)](#) [RoHS Certificate of Compliance \(PDF\)](#)
[Product Specification PS-501568-001-001 \(PDF\)](#)

Agency Certification

UL E29179

General

Product Family PCB Headers
 Series [501568](#)
 Application Signal, Wire-to-Board
 Overview [Pico-Clasp™ Wire-to-Board Connectors](#)
 Product Name Pico-Clasp™
 UPC 822348871780

Physical

Breakaway No
 Circuits (Loaded) 2
 Circuits (maximum) 2
 Color - Resin Natural
 Durability (mating cycles max) 30
 Glow-Wire Compliant No
 Lock to Mating Part Yes
 Material - Metal Phosphor Bronze
 Material - Plating Mating Tin
 Material - Plating Termination Tin
 Material - Resin Nylon
 Net Weight 78.900/mg
 Number of Rows 1
 Orientation Right Angle
 PCB Locator No
 PCB Retention Yes
 Packaging Type Embossed Tape on Reel
 Pitch - Mating Interface 1.00mm
 Polarized to Mating Part Yes
 Polarized to PCB No
 Stackable No
 Temperature Range - Operating -40°C to +105°C
 Termination Interface: Style Surface Mount

Electrical

Current - Maximum per Contact 1.0A
 Voltage - Maximum 50V AC (RMS)/DC

Material Info

Reference - Drawing Numbers

Packaging Specification SPK-501568-001-001
 Product Specification PS-501568-001-001
 Sales Drawing SD-501568-001, SD-501568-005

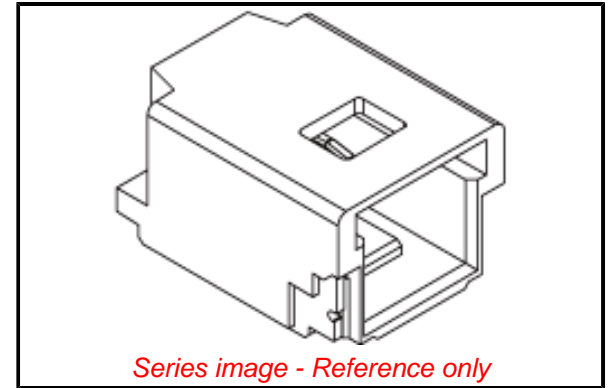

Series image - Reference only

EU ELV

Not Relevant

EU RoHS

Compliant

REACH SVHC

Not Contained Per -
 ED/30/2017 (7 July
 2017)

Halogen-Free

Status

Not Low-Halogen

**Need more information on product
 environmental compliance?**

Email productcompliance@molex.com
 Please visit the [Contact Us](#) section for any
 non-product compliance questions.

China ROHS

ELV

RoHS Phthalates

China RoHS

Green Image

Not Relevant

Not Contained

Search Parts in this Series

[501568](#) Series

Mates With

[501330](#) Pico-Clasp™ Wire-to-Board Female
 Housing

This document was generated on 08/01/2017

PLEASE CHECK WWW.MOLEX.COM FOR LATEST PART INFORMATION