

PLEASE CHECK WWW.MOLEX.COM FOR LATEST PART INFORMATION

Part Number: **0533071471**
Status: **Active**
Description: 0.80mm Pitch Header, Surface Mount, Dual Row, Vertical Stacking, 4.50 and 5.50mm Stacking Heights, 14 Circuits

Documents:

3D Model	Product Specification PS-52588-031-001 (PDF)
Drawing (PDF)	Packaging Specification SPK-53307-001-001 (PDF)
Product Specification PS-52465-015-001 (PDF)	RoHS Certificate of Compliance (PDF)

General

Product Family	PCB Headers
Series	53307
Application	Board-to-Board, Signal
Product Name	N/A
UPC	822348180455

Physical

Breakaway	No
Circuits (Loaded)	14
Circuits (maximum)	14
Color - Resin	Natural
First Mate / Last Break	No
Glow-Wire Compliant	No
Guide to Mating Part	No
Keying to Mating Part	None
Lock to Mating Part	None
Mated Height	4.50mm, 5.50mm
Material - Metal	Phosphor Bronze
Material - Plating Mating	Tin
Material - Plating Termination	Tin
Material - Resin	High Temperature Thermoplastic
Net Weight	213.300/mg
Number of Rows	2
Orientation	Vertical
PCB Locator	No
PCB Retention	None
Packaging Type	Embossed Tape on Reel
Pitch - Mating Interface	0.80mm
Pitch - Termination Interface	0.80mm
Plating min - Mating	3.048µm
Plating min - Termination	3.048µm
Polarized to PCB	No
Shrouded	Fully
Stackable	No
Temperature Range - Operating	-40°C to +105°C
Termination Interface: Style	Surface Mount

Electrical

Current - Maximum per Contact	0.5A
Voltage - Maximum	50V

Material Info

Reference - Drawing Numbers

Packaging Specification	SPK-53307-001-001
Product Specification	PS-52465-015-001, PS-52588-031-001
Sales Drawing	SD-53307-014, SD-53307-015

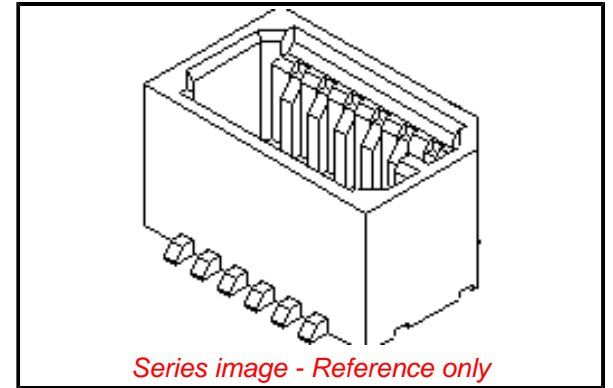

EU ELV

Not Relevant

EU RoHS

Compliant

REACH SVHC

Not Contained Per -
ED/30/2017 (7 July
2017)

Halogen-Free

Status

Not Low-Halogen

Need more information on product environmental compliance?

Email productcompliance@molex.com
Please visit the [Contact Us](#) section for any non-product compliance questions.

China ROHS

ELV

RoHS Phthalates

Green Image

Not Relevant

Not Contained

Search Parts in this Series

[53307 Series](#)

Mates With

Board-to-Board Receptacle [52465](#) , [52588](#)

This document was generated on 08/02/2017

PLEASE CHECK WWW.MOLEX.COM FOR LATEST PART INFORMATION