

PLEASE CHECK WWW.MOLEX.COM FOR LATEST PART INFORMATION

Part Number: [5019312070](#)
Status: **Active**
Overview: Duo-Clasp™ Wire-to-Board System
Description: 1.25mm Pitch Duo-Clasp™ Wire-to-Board PCB Receptacle, Dual Row, Vertical, 0.10µm Gold (Au) Plating, 20 Circuits

Documents:

3D Model	Application Specification AS-503110-002-001 (PDF)
Drawing (PDF)	Packaging Specification SPK-501931-001-001 (PDF)
Product Specification PS-501931-002-001 (PDF)	RoHS Certificate of Compliance (PDF)
Application Specification AS-503110-001-001 (PDF)	

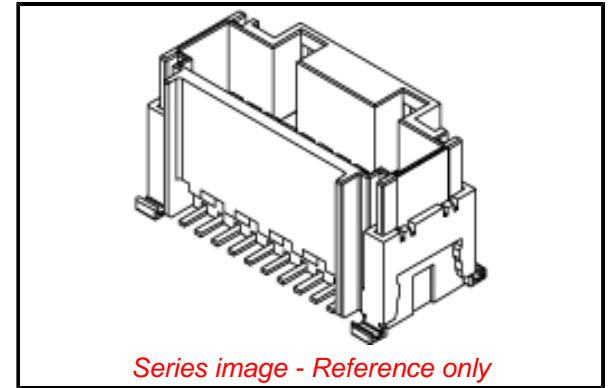

Agency Certification

UL E29179

General

Product Family	PCB Receptacles
Series	501931
Application	Signal, Wire-to-Board
Overview	Duo-Clasp™ Wire-to-Board System
Product Name	Duo-Clasp™
UPC	822350236089

Physical

Circuits (Loaded)	20
Circuits (maximum)	20
Color - Resin	Natural
Durability (mating cycles max)	30
Glow-Wire Compliant	No
Guide to Mating Part	Yes
Keying to Mating Part	Yes
Lock to Mating Part	Yes
Mated Height	10.95mm
Material - Metal	Copper Alloy
Material - Plating Mating	Gold
Material - Plating Termination	Tin
Net Weight	1058.100/mg
Number of Rows	2
Orientation	Vertical
PCB Locator	No
PCB Retention	Yes
Packaging Type	Embossed Tape on Reel
Pitch - Mating Interface	1.25mm
Plating min - Mating	0.100µm
Plating min - Termination	1.000µm
Polarized to Mating Part	Yes
Polarized to PCB	No
Stackable	No
Temperature Range - Operating	-25°C to +85°C
Termination Interface: Style	Surface Mount

Electrical

Current - Maximum per Contact	1.0A
Voltage - Maximum	50V AC (RMS)/DC

Material Info

Reference - Drawing Numbers

EU ELV

Not Relevant

EU RoHS

Compliant

REACH SVHC

Not Contained Per -
ED/30/2017 (7 July
2017)

Halogen-Free

Status

Not Low-Halogen

**Need more information on product
environmental compliance?**

Email productcompliance@molex.com
Please visit the [Contact Us](#) section for any
non-product compliance questions.

China ROHS

ELV

RoHS Phthalates

Green Image

Not Relevant

Not Contained

Search Parts in this Series

[501931](#) Series

Mates With

[503110](#) Crimp Housing

Application Specification
Packaging Specification
Product Specification
Sales Drawing

AS-503110-001-001, AS-503110-002-001
SPK-501931-001-001
PS-501931-002-001
SD-501931-001, SD-501931-002

This document was generated on 08/04/2017

PLEASE CHECK WWW.MOLEX.COM FOR LATEST PART INFORMATION