

**PLEASE CHECK WWW.MOLEX.COM FOR LATEST PART INFORMATION**

**Part Number:** [0512811294](#)  
**Status:** **Active**  
**Overview:** FFC-FPC (SMT)  
**Description:** 0.50mm Pitch FFC/FPC Connector, Surface Mount, Right Angle, Non-ZIF, Dual Contact Style, 1.20mm Mated Height, 12 Circuits, Gold (Au) Plating

**Documents:**

[3D Model](#) [Packaging Specification SPK-51281-001-001 \(PDF\)](#)  
[Drawing \(PDF\)](#) [RoHS Certificate of Compliance \(PDF\)](#)  
[Product Specification PS-51281-003-001 \(PDF\)](#)

**General**

Product Family FFC/FPC Connectors  
Series [51281](#)  
Overview [FFC-FPC \(SMT\)](#)  
Product Name Non-ZIF  
UPC 822348700042

**Physical**

Circuits (Loaded) 12  
Color - Resin Natural  
Contact Position Dual  
Durability (mating cycles max) 20  
Entry Angle 90° Angle  
Mated Height 1.20mm  
Material - Metal Phosphor Bronze  
Material - Plating Mating Gold  
Material - Plating Termination Tin  
Net Weight 80.536/mg  
Number of Rows 1  
Orientation Right Angle  
PCB Locator No  
PCB Retention Yes  
Packaging Type Embossed Tape on Reel  
Pitch - Mating Interface 0.50mm  
Plating min - Mating 0.102µm  
Plating min - Termination 1.016µm  
Polarized to PCB Yes  
Stackable No  
Surface Mount Compatible (SMC) N/A  
Temperature Range - Operating -20°C to +85°C  
Termination Interface: Style Surface Mount  
Wire/Cable Type FFC/FPC

**Electrical**

Current - Maximum per Contact 0.5A  
Voltage - Maximum 50V

**Material Info**

**Reference - Drawing Numbers**

Packaging Specification SPK-51281-001-001  
Product Specification PS-51281-003-001  
Sales Drawing SD-51281-011, SD-51281-012

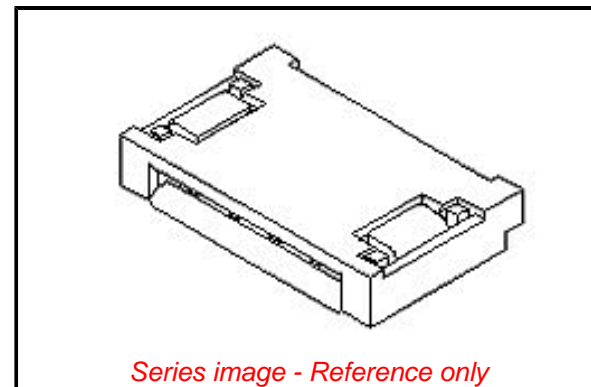

**EU ELV**

**Not Relevant**

**EU RoHS**

**Compliant**

**REACH SVHC**

Not Contained Per -  
ED/30/2017 (7 July  
2017)

**Halogen-Free**

**Status**

**Low-Halogen**

**Need more information on product environmental compliance?**

Email [productcompliance@molex.com](mailto:productcompliance@molex.com)  
Please visit the [Contact Us](#) section for any non-product compliance questions.

China ROHS

ELV

RoHS Phthalates

Green Image

Not Relevant

Not Contained

**Search Parts in this Series**

[51281 Series](#)

**PLEASE CHECK [WWW.MOLEX.COM](http://WWW.MOLEX.COM) FOR LATEST PART INFORMATION**