



Page 19-3

LEVEL CONTROL RELAYS

- For conductive liquids
- Single, dual or multivoltage
- Emptying or filling functions
- Multifunctions
- Automatic reset
- Modular and plug-in versions.



Page 19-6

PROBES, ELECTRODES AND ELECTRODE HOLDERS

- Single pole
- Three pole.



Page 19-7

FLOAT SWITCHES

- Versions for grey and dirty water
- Versions with PVC and Neoprene cable
- Emptying or filling functions.



Page 19-8

START-UP PRIORITY CHANGE RELAYS

- 2 outputs
- Single or multivoltage
- Modular and plug-in versions.



- Level monitoring for electrically conductive liquids
- Modular and plug-in versions
- Adjustable 2.5...200kΩ sensitivity
- Single and three-pole probes
- Float switches
- Start-up priority change relays.

	SEC. - PAGE
Level monitoring relays	
Modular version for conductive liquids	19 - 3
Plug-in version for conductive liquids	19 - 5
Probes, electrodes and electrode holders	19 - 6
Float switches	19 - 7
Start-up priority change relays	
Modular version	19 - 8
Plug-in version	19 - 8
Accessories	19 - 9
Dimensions	19 - 10
Wiring diagrams	19 - 11
Technical characteristics	19 - 14



Description	LEVEL CONTROL RELAYS					PRIORITY CHANGE RELAYS FOR 2 MOTORS			
	LVM20	LVM25	LVM30	LVM40	LV1E	LV2E	LVMP05	LVMP10	CSP2E
Modular version	●(2U)	●(1U)	●(3U)	●(3U)			●(1U)	●(3U)	
Plug-in version					● (8 pin)	● (11 pin)			● (11 pin)
3 detecting electrodes (MIN, MAX and COM)	●	●	●		●	●			
5 detecting electrodes (MIN1, MAX1, MIN2, MAX2 and COM)				●					
Sensitivity adjustment 2.5...50kΩ	●		●						
Sensitivity adjustment 2.5...100kΩ		●							
Sensitivity adjustment 2.5...200kΩ				●					
Fixed sensitivity: 7...8kΩ					●	●			
Adjustable sensitivity full-scale value 25-50-100-200 kΩ				●					
Separate sensitivity adjustment for MAX probe (foam detection)				●					
Emptying function and alarms	●	●	●	●	●	●			
Filling function and alarms		●	●	●					
Emptying function with Extra-MIN and/or Extra-MAX alarm relays				●					
Filling function with Extra-MIN and/or Extra-MAX alarm relays				●					
Emptying function with start change control				●					
Filling function with start change control				●					
Tank filling, well drawing functions and alarm				●					
Filling-emptying adjustment selector		●	●						
Programming selector for 5 different functions				●					
Motor start-up priority change							●		
Motor start-up priority change with stand-by motor function								●	●
Page	19-3			19-4	19-5		19-8		



Some permitted liquid substances				Liquid substances not permitted
Type of liquid	Resistivity kΩcm	Type of liquid	Resistivity kΩcm	<ul style="list-style-type: none"> • Purified water • Deionised water • Petrol • Oil • Liquid gases • Paraffin • Ethylene glycol • Paints • Liquids with a high percentage of alcohol
Drinking water	5-10	Milk	~1	
Well water	2-5	Whey	~1	
River water	2-15	Fruit juices	~1	
Rainwater	15-25	Vegetable juices	~1	
Sludge	0.5-2	Soups	~1	
Seawater	~0.03	Wine	~2.2	
Salt water	~2.2	Beer	~2.2	
Natural/hard water	~5	Coffee	~2.2	
Chlorinated water	~5	Suds	~18	
Condensed water	~18			

N.B. The resistivity values in the table are purely indicative.

Single-voltage relay



LVM20...

Order code	Auxiliary supply voltage	Type of output contact	Qty per pack	Wt
	[V] 50/60Hz	$\frac{C}{O}$	n°	[kg]
Emptying function. Automatic reset.				
LVM20 A024	24VAC	1 C/O (SPDT)	1	0.215
LVM20 A127	110...127VAC	1 C/O (SPDT)	1	0.215
LVM20 A240	220...240VAC	1 C/O (SPDT)	1	0.215
LVM20 A415	380...415VAC	1 C/O (SPDT)	1	0.215

Operational characteristics

- Used with 3 sensing electrodes, MIN, MAX and COM
- 2.5...50k Ω adjustable sensitivity
- Double insulation between each supply, electrodes and output relay circuits
- Fixed probe signal delay: <1s
- Green LED indicator for power on
- Red LED indicator for output relay state
- Modular DIN 43880 housing (2 modules)
- IEC degree of protection: IP40 on front (only when mounted in housing or electric board with IP40); IP20 on terminals.

Certifications and compliance

Certifications obtained: EAC, UL Listed, for USA and Canada (cULus-File E93601), as Auxiliary Devices - Level control relays.
Compliant with standards: IEC/EN 60255-5, IEC/EN 61000-6-2, IEC/EN 61000-6-3, UL508, CSA C22.2 no. 14.

Probes, electrode holders and float switches

Use probes and electrode holders type: SN1/PS31/PS3S/SCM/CGL or similar (see page 19-6).
For the choice of float switches see page 19-7.

Multi-voltage relay



LVM25 240



LVMKIT25

Order code	Auxiliary supply voltage	Type of output contact	Qty per pack	Wt
	[V]	$\frac{C}{O}$	n°	[kg]
Emptying or filling functions. Automatic reset.				
LVM25 240	24...240VAC/DC	1 C/O (SPDT)	1	0.095

Order code	Description	Qty per pack	Wt
		n°	[kg]

Level control relay LVM25 240 and SN1 electrodes kit.

LVMKIT25	Level control relay LVM25 240 and 2 SN1 probes	1	0.192
----------	--	---	-------

Operational characteristics

- Used with 3 sensing electrodes, MIN, MAX and COM
- 2.5...100k Ω adjustable sensitivity
- Insensitivity to stray electrode-cable capacitance
- Programming selector for emptying or filling function with fail-safe operation
- Double insulation between each supply, electrodes and output relay circuits
- Fixed probe signal delay: <1s
- Green LED indicator for power on
- Red LED indicator for output relay state
- Modular DIN 43880 housing (1 module)
- IEC degree of protection: IP40 on front (only when mounted in housing or electric board with IP40); IP20 on terminals.

Certifications and compliance

Certifications obtained: EAC, UL Listed, for USA and Canada (cULus-File E93601), as Auxiliary Devices - Level control relays.
Compliant with standards: IEC/EN 60255-5, IEC/EN 61000-6-2, IEC/EN 61000-6-4, UL508, CSA C22.2 n° 14.

Probes, electrode holders and float switches

Use probes and electrode holders type: SN1/PS31/PS3S/SCM/CGL or similar (see page 19-6).
For the choice of float switches see page 19-7.

Dual-voltage relay



LVM30...

Order code	Auxiliary supply voltage	Type of output contact	Qty per pack	Wt
	[V] 50/60Hz	$\frac{C}{O}$	n°	[kg]
Emptying or filling functions. Automatic reset.				
LVM30 A240	24/220...240VAC	2 C/O (SPDT)	1	0.315
LVM30 A415	110...127VAC 380...415VAC	2 C/O (SPDT)	1	0.315

Operational characteristics

- Used with 3 sensing electrodes, MIN, MAX and COM
- 2.5...50k Ω adjustable sensitivity
- Programming selector for emptying or filling function with fail-safe operation
- Double insulation between each supply, electrodes and output relay circuits
- Adjustable probe signal delay: 1...10s or pump start delay: 0...300s
- Green LED indicator for power on
- Red LED indicator for output relay state
- Modular DIN 43880 housing (3 modules)
- IEC degree of protection: IP40 on front (only when mounted in housing or electric board with IP40); IP20 on terminals.

Certifications and compliance

Certifications obtained: EAC, UL Listed, for USA and Canada (cULus-File E93601), as Auxiliary Devices - Level control relays.
Compliant with standards: IEC/EN 60255-5, IEC/EN 61000-6-2, IEC/EN 61000-6-3, UL508, CSA C22.2 n° 14.

Probes, electrode holders and float switches

Use probes and electrode holders type: SN1/PS31/PS3S/SCM/CGL or similar (see page 19-6).
For the choice of float switches see page 19-7.

Single-voltage multifunction relay



LVM40...

Order code	Auxiliary supply voltage	Type of output contacts	Qty per pack	Weight
	[V] 50/60Hz	1	n°	[kg]

Emptying or filling functions.
Multifunctions.
Automatic reset.

LVM40 A024	24VAC	1+1NO	1	0.278
LVM40 A127	110...127VAC	1+1NO	1	0.278
LVM40 A240	220...240VAC	1+1NO	1	0.278
LVM40 A415	380...415VAC	1+1NO	1	0.278

1 Two relay outputs; one with c/o (SPDT) and the other with N/O (SPST).

FUNCTIONS

A- Emptying with MIN and/or MAX alarms.

B- Filling with MIN and/or MAX alarms.

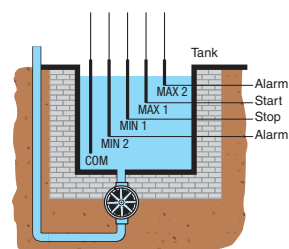

EXAMPLE OF EMPTYING OPERATION

To achieve this type of operation, two electrodes are used to control the liquid between the fixed limits using MIN1 and MAX1 and two alarm levels using MIN2 and MAX2. When one of the alarm electrodes is wet, the alarm relay is de-energised.

The alarm can be caused by pump malfunction, insufficient pump delivery capacity, MAX control level failure or MIN level electrode shorted.

With a proper connection, only the MIN alarm or MAX alarm can be activated or neither of the two can be activated so the relative output contacts can be used for pump control.

C- Emptying with pump priority change.

D- Filling with pump priority change.

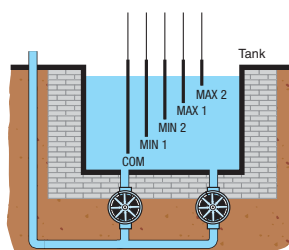

EXAMPLE OF EMPTYING OPERATION

This operation is obtained by using four electrodes positioned at four different levels and two relay outputs to control two pumps. For example, one can place the four electrodes, MIN1, MIN2, MAX1 and MAX2, in increasing order from the lowest to the highest levels and must control the tank emptying. Usually the level is controlled between the MIN1 and MAX1 levels by starting one of the two pumps. This case is different so the pumps can be maintained at the best efficiency and optimise their wear. When the liquid wets the MAX2 level and because the first pump is faulty or else a higher delivery capacity is needed, the second stand-by pump is activated to back up the first pump. When the liquid lowers and no longer wets the MIN2 level, the second pump is stopped and then when the MIN1 level is no longer wet, the first pump is stopped too.

E- Tank filling and well drawing with alarm.

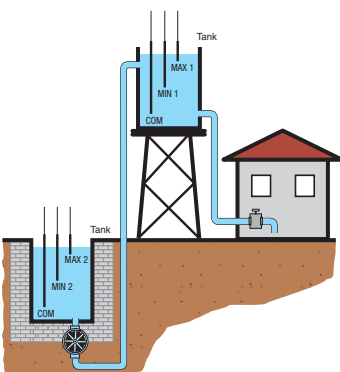

EXAMPLE.

Two electrodes are used in this operation to control the tank level and another two for the well. One relay is used to activate the pump while the other for dry running / no water alarm.

When the well liquid wets the MAX2 level and the liquid wets the MIN1 tank level, the tank-filling pump is activated.

When the tank MAX1 level is wet, the pump is stopped. During the tank filling, the pump could stop before the MAX1 level is wet because the well MIN2 level is no longer wet.

Should the tank MIN1 level no longer be wet at which the pump should restart but the well MIN2 level is also no longer wet, then the alarm relay is de-energised.

Operational characteristics

- Use with 5 sensing electrodes, MIN1, MAX1, MIN2, MAX2 and COM
- 2.5...200kΩ adjustable sensitivity
- Adjustable sensitivity full-scale value: 25-50-100-200kΩ
- Separate sensitivity adjustment of MAX electrodes for foam detection
- Insensitivity to stray electrode-cable capacitance
- Programming selector for 5 different functions:
 - emptying function and alarms (pos. A)
 - filling function and alarms (pos. B)
 - emptying function with priority start-up change control (pos. C)
 - filling function with priority start-up change pump (pos. D)
 - well draining and tank filling and alarms (pos. E)
- Double insulation between each supply, electrodes and output relay circuits
- Adjustable probe signal delay: 1...10s
- Adjustable pump start delay: 0...30min
- Green LED indicator for power on
- Red LED indicators for output relay and electrode state
- Modular DIN 43880 housing (3 modules)
- IEC degree of protection: IP40 on front (only when mounted in housing or electric board with IP40); IP20 on terminals.

Certifications and compliance

Certifications obtained: EAC, UL Listed, for USA and Canada (cULus-File E93601), as Auxiliary Devices - Level control relays.

Compliant with standards: IEC/EN 60255-5, IEC/EN 61000-6-2, IEC/EN 61000-6-3, UL508, CSA C22.2 n° 14.

Probes, electrode holders and float switches

Use probes and electrode holders type:

SN1/PS31/PS3S/SCM/CGL or similar (see page 19-6).

For the choice of float switches see page 19-7.

Single-voltage relay



31 LV1E...

Order code	Auxiliary supply voltage	Type of output contact	Qty per pack	Wt
	[V] 50/60Hz	$\frac{1}{1}$	n°	[kg]

Emptying or filling functions.
Automatic reset.

31 LV1E 24	24VAC	1 C/O (SPDT)	1	0.263
31 LV1E 110	110...120VAC	1 C/O (SPDT)	1	0.263
31 LV1E 230	220...240VAC	1 C/O (SPDT)	1	0.263
31 LV1E 400	380...415VAC	1 C/O (SPDT)	1	0.263

Operational characteristics

- Used with 3 sensing electrodes, MIN, MAX and COM
- 7...8k Ω fixed sensitivity
- Red LED indicator for output relay state
- Max. relay-electrode cable length: 500m/547yd single-core, double insulated cables
- Mounting on 35mm (IEC/EN 60715) DIN rail or 8-pin plug-in housing
- 8-pin plug-in housing (socket S8 or L48 P8 with G216; see page 19-9)
- IEC degree of protection: IP30.

Certifications and compliance

Certifications obtained: EAC.
Compliant with standards: IEC/EN 60255-5.

Probes, electrode holders and float switches

Use probes and electrode holders type: SN1/PS31/PS3S/SCM/CGL or similar (see page 19-6).
For the choice of float switches see page 19-7.

Dual-voltage relay



31 LV2E...

Order code	Auxiliary supply voltage	Type of output contact	Qty per pack	Wt
	[V] 50/60Hz	$\frac{1}{1}$	n°	[kg]

Emptying or filling functions.
Automatic reset.

31 LV2E 48	24/48VAC	1 C/O (SPDT)	1	0.266
31 LV2E 220	110...120VAC/ 220...240VAC	1 C/O (SPDT)	1	0.266
31 LV2E 400	220...240VAC/ 380...415VAC	1 C/O (SPDT)	1	0.266

Operational characteristics

- Used with 3 sensing electrodes, MIN, MAX and COM
- 7...8k Ω fixed sensitivity
- Red LED indicator for output relay state
- Max. relay-electrode cable length: 500m/547yd single-core, double insulated cables
- Mounting on 35mm (IEC/EN 60715) DIN rail or 11-pin plug-in housing
- 11-pin plug-in housing (socket S11 or L48 P11 with G216; see page 19-9)
- IEC degree of protection: IP30.

Certifications and compliance

Certifications obtained: EAC.
Compliant with standards: IEC/EN 60255-5.

Probes, electrode holders and float switches

Use probes and electrode holders type: SN1/PS31/PS3S/SCM/CGL or similar (see page 19-6).
For the choice of float switches see page 19-7.

Probes and electrode holders



11 SN1



31 SCM...



31 CGL125...



31 PS31



31 PS3S

Order code	Probe included	Probe length	Qty per pack	Weight
		[mm/in]	n°	[kg]

Single pole electrodes.

11 SN1	yes	1000/39.9"	10	0.050
--------	-----	------------	----	-------

31 SCM 04	yes	43/1.7"	1	0.060
-----------	-----	---------	---	-------

31 SCM 50	yes	500/19.7"	1	0.115
-----------	-----	-----------	---	-------

31 SCM 100	yes	1000/39.4"	1	0.162
------------	-----	------------	---	-------

31 CGL125 3	yes	327/12.9"	1	0.126
-------------	-----	-----------	---	-------

31 CGL125 5	yes	500/19.7"	1	0.158
-------------	-----	-----------	---	-------

31 CGL125 7	yes	700/27.6"	1	0.208
-------------	-----	-----------	---	-------

31 CGL125 10	yes	1000/39.4"	1	0.281
--------------	-----	------------	---	-------

Three pole electrode.

31 PS31	yes	300/11.8"	1	0.120
---------	-----	-----------	---	-------

Electrode holder (for 3 rod probes).

31 PS3S	no	—	1	0.184
---------	----	---	---	-------

① Total electrode length.

General characteristics

SN1 SINGLE POLE PROBES

A single pole probe used for level control in wells or storage tanks. It comprises of an AISI 303 stainless steel electrode, a plastic (PPOX) holder and a cable gland.

A seal ring and the tightening of the cable gland PG7 prevent water from entering the cable terminal connector and causing its oxidation.

Cable connection: screw.

The external cable diameter must be 2.5 to 6mm/Ø0.1 to 0.24" to warrant perfect sealing.

Maximum connection cable section: 2.5mm²

Maximum operating temperature: +60°C.

Application: Tanks and deep wells.

SCM... PROBES

A single pole probe used for level control on boilers, autoclaves and in general where pressure (10 bar maximum) and high temperature (+100°C maximum) are present. It comprises of an AISI 303 stainless steel electrode embedded in an aluminium oxide body and a 3/8" GAS threaded metal support holder.

Cable connection: Threaded rod with nut.

Application: Tanks, pressurised tanks and boilers.

CGL125... PROBES

A single pole probe with AISI 302 electrode, used for level control on boilers and autoclaves and in general wherever pressure is up to 10 bar maximum.

Maximum operating temperature: +180°C.

Threaded coupling: 3/8" GAS.

Cable connection: Threaded rod with nut.

Application: Tanks, pressurised tanks and boilers.

PS31 PROBE

A small electrode holder, complete with three AISI 304 stainless steel probes.

Particularly suited to small containers whenever pressure is maximum up to 2 bar.

Maximum operating temperature: +70°C.

Threaded coupling: 1/2" GAS.

Faston termination; related lugs supplied.

Application: Tanks and automatic dispensers.

PS3S ELECTRODE HOLDER

A thermoset resin electrode holder to be used with three probes (rods probes to be ordered separately) and complete with terminal cover.

Maximum operating temperature: +100°C.

2" GAS threaded coupling.

Cable connection: screw.

Application: tanks.

Certification and compliance

Certification obtained: EAC.

Compliant with standards: IEC/EN 60255-5.

Electrodes



31 ASTA...

Order code	Rod probe length	Qty per pack	Weight
	[mm/in]	n°	[kg]

For SCM probes.

31 ASTA 460 MM4	460/18.11"	1	0.053
-----------------	------------	---	-------

31 ASTA 960 MM4	960/37.8"	1	0.103
-----------------	-----------	---	-------

For PS3S electrode holder.

31 ASTA 460 MM6	460/18.11"	1	0.100
-----------------	------------	---	-------

31 ASTA 960 MM6	960/37.8"	1	0.210
-----------------	-----------	---	-------

General characteristics

Stainless steel AISI 304 electrodes with 4M or 6M threaded extremity suitable as extensions for SCM probe or as rod probe for PS3S electrode holder.

For connecting SCM probes with electrode extension unit (ASTA...MM4), see page 19-9.

Certification

Certification obtained: EAC.

For grey water



Order code	Cable material	Cable length	Counter-weight included	Qty	Wt
		[m]		n°	[kg]
LVFS P1 W 03	PVC	3	Yes	1	0.610
LVFS P1 W 05	PVC	5	Yes	1	0.830
LVFS P1 W 10	PVC	10	Yes	1	1.410
LVFS P1 W 15	PVC	15	Yes	1	1.930
LVFS N1 W 05	Neoprene	5	Yes	1	0.880
LVFS N1 W 10	Neoprene	10	Yes	1	1.510
LVFS N1 W 15	Neoprene	15	Yes	1	2.080
LVFS N1 W 20	Neoprene	20	Yes	1	2.480

Filling function

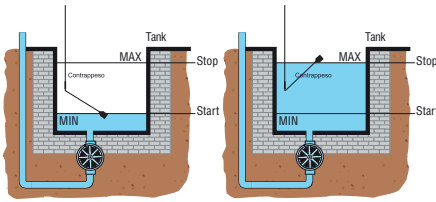

This function is achieved by connecting the black and blue float terminals. The level regulator contact closes the lower circuit at minimum level and opens the circuit when the float reaches the upper maximum level. The MIN and MAX levels can be adjusted by varying the distance between counterweight and float.

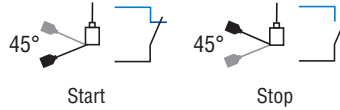

Emptying function

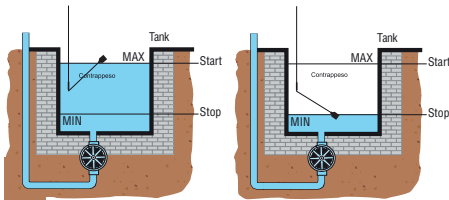

This function is achieved by connecting the black and brown float terminals. The level regulator contact closes the upper circuit at maximum level and opens the circuit when the float reaches the lower minimum level. The MIN and MAX levels can be adjusted by varying the distance between counterweight and float.

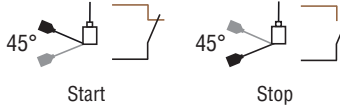

General characteristics

Float switches are used in the automation of electrical equipment, such as: pumps, solenoid valves, alarms, motorised sluice gates, etc. All versions feature an internal changeover contact operated in accordance with the level of liquid where the float is located. The cables used are high-quality and offer excellent mechanical and chemical resistance over time.

The cables are 3x1 type, that is 3 wires with section 1mm². This allows the user to choose the filling and emptying function during regulator wiring.

Operational characteristics

They are used for the civil and industrial control of levels of grey water, e.g. rainwater, groundwater or cooling water from industry. They are available with PVC and neoprene cables of various lengths.

- Activation angle -45°...+45°
- 130g external counterweight included
- Float casing material: polypropylene
- Cable A05 VV-F3X1 (PVC) available in lengths of 3, 5, 10 and 15m and cable H07 RN-F3X1 (Neoprene) available in lengths of 5, 10, 15 and 20m
- Rated cable diameter: 9mm (PVC and Neoprene)
- Relay with changeover contact 10(8)A 250VAC 50/60Hz
- Maximum installation depth: 30m
- Maximum pressure: 3bar
- Operating temperature: 0...+50°C
- Storage temperature: -20...+70°C
- IEC degree of protection: IP68
- Insulation class: II.

Certifications and compliance

Certifications obtained: TÜV.
Compliant with standards: IEC/EN 60730-1, IEC/EN 60730-2-15.

For dirty water



Order code	Cable material	Cable length	Counter-weight	Qty	Wt
		[m]		n°	[kg]
LVFS N1 B 05	Neoprene	5	Internal	1	1.250
LVFS N1 B 10	Neoprene	10	Internal	1	1.860
LVFS N1 B 15	Neoprene	15	Internal	1	2.460
LVFS N1 B 20	Neoprene	20	Internal	1	3.060

Filling function

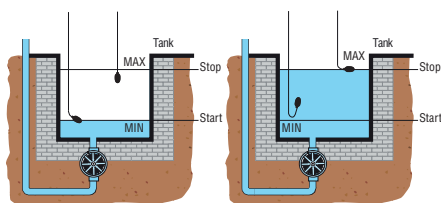

This function uses two floats and is achieved by connecting the black and blue float terminals. The MIN and MAX levels can be adjusted by varying the position of the floats.

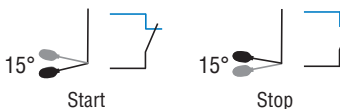

Emptying function

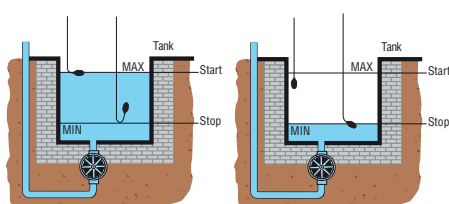

This function uses two floats and is achieved by connecting the black and brown float terminals. The MIN and MAX levels can be adjusted by varying the position of the floats.

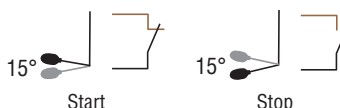

Operational characteristics

These float switches are used for the civil and industrial control of levels of dirty water, e.g. sewage or waste water from industry. The float switches comprises of a one-piece external blow-moulded polypropylene casing, with fixed internal counterweight located in the cable exit area.

The regulator contact is positioned centrally in its own watertight chamber. This is insulated from the external casing by injecting closed-cell foam. This solution further increases protection against moisture leakage and heat insulates the watertight chamber housing the contact, eliminating the creation of condensation.

- Activation angle -15°...+15°
- Internal counterweight
- Float casing material: polypropylene
- Cable H07 RN-F3X1 (Neoprene) available in lengths of 5, 10, 15 and 20m
- Rated cable diameter: 9mm
- Relay with changeover contact 10(4)A 250VAC 50/60Hz
- Maximum installation depth: 50m
- Maximum pressure: 5bar
- Operating temperature: 0...+50°C
- Storage temperature: -20...+70°C
- IEC degree of protection: IP68
- Insulation class: II.

Certifications and compliance

Certifications obtained: TÜV.
Compliant with standards: IEC/EN 60730-1, IEC/EN 60730-2-15.



It is possible to use even a single float for black water, adjusting the level in a fixed range of 10cm MAX, a solution which is not advisable for turbulent waters.

Modular version



LVMP05

Order code	Auxiliary supply voltage	Type of output contacts	Qty per pack	Weight
	[V]		n°	[kg]
2 outputs. AC and DC supply voltage.				
LVMP05	24/48VDC 24...240VAC	2N/O (SPST)	1	0.090

General characteristics

Priority change relays are designed to balance the operating time, and hence the wear of pumps, compressors, generators, when two units, primary and stand-by, are installed.

Operational characteristics

- Operating limits: 0.85...1.1 Ue
- Connection: permanent
- Green LED indicator for power on
- Red LED indicators for output relay state
- Modular DIN 43880 housing (1 module)
- IEC degree of protection: IP40 on front (only when mounted in housing or electric board with IP40); IP20 on terminals.

Certifications and compliance

Certifications obtained: EAC, UL Listed, for USA and Canada (cULus-File E93601), as Auxiliary Devices - Automatic starting control.

Compliant with standards: IEC/EN 60255-5, IEC/EN 61000-6-2, IEC/EN 61000-6-3, UL508, CSA C22.2 n° 14.



LVMP10...

Order code	Auxiliary supply voltage	Type of output contacts	Qty per pack	Weight
	[V] 50/60Hz		n°	[kg]
2 outputs. AC supply voltage.				
LVMP10 A024	24VAC	2 NO (SPST)	1	0.250
LVMP10 A127	110...127VAC	2 NO (SPST)	1	0.250
LVMP10 A240	220...240VAC	2 NO (SPST)	1	0.250
LVMP10 A415	380...415VAC	2 NO (SPST)	1	0.250

General characteristics

Priority change relays are designed to balance the operating time, and hence the wear of pumps, compressors, generators, when two units, primary and stand-by, are installed.

Operational characteristics

- Operating limits: 0.85...1.1 Ue
- Connection: permanent
- Green LED indicator for power on
- Red LED indicators for output relay state
- Modular DIN 43880 housing (3 modules)
- IEC degree of protection: IP40 on front (only when mounted in housing or electric board with IP40); IP20 on terminals.

Certifications and compliance

Certifications obtained: EAC, UL Listed, for USA and Canada (cULus-File E93601), as Auxiliary Devices - Automatic starting control.

Compliant with standards: IEC/EN 60255-5, IEC/EN 61000-6-2, IEC/EN 61000-6-3, UL508, CSA C22.2 n° 14.

Plug-in version



31 CSP2E...

Order code	Auxiliary supply voltage	Type of output contacts	Qty per pack	Weight
	[V] 50/60Hz		n°	[kg]
2 outputs. AC supply voltage.				
31 CSP2E 24	24VAC	2 NO (SPST)	1	0.150
31 CSP2E 110	110VAC	2 NO (SPST)	1	0.150
31 CSP2E 220	220VAC	2 NO (SPST)	1	0.150
31 CSP2E 230	230...240VAC	2 NO (SPST)	1	0.150

General characteristics

Priority change relays are designed to balance the operating time, and hence the wear of pumps, compressors, generators, when two units, primary and stand-by, are installed.

Operational characteristics

- Operating limits: 0.85...1.1 Ue
- Connection: permanent
- Voltage applied to input contacts: 15VDC not insulated at power supply.
- Current consumption, input contacts: about 1mA.
- 11-pin plug-in housing (sockets S11 or L48 P11 with 31 G216; see page 19-9).
- IEC degree of protection: IP30.

Certifications and compliance

Certifications obtained: EAC.
Compliant with standards: IEC/EN 60255-5.

Accessories



31 RE213



31 S8



31 S11

Order code	Description	Qty per pack	Weight
		n°	[kg]
31 RE213	Coupler unit for SCM with electrode extension ASTA...MM4	1	0.008
31 S8	8-pin socket for screw fixing or mounting on 35mm DIN rail (IEC/EN 60715), used with LV1E... relay. Screw terminals.	10	0.061
31 S11	11-pin socket for screw fixing or mounting on 35mm DIN rail (IEC/EN 60715), used with LV2E... and CSP2E... relays. Screw terminals.	10	0.064
31 RE014	Relay-socket retention bracket; S8 or S11 types only.	10	0.001
31 L48 P8	8-pin loose socket. Screw terminals	10	0.040
31 L48P11	11-pin socket, loose. Screw terminals	10	0.048
31 G216	Kit for flush mounting socketed relays	1	0.080

Operational characteristics

SOCKETS FOR INSTALLING PLUG-IN LEVEL CONTROL RELAYS.

- max. wire section for sockets: 2x2.5mm²/2x14AWG
- tightening torque: 0.8Nm/7.1lbin.

Certifications and compliance

Certifications obtained: EAC.
Compliant with standards: IEC/EN 61984, IEC/EN 61210, IEC/EN 60999-1.

LEVEL CONTROL AND START-UP PRIORITY CHANGE RELAYS

LVM25... - LVMP05

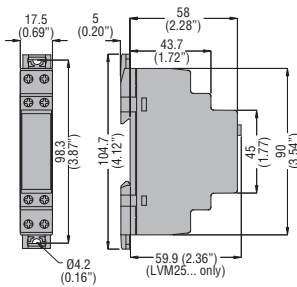

LVM20...

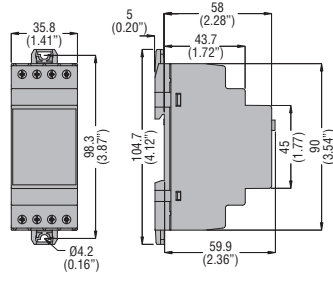

LVM30... - LVM40... - LVMP10

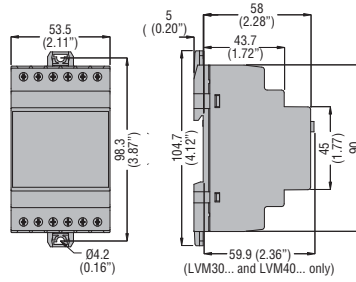

LV1E... - LV2E... - CSP2E...

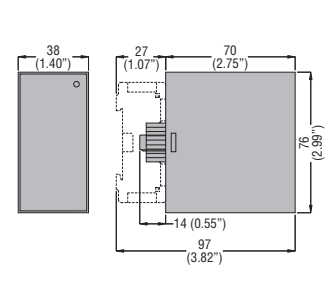

PROBES AND ELECTRODE HOLDERS FOR CONDUCTIVE LIQUIDS

SN1

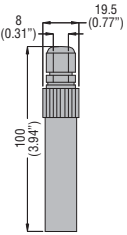

SCM...

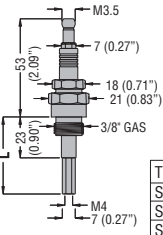

TYPE	L
SCM04	43 (1.69")
SCM50	500 (19.68")
SCM100	1000 (39.37")

CGL125...

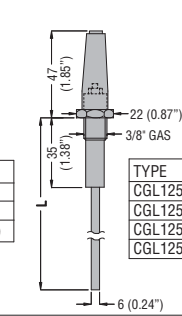

TYPE	L
CGL125 3	327 (12.87")
CGL125 5	500 (19.68")
CGL125 7	700 (27.56")
CGL125 10	1000 (39.37")

PS31

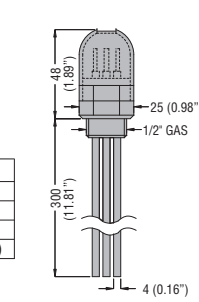

PS3S

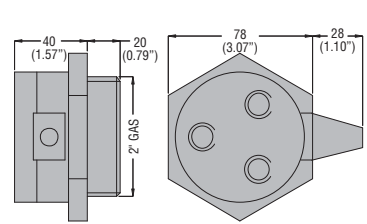

ELECTRODES

ASTA 460 MM4

ASTA 960 MM4

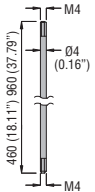

ASTA 460 MM6

ASTA 960 MM6

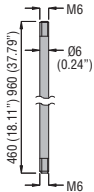

Coupler unit

RE213

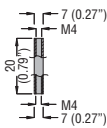

FLOAT SWITCHES

LVFS...W...

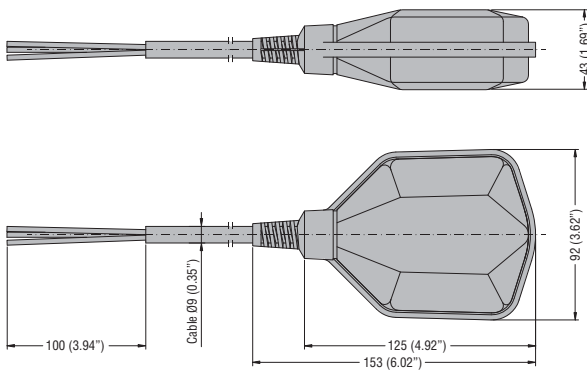

LVFS N1 B...

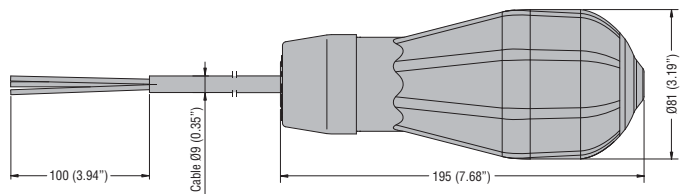

ACCESSORIES

S8 - S11

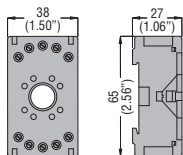

L48 P8

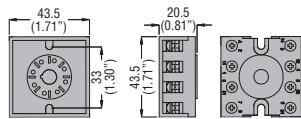

L48 P11

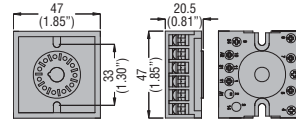

RE014

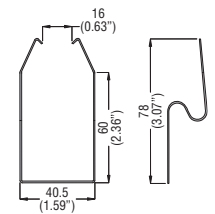

G216

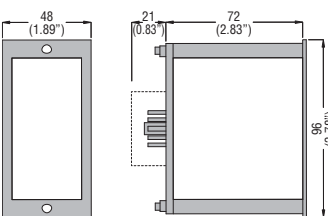

Cutout

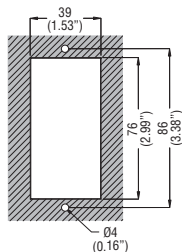

Emptying function

LVM20

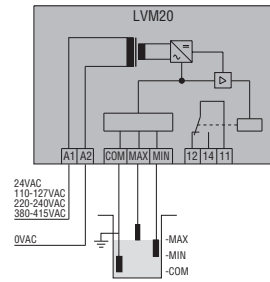

Emptying function with 3 electrodes

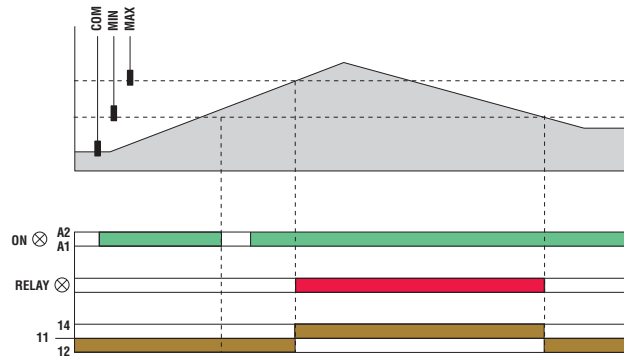

Emptying function with 2 electrodes

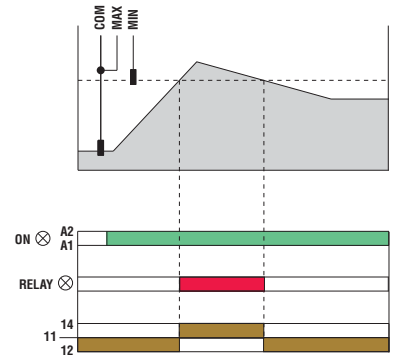

Emptying or filling functions

LVM25

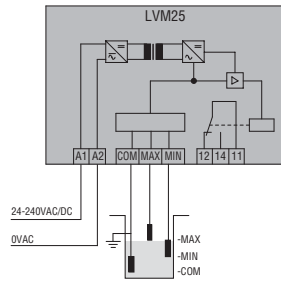

Emptying function (DOWN) Connection with 3 electrodes

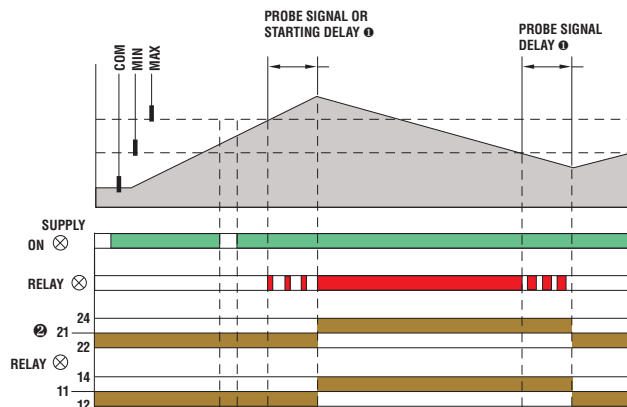

Connection with 2 electrodes

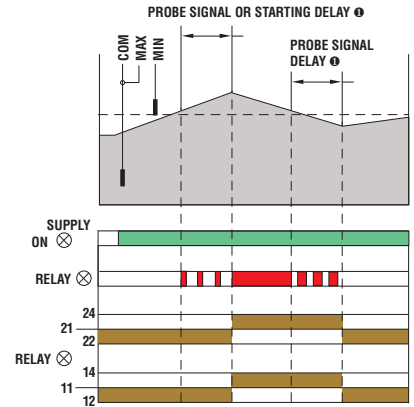

LVM30

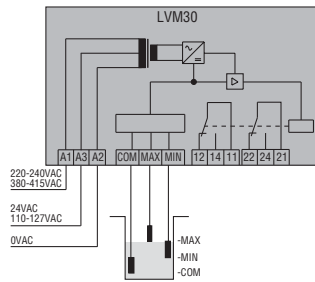

Filling function (UP) Connection with 3 electrodes

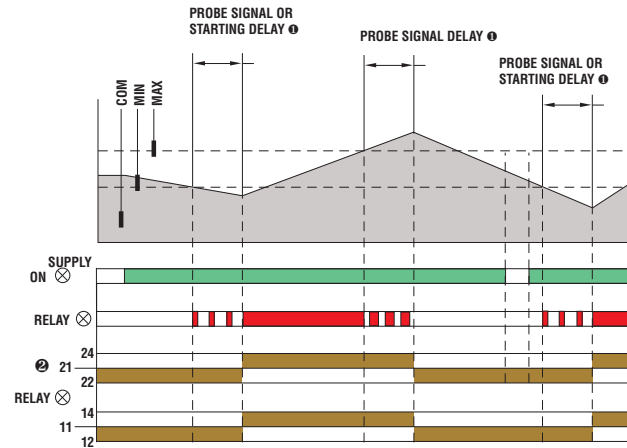

Connection with 2 electrodes

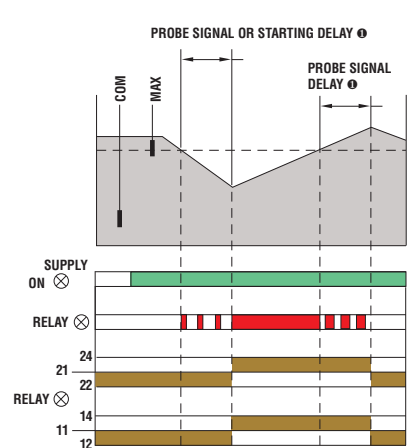

- ① Delay for LVM30 only.
- ② Changeover contact (SPDT) for LVM30 only.

Multifunctions.
LVM40

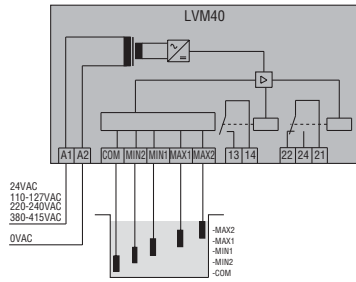

Emptying function + alarms

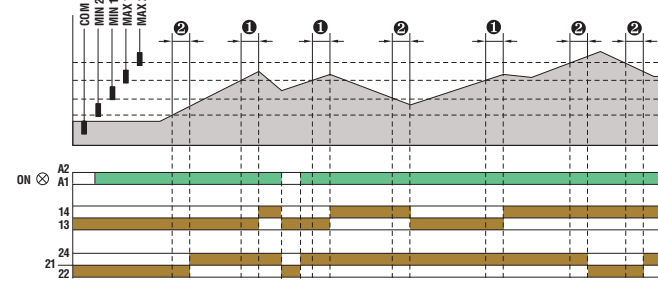

Filling function + alarms

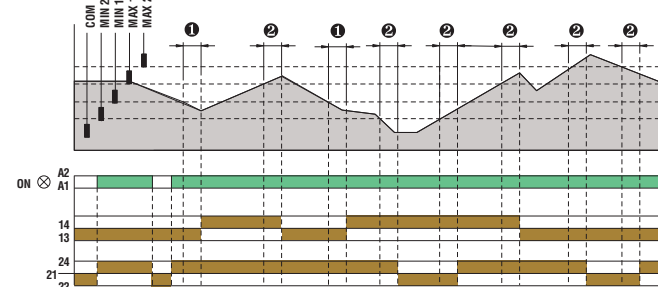

Emptying function + pump start change

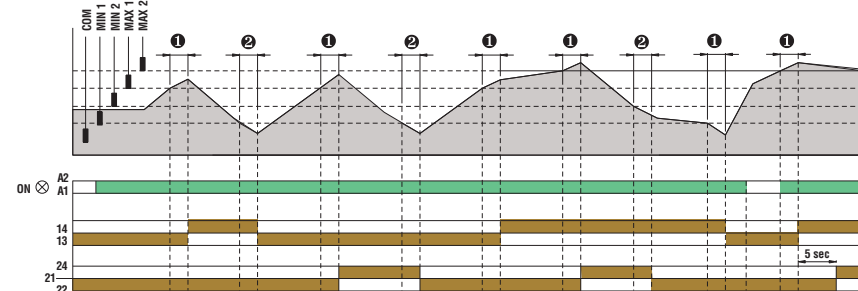

Filling function + pump start change

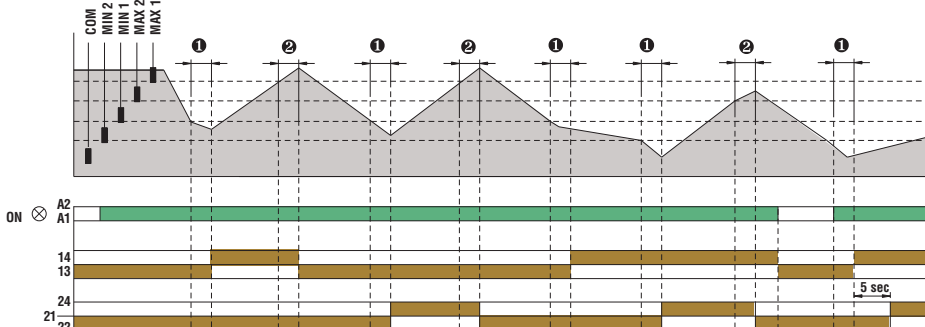

Filling tank and draining well function + alarm

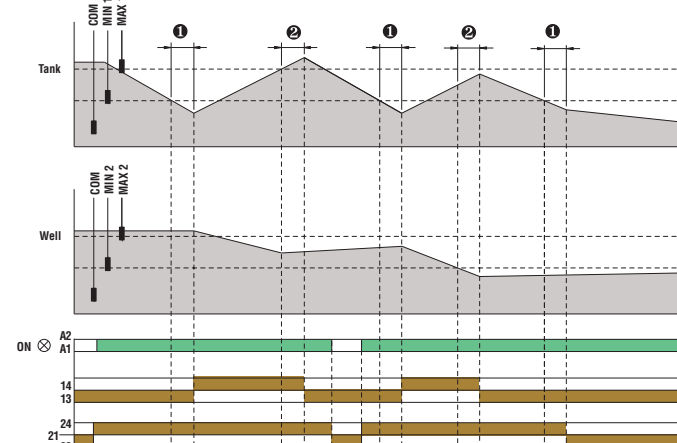

- 1 Probe signal + starting delay.
- 2 Probe signal delay.

Emptying function

LV1E

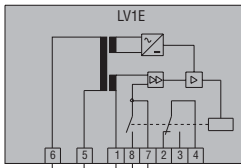

24VAC
110-120VAC
220-240VAC
380-415VAC
0VAC

LV2E

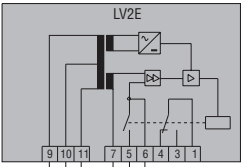

48VAC
220-240VAC
380-415VAC
24VAC
110-120VAC
220-240VAC
0VAC

Emptying function with 3 electrodes

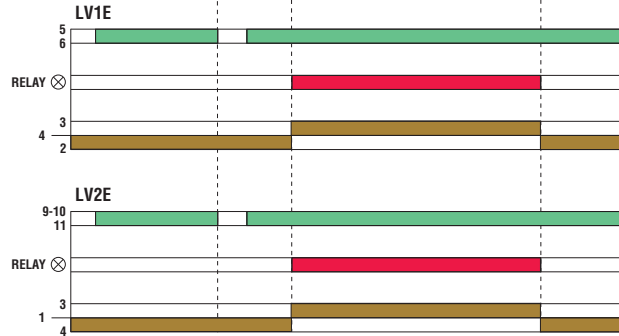
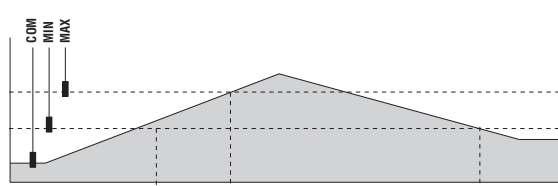

Emptying function with 2 electrodes

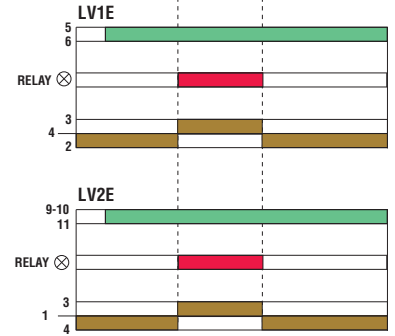
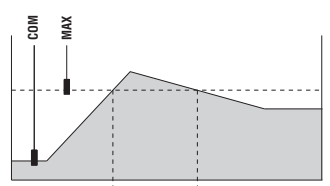

Priority change relays

LVMP05

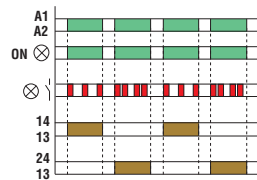
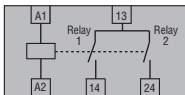

LVMP10

2-wire connection

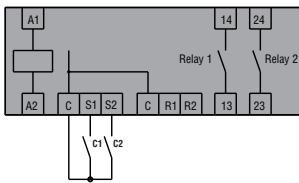

C1 = Primary
C2 = Secondary / Standby

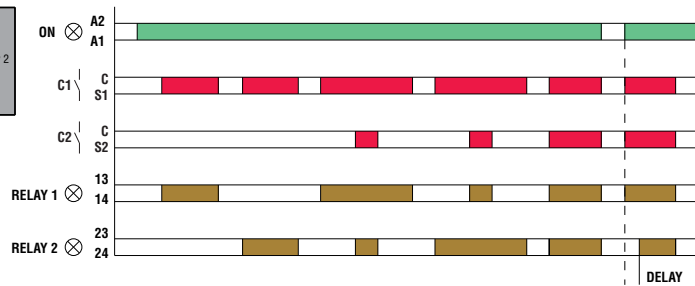

3-wire connection

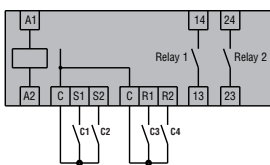

C1 = Start Primary
C2 = Start Standby
C3 = Stop Primary
C4 = Stop Standby

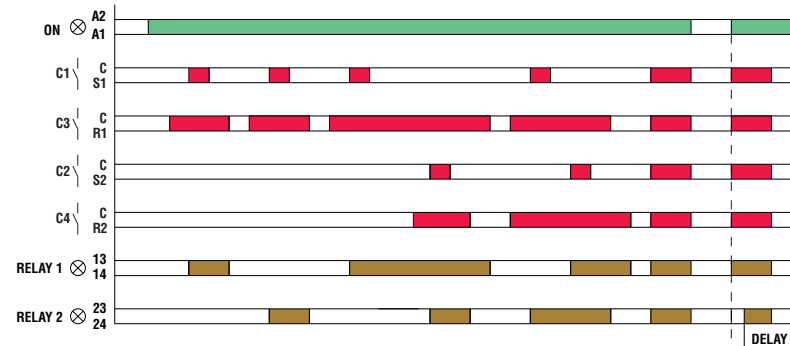

CSP2E

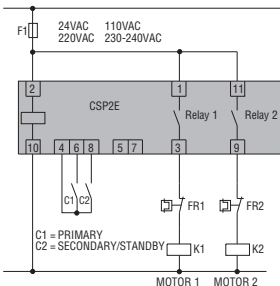

C1 = PRIMARY
C2 = SECONDARY/STANDBY

TYPE	LVM20...	LVM25...	LVM30...	LVM40...	
DESCRIPTION					
	Modular				
	Automatic reset				
	Single voltage	Multi voltage	Dual voltage	Single voltage	
Application (examples)	Emptying function	Emptying or filling function	Emptying or filling function	Multifunctions	
Operating principle	Electrical conductivity of liquids				
AUXILIARY SUPPLY					
Supply voltage Us	24VAC 110...127VAC 220...240VAC 380...415VAC	24...240VAC/DC	24/220...240VAC 110...127/380...415VAC	24VAC 110...127VAC 220...240VAC 380...415VAC	
Operating voltage range	0.85...1.1 Ue; 50/60Hz ±5%				
Power consumption (maximum)	3.5VA	3VA	5.5VA	4.5VA	
Power dissipation (maximum)	1.8W	1.2W	2.8W	2.8W	
OUTPUTS					
Number of connectable electrodes	3	3	3	5	
Type of electrode	Electrode and electrode holders: SN1 / SCM / CGL / PS31 / PS3S or similar				
Electrode voltage	7.5VAC	5VPP	7.5VAC	5VPP	
Sensitivity	2.5...50kΩ	2.5...100kΩ	2.5...50kΩ	2.5...200kΩ	
TIME DELAYS					
Tripping time (minimum)	≤600ms	≤1s	1s	1s	
Resetting time (minimum)	≤750ms	≤1s	1s	1s	
Probe tripping delay	—	—	OFF...10s	1...10s	
Relay energising delay	—	—	OFF...300s	0...30min	
RELAY OUTPUTS					
Number of relays	1	1	1	2	
Relay state	Normally de-energised, energises at tripping				
Contact arrangement	1 changeover / SPDT	1 changeover / SPDT	2 changeover / SPDT each	1 changeover / SPDT and 1 with 1 N/O - SPST	
Rated utilisation voltage	250VAC				
Maximum switching voltage	400VAC				
IEC conventional free air thermal current Ith	8A				
UL/CSA and IEC/EN 60947-5-1 designation	B300				
Electrical life (with rated load)	10 ⁶ cycles				
Mechanical life	30x10 ⁶ cycles				
Indications	1 green LED for power on 1 red LED for relay state	1 green LED for power on 1 red LED for relay state	1 green LED indicator for power on 1 red LED for relay state	green LED indicator for power on 2 red LEDs for relay state 2 red LEDs for probe state	
INSULATION					
IEC rated insulation voltage Ui	415VAC	240VAC	415VAC	415VAC	
IEC rated impulse withstand voltage Uimp	6kV	4kV	6kV	6kV	
IEC power frequency withstand voltage	4kV	2kV	4kV	4kV	
Double insulation Supply/relay/electrode	≤250VAC	≤250VAC ^①	≤250VAC	≤250VAC	
CONNECTIONS					
Tightening torque maximum	0.8Nm (7lbin; 7-9lbin er UL/CSA)				
Conductor section min-max	0.2-4mm ² (24-12AWG; 18-12 AWG per UL/CSA)				
AMBIENT CONDITIONS					
Operating temperature	-20...+60 °C				
Storage temperature	-30...+80 °C				
HOUSING					
Material	Self-extinguishing polyamide				
Typical configuration (examples)	LVM20 + n° 3 SN1 electrodes		LVM25 + n° 3 SN1 electrodes		LVM40 + n° 5 SN1 electrodes
Maximum cable length	②				

① Double insulation between supply, electrodes and output relay circuit.

② Voltage applied to input contacts, not insulated at power supply.

③ Consult Customer Service; see contact details on inside front cover.

LV1E...	LV2E...	LVMP 05	LVMP 10	CSP2E
Plug-in		Modular	Modular	Plug-in
Automatic resetting	Automatic resetting	—	—	—
Single voltage	Dual voltage	Multistage	Single voltage	Single voltage
– Minimum-maximum level threshold – Maintains level between minimum and maximum – Protection against dry pump running Electrical conductivity of liquids		Priority change relay for motors		
Electrical conductivity of liquids		—		
24VAC	24/48VAC	24...48VDC 24...240VAC	24VAC	24VAC
110...120VAC	110...120VAC/220...240VAC		110...127VAC	110VAC
220...240VAC	220...240VAC/380...415VAC		220...240VAC	230/240VAC
380...415VAC			380...415VAC	
0.8...1.1 Ue 50/60Hz				
5.5VA		1.6VA	4.8VA	5VA
2.8W		0.9W	3W	3W
3		—	—	—
Electrode and electrode holders: SN1 / SCM / CGL / PS31 / PS3S / or similar		—	—	—
9VAC (voltage between probes)		—	—	—
7...8 kΩ fixed		—	—	—
≤50ms		—	—	—
≤100ms		—	—	—
—		—	—	—
—		—	—	—
1		2	2	2
Normally de-energised, energises at tripping				
1 changeover contact / SPDT		1 N/O - SPST	1 N/O - SPST	1 N/O - SPST
220VAC		250VAC	250VAC	250VAC
380VAC		—	—	—
5A		8A	8A	5A
B300		B300	B300	B300
2.5x10 ⁵ cycles		10 ⁵ cycles	10 ⁵ cycles	10 ⁵ cycles
50x10 ⁶ cycles		30x10 ⁶ cycles	30x10 ⁶ cycles	30x10 ⁶ cycles
1 red LED for relay tripping		1 green LED for power on 1 red LED for relay state	1 green LED for power on 1 red LED for relay state	1 green LED for power on 1 red LED for relay state
415VAC		250VAC	415VAC	250VAC
5kV		4kV	4kV	4kV
2kV		2kV	2.5kV	2.5kV
—		—		
—		0.8Nm (7Ibin; 7-9Ibin er UL/CSA)		—
—		0.2-4.0mm ² (24-12AWG; 18-12 AWG per UL/CSA)		—
—		-20...+60°C		—
—		-30...+80°C		—
Self-extinguishing polycarbonate		Self-extinguishing polyamide	Self-extinguishing polyamide	Self-extinguishing polycarbonate
LV1E + n° 3 SN1 electrode		—	—	—
LV2E + n° 2 SN1 electrodes + reset button		—	—	—
500m/547yd single-core, double insulated cables		—	—	—

X-ON Electronics

Authorized Distributor

Click to view similar products for [Industrial Relays](#) category:

Click to view products by [Lovato](#) manufacturer:

Other Similar products are found below :

[ADXC012400](#) [HR201AS024](#) [HR201DS024](#) [LVM20A127](#) [31ASTA460MM4](#)

[ADXC025600R2](#) [ADXC032400](#) [31CGL12510](#) [31SCM04](#) [ADXL0030600](#) [LVM20A240](#)

[PMV55A240](#) [PMV50A575](#) [PMV40A575](#) [PMV30A575](#) [PMV20A240](#) [PMF20A240](#)

[LVMKIT25](#) [LVM30A240](#) [ADXL0085600](#) [ADXL0075600](#) [ADXL0045600](#) [31CGL1253](#)

[31ASTA960MM6](#) [11SN1](#) [ADXC045400](#) [ADXC037400](#) [ADXC02540024](#) [ADXC016400](#)

[ADXC025400](#) [RGKX23](#) [RGKX22](#) [RGKX21](#) [RGKX01](#) [RGKSW20](#) [LVM40A240](#)

[PMV70A575](#) [PMV20A575](#) [PMA50A240](#) [31RM415](#) [LVM25240](#)