

LD120-0CW-60D-LL

Extra Cool White

3mm, Dome, 5.1mm Height

57° viewing angle

DWG BY:
LL / GP
07-31-07

CHK BY:
PL
09-11-07

QA:

__-__-__

MFG:

__-__-__

REVISION LTR: -
09-10-07

Features:

- High intensity
- Normal 3mm diameter no flange package
- Tin plated copper leads
- Pb-free

Package Dimensions:

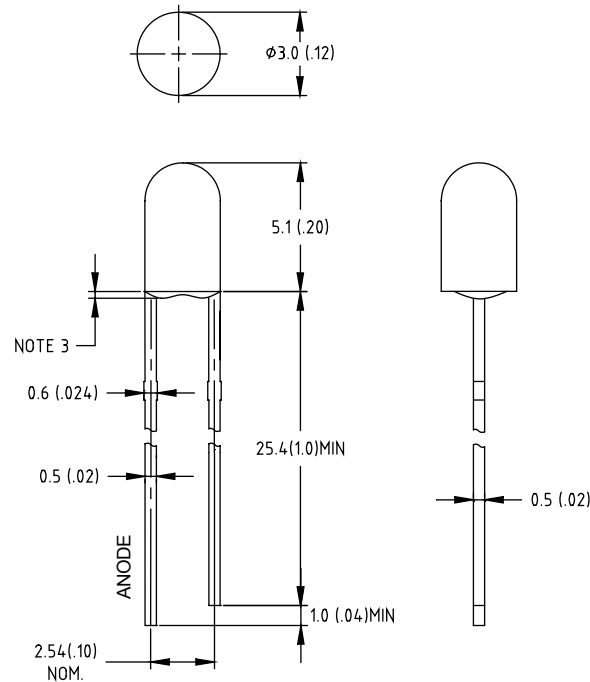

Part No.	Chip Material	Lens Color	Emission Color
LD120-0CW-60D-LL	InGaN	Water Clear	White

Notes:

1. All dimensions are in millimeters (inches).
2. Tolerance is ± 0.25 mm (.010") unless otherwise noted.
3. Protruded resin under flange is 1.0mm (.04") max.
4. Lead spacing is measured where the leads emerge from the package.
5. Specifications are subject to change without notice.
6. Precautions for ESD: Static electricity and surge can damage the LED. It is recommended to use a wristband or anti-electrostatic glove when handling the LED. All devices, equipment and machinery must be properly grounded.

Absolute Maximum Ratings at Ta=25°C

Parameter	MAX.	Unit
Power Dissipation	80	mW
Peak Forward Current (1/10 Duty Cycle, 0.1ms Pulse Width)	100	mA
Continuous Forward Current	20	mA
Derating Linear From 50°C	0.4	mA/°C
Reverse Voltage	5	V
Electrostatic Discharge (ESD)	600	V
Operating Temperature Range	-20°C to +80°C	
Storage Temperature Range	-30°C to +100°C	
Lead Soldering Temperature [4mm(.157") From Body]	280°C for 5 Seconds	

Electrical Optical Characteristics at Ta=25°C

Parameter	Symbol	Min.	Typ.	Max.	Unit	Test Condition
Luminous Intensity	I _V	---	3500	---	mcd	I _F =20mA (Note 1)
Viewing Angle	2θ _{1/2}	50	57	64	Deg	(Note 2)
Forward Voltage	V _F	---	3.2	3.8	V	I _F =20mA
Reverse Current	I _R	---	---	10	μA	V _R =5V
SCP	---	---	---	---	cd	I _F =20mA
Lumens	---	---	---	---	lm	I _F =20mA
Radiant Intensity	---	---	---	---	mW/sr	I _F =20mA
Color Rendering Index	CRI	79	---	83	---	---

Color Rank	x	y	x	y	x	y	x	y
LTC & LTD	0.270	0.285	0.288	0.250	0.305	0.275	0.295	0.325

Notes:

- Luminous intensity is measured with a light sensor and filter combination that approximates the CIE eye-response curve.
- θ_{1/2} is the off-axis angle at which the luminous intensity is half the axial luminous intensity.
- Forward voltage measurement allowance is ±0.1V
- Luminous Intensity Measurement Allowance is ± 10%.

Typical Electrical / Optical Characteristics Curves
 (25°C Ambient Temperature Unless Otherwise Noted)

CIE 1931 Chromaticity Diagram

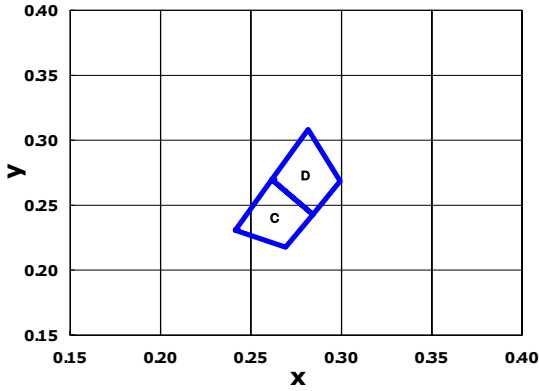

Spectral Radiance

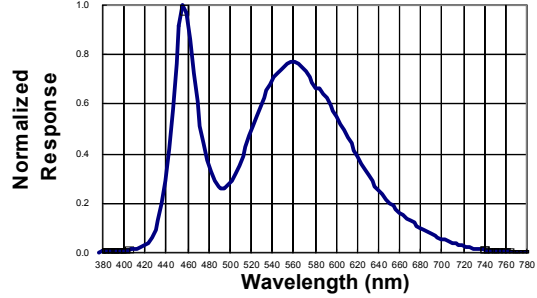

Relative Intensity vs Forward Current

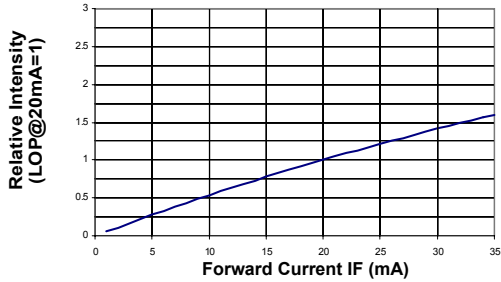

Forward Current vs Forward Voltage

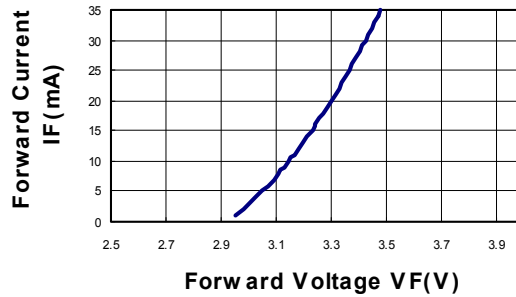

Forward Current vs. Chromaticity coordinate

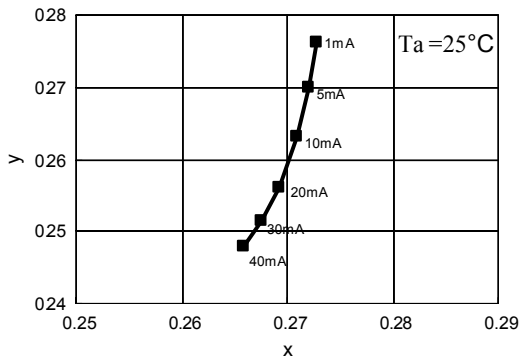

Forward Current Derating Curve

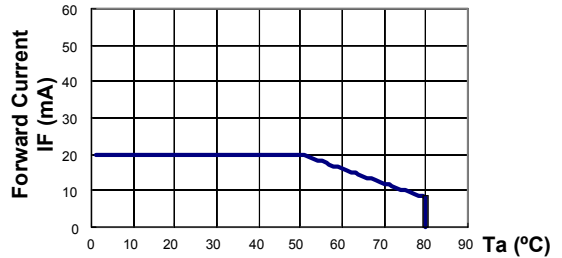

Beam Pattern

