

Product Data Sheet



ST 710 31

Studded Connection Block
300 Volts AC/DC



Wire Range:

Designed for two or more wire lugs

Electrical Ratings:

- 300 Volts AC/DC

Mechanical Ratings:

- Maximum insulator base temperature: 125°C (257°F) UL RTI
- Flammability rating of insulator base: UL 94 V-0
 - Use outside these ratings needs to be judged in the end-use application.

Materials:

- Studs: Stainless Steel
- Insulator base: Glass-filled polycarbonate (Thermoplastic)
- Hardware (Nuts and Washers): Stainless Steel

- RoHS Compliant

Application torque: 192 in-lbs.

- Clamping distance: 3/4"
- Panel mountable: #1/4" fastener, torque to 30-40 in. lbs.

ST 710 31 RED
RED insulator base
typically used for
terminations on the
POSITIVE circuits

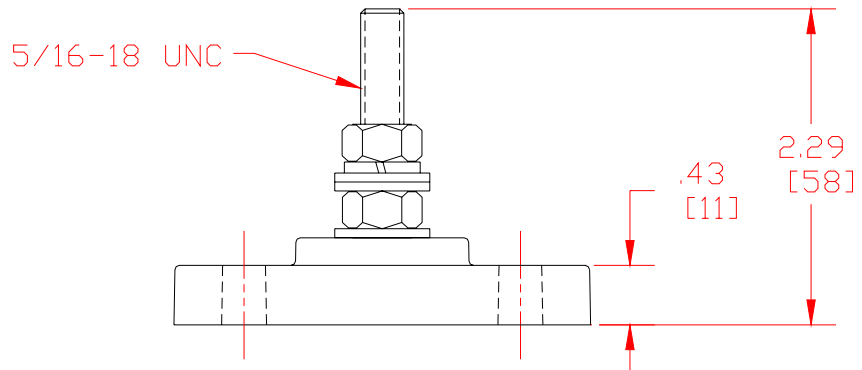
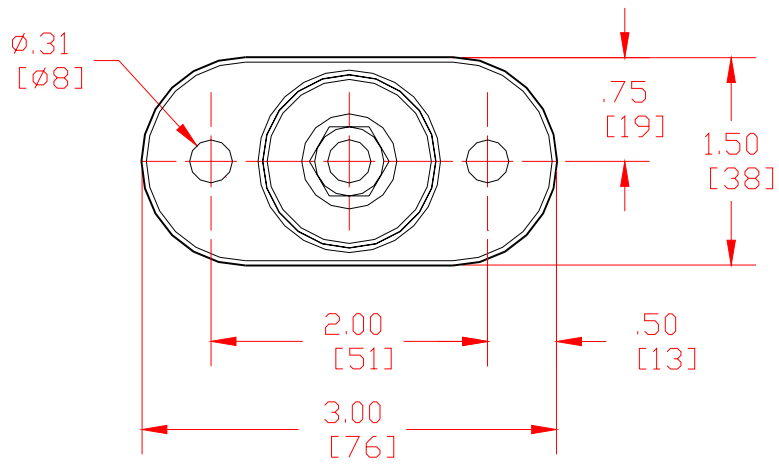

WWW.MARATHONSP.COM
1-419-352-8441