

Polypropylene Pulse/High Frequency Capacitors
**R73, Polypropylene Film/Foil, Radial
 (Automotive Grade)**

Overview

The R73 Series is constructed of polypropylene film and metal foil or metallized film and metal foil with radial leads of tinned wire. The radial leads are electrically welded to the metal layer on the ends of the capacitor winding. The capacitor is encapsulated in a self-extinguishing solvent resistant plastic case with thermosetting resin material meeting the UL 94 V-0 requirements. Two different winding constructions are used depending on voltage parameters. Please see the Performance Characteristics for more information.

Automotive grade devices (up to lead spacing 22.5 mm) meet the demanding Automotive Electronics Council's AEC-Q200 qualification requirements.

Applications

Typical applications include resonant circuit, high frequency high current, snubber and silicon-controlled rectifier (SCR and IGBT) and SiC (e.g. MOSFET) commutation circuits as well as applications with high voltage and high current. Not suitable for across-the-line application (see Suppressor Capacitors).

Benefits

- Voltage range: 100 – 2,000 VDC
- Capacitance range: 100 pF – 2.2 μF
- Lead Spacing: 15 – 37.5 mm
- Capacitance tolerance: ±2.5% (for 2-section construction only) ±5%, ±10%
- Climatic category: 55/105/56 IEC 60068-1
- Operating temperature range of -55°C to +105°C
- RoHS compliance and lead-free terminations
- Tape & Reel packaging in accordance with IEC 60286-2
- Self-healing
- Automotive (AEC-Q200) grade up to lead spacing 22.5 mm

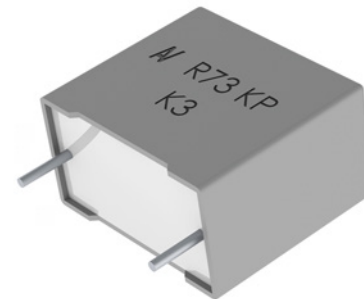

Part Number System

R73	E	I	2470	AA	00	H
Series	Rated Voltage (VDC)	Lead Spacing (mm)	Capacitance Code (pF)	Packaging	Internal Use	Capacitance Tolerance
Polypropylene Film/Foil	E = 100 G = 160 I = 250 M = 400 P = 630 Q = 1000 R = 1250 T = 1600 U = 2000	I = 15.0 N = 22.5 R = 27.5 W = 37.5	The last three digits represent significant figures. The first digit specifies the total number of zeros to be added.	See Ordering Options Table	00 10 30 40 L0	H = ±2.5% (for 2-section construction only) J = ±5% K = ±10%

Ordering Options Table

Lead Spacing Nominal (mm)	Type of Leads and Packaging	Lead Length (mm)	Lead and Packaging Code
15 22.5	Standard Lead and Packaging Options		
	Bulk (Bag) – Short Leads	4 +2/-0	SE
	Ammo Pack	H ₀ = 18.5 ±0.5	DQ
	Other Lead and Packaging Options		
	Tape & Reel (Standard Reel Ø 355 mm)	H ₀ = 18.5 ±0.5	GY
	Tape & Reel (Large Reel Ø 500 mm)	H ₀ = 18.5 ±0.5	CK
	Bulk (Bag) – Short Leads	3.5 +0.5/-0	JB
	Bulk (Bag) – Short Leads	4.0 +0.5/-0	JE
	Bulk (Bag) – Short Leads	3.2 +0.3/-0.2	JH
	Bulk (Bag) – Long Leads	18±1	JM
	Bulk (Bag) – Long Leads	30 +5/-0	40
Bulk (Bag) – Long Leads	25 +2/-1	50	
27.5	Standard Lead and Packaging Options		
	Bulk (Tray) – Short Leads	4 +2/-0	SE
	Other Lead and Packaging Options		
	Tape & Reel (Standard Reel Ø 355 mm)	H ₀ = 18.5 ±0.5	GY
	Tape & Reel (Large Reel Ø 500 mm)	H ₀ = 18.5 ±0.5	CK ¹
	Bulk (Tray) – Short Leads	3.5 +0.5/-0	JB
	Bulk (Tray) – Short Leads	4.0 +0.5/-0	JE
	Bulk (Tray) – Short Leads	3.2 +0.3/-0.2	JH
	Bulk (Tray) – Long Leads	18±1	JM
	Bulk (Tray) – Long Leads	30 +5/-0	40
	Bulk (Tray) – Long Leads	25 +2/-1	50
37.5	Standard Lead and Packaging Options		
	Bulk (Tray) – Short Leads	4 +2/-0	SE
	Other Lead and Packaging Options		
	Bulk (Tray) – Short Leads	3.5 +0.5/-0	JB
	Bulk (Tray) – Short Leads	4.0 +0.5/-0	JE
	Bulk (Tray) – Short Leads	3.2 +0.3/-0.2	JH
	Bulk (Tray) – Long Leads	18±1	JM
	Bulk (Tray) – Long Leads	30 +5/-0	40
	Bulk (Tray) – Long Leads	25 +2/-1	50

¹ = Not for all sizes, see "Packaging Quantities" table.

Dimensions – Millimeters

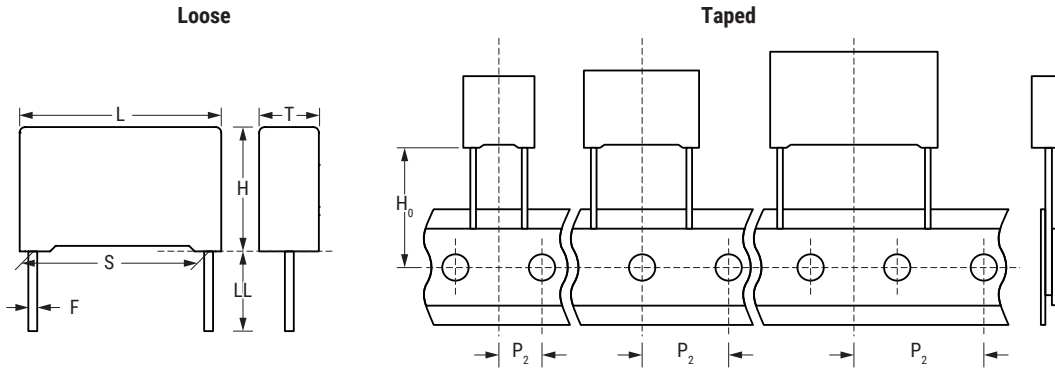

S		T		H		L		F	
Nominal	Tolerance	Nominal	Tolerance	Nominal	Tolerance	Nominal	Tolerance	Nominal	Tolerance
15.0	±0.4	5.0	+0.2/-0.5	11.0	+0.1/-0.5	18.0	+0.3/-0.5	0.8	±0.05
15.0	±0.4	6.0	+0.2/-0.5	12.0	+0.1/-0.5	18.0	+0.3/-0.5	0.8	±0.05
15.0	±0.4	7.5	+0.2/-0.5	13.5	+0.1/-0.5	18.0	+0.5/-0.5	0.8	±0.05
15.0	±0.4	8.5	+0.2/-0.5	14.5	+0.1/-0.5	18.0	+0.5/-0.5	0.8	±0.05
15.0	±0.4	10.0	+0.2/-0.5	16.0	+0.1/-0.5	18.0	+0.5/-0.5	0.8	±0.05
22.5	±0.4	6.0	+0.2/-0.5	15.0	+0.1/-0.5	26.5	+0.3/-0.5	0.8	±0.05
22.5	±0.4	7.0	+0.2/-0.5	16.0	+0.1/-0.5	26.5	+0.3/-0.5	0.8	±0.05
22.5	±0.4	8.5	+0.2/-0.5	17.0	+0.1/-0.5	26.5	+0.3/-0.5	0.8	±0.05
22.5	±0.4	10.0	+0.2/-0.5	18.5	+0.1/-0.5	26.5	+0.3/-0.5	0.8	±0.05
22.5	±0.4	11.0	+0.2/-0.5	20.0	+0.1/-0.5	26.5	+0.3/-0.5	0.8	±0.05
27.5	±0.4	9.0	+0.2/-0.7	17.0	+0.1/-0.7	32.0	+0.3/-0.7	0.8	±0.05
27.5	±0.4	11.0	+0.2/-0.7	20.0	+0.1/-0.7	32.0	+0.3/-0.7	0.8	±0.05
27.5	±0.4	13.0	+0.2/-0.7	22.0	+0.1/-0.7	32.0	+0.3/-0.7	0.8	±0.05
27.5	±0.4	13.0	+0.2/-0.7	25.0	+0.1/-0.7	32.0	+0.3/-0.7	0.8	±0.05
27.5	±0.4	14.0	+0.2/-0.7	28.0	+0.1/-0.7	32.0	+0.3/-0.7	0.8	±0.05
27.5	±0.4	18.0	+0.2/-0.7	33.0	+0.1/-0.7	32.0	+0.3/-0.7	0.8	±0.05
27.5	±0.4	22.0	+0.2/-0.7	37.0	+0.1/-0.7	32.0	+0.3/-0.7	0.8	±0.05
27.5	±0.4	24.0	+0.2/-0.7	15.0	+0.1/-0.7	32.0	+0.3/-0.7	0.8	±0.05
37.5	±0.4	11.0	+0.3/-0.7	22.0	+0.1/-0.7	41.5	+0.3/-0.7	1.0	±0.05
37.5	±0.4	13.0	+0.3/-0.7	24.0	+0.1/-0.7	41.5	+0.3/-0.7	1.0	±0.05
37.5	±0.4	16.0	+0.3/-0.7	28.5	+0.1/-0.7	41.5	+0.3/-0.7	1.0	±0.05
37.5	±0.4	19.0	+0.3/-0.7	32.0	+0.1/-0.7	41.5	+0.3/-0.7	1.0	±0.05
37.5	±0.4	20.0	+0.3/-0.7	40.0	+0.1/-0.7	41.5	+0.3/-0.7	1.0	±0.05
37.5	±0.4	24.0	+0.3/-0.7	44.0	+0.1/-0.7	41.5	+0.3/-0.7	1.0	±0.05
37.5	±0.4	24.0	+0.3/-0.7	15.0	+0.1/-0.7	41.5	+0.3/-0.7	1.0	±0.05
37.5	±0.4	24.0	+0.3/-0.7	19.0	+0.1/-0.7	41.5	+0.3/-0.7	1.0	±0.05
37.5	±0.4	30.0	+0.3/-0.7	45.0	+0.1/-0.7	41.5	+0.3/-0.7	1.0	±0.05

Note: See Ordering Options Table for lead length (LL/Ho) options.

Performance Characteristics

Dielectric	Polypropylene film								
Plates	Metal foil for 1 section, metal foil + metallized film for 2 sections								
Winding	Non-inductive type								
Leads	Tinned wire								
Protection	Plastic case, thermosetting resin filled. Box material is solvent resistant and flame retardant according to UL94.								
Related Documents	IEC 60384-13								
Sections	1				2				
Voltage Range (VDC)	100	160	250	400	630	1,000	1,250	1,600	2,000
Voltage Range (VAC)	63	90	125	160	300	400	450	450	500
Capacitance Range (μF)	0.047 – 0.15	0.033 – 0.1	0.015 – 0.047	0.01 – 0.047	0.01 – 2.2	0.0033 – 1.5	0.0022 – 0.82	0.001 – 0.56	0.0001 – 0.22
Capacitance Values	E6/E12 series (IEC 60063) measured at 1kHz and +20 $\pm 1^\circ\text{C}$								
Capacitance Tolerance	$\pm 5\%$, $\pm 10\%$, $\pm 2.5\%$ only for 2 sections								
Category Temperature Range	-55 $^\circ\text{C}$ to +105 $^\circ\text{C}$								
Rated Temperature T_R	+85 $^\circ\text{C}$								
Voltage Derating	Above +85 $^\circ\text{C}$ DC and AC voltage derating is 1.25%/ $^\circ\text{C}$								
Climatic Category	55/105/56 IEC 60068-1								
Storage Conditions	Storage time: ≤ 24 months from the date marked on the label package								
	Average relative humidity per year $\leq 70\%$								
	RH $\leq 85\%$ for 30 days randomly distributed throughout the year								
	Dew is absent								
Test Voltage	Temperature: -40 to 80 $^\circ\text{C}$ (see "Maximum Humidity in Storage Conditions" graph above)								
	2.5 x V_R VDC for 2 seconds (between terminations) at +25 $^\circ\text{C} \pm 5^\circ\text{C}$ (1 section) 2 x V_R VDC for 2 seconds (between terminations) at +25 $^\circ\text{C} \pm 5^\circ\text{C}$ (2 sections)								
Capacitance Drift	Maximum 0.5% after a 2 year storage period at a temperature of +10 $^\circ\text{C}$ to +40 $^\circ\text{C}$ and a relative humidity of 40% to 60%								
Maximum Pulse Steepness	dV/dt according to Table 1. For working voltages lower than rated voltage ($V < V_R$), the specified dV/dt can be multiplied by the factor V_R/V .								
Temperature Coefficient	-(150 ± 70) ppm/ $^\circ\text{C}$ at 1 kHz								
Self Inductance (Lead Length ~ 2 mm)	Lead Spacing (mm)	15		22.5		27.5		37.5	
	L (nH) \approx	10		16		18		20	
	Maximum 1 nH per 1 mm lead and capacitor length.								
Dissipation Factor $\tan\delta$	Measured at 25 $^\circ\text{C} \pm 5^\circ\text{C}$								
	Frequency	$C \leq 0.1 \mu\text{F}$			$0.1 \mu\text{F} < C \leq 1 \mu\text{F}$			$C > 1 \mu\text{F}$	
	1 kHz	0.03%			0.03%			0.03%	
	10 kHz	0.04%			0.06%			-	
100 kHz	0.10%			-			-		

Performance Characteristics cont.

Insulation Resistance	Measured at +25°C, 100 VDC 60 seconds	
	Minimum Values Between Terminals	
	$C \leq 0.33 \mu\text{F}$	$C > 0.33 \mu\text{F}$
	$\geq 100,000 \text{ M}\Omega$ ($\geq 500,000 \text{ M}\Omega$)*	$\geq 30,000 \text{ M}\Omega \cdot \mu\text{F}$ ($\geq 150,000 \text{ M}\Omega \cdot \mu\text{F}$)*

* Typical value

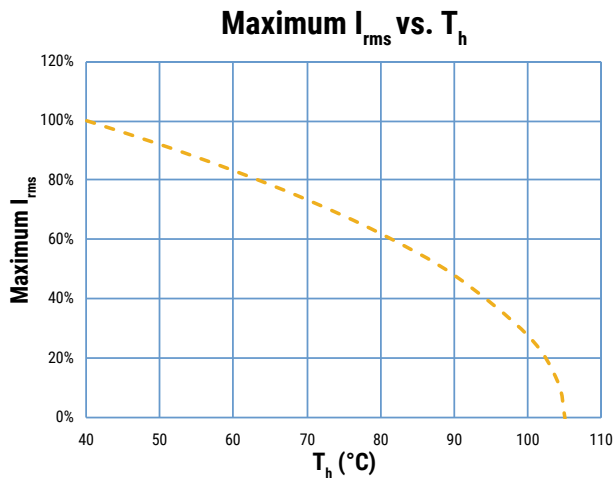
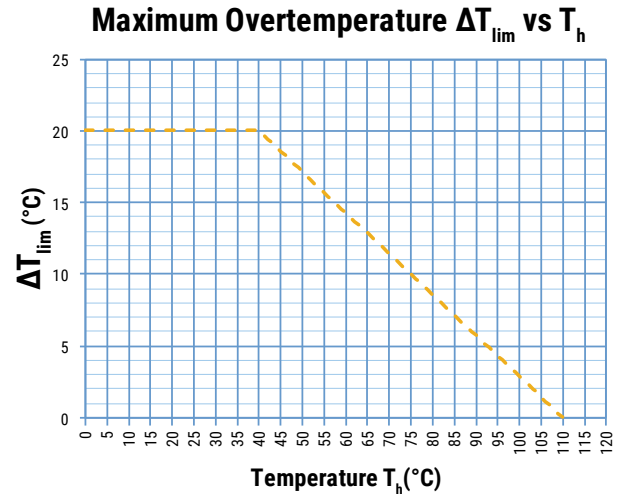
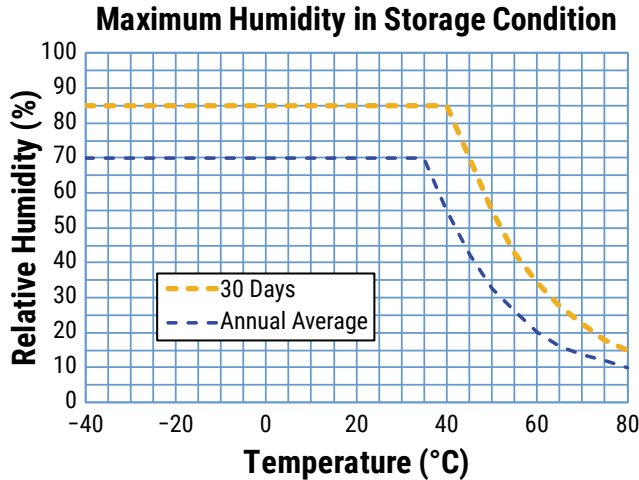

T_h is the maximum ambient temperature surrounding the capacitor or hottest contact point (e.g. tracks), whichever is higher, in the worst operation conditions in °C.

Qualification

Automotive Grade products meet or exceed the requirements outlined by the Automotive Electronics Council. Details regarding test methods and conditions are referenced in document AEC-Q200, Stress Test Qualification for Passive Components. For additional information regarding the Automotive Electronics Council and AEC-Q200, please visit their website at www.aecouncil.com.

Maximum Voltage (V_{rms}) vs. Frequency (Sinusoidal Waveform/ $Th \leq 40^\circ C$)

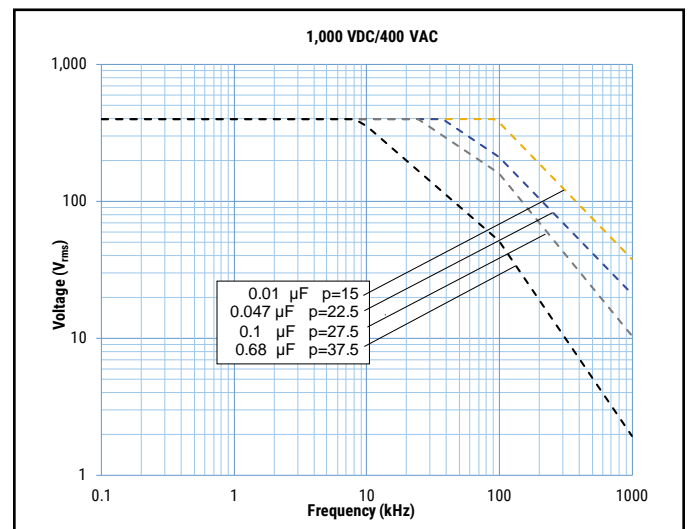
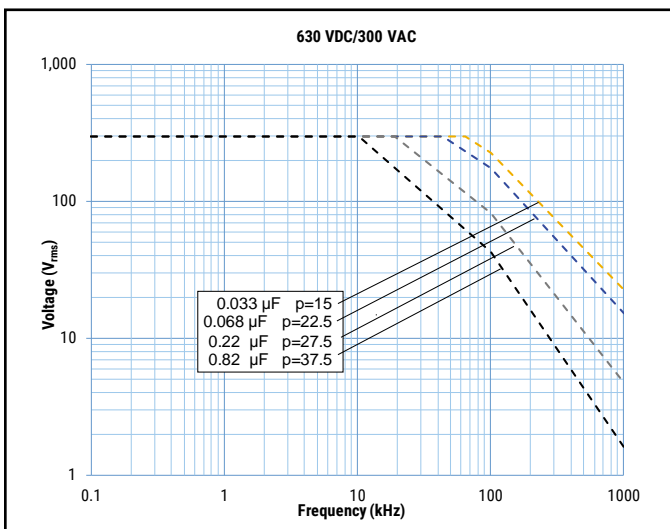
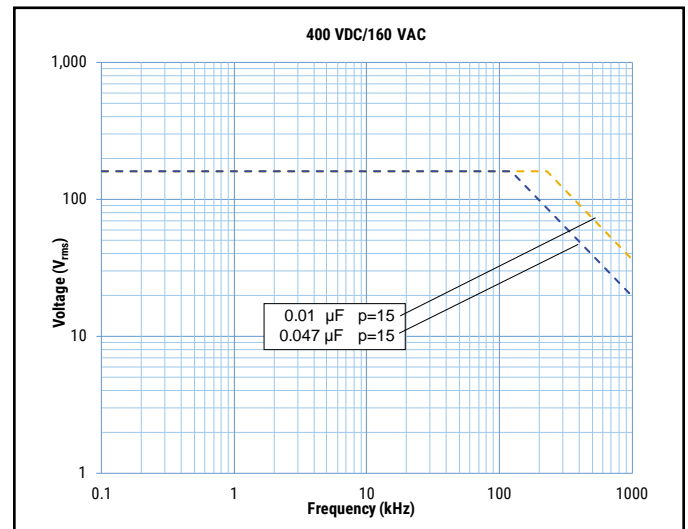
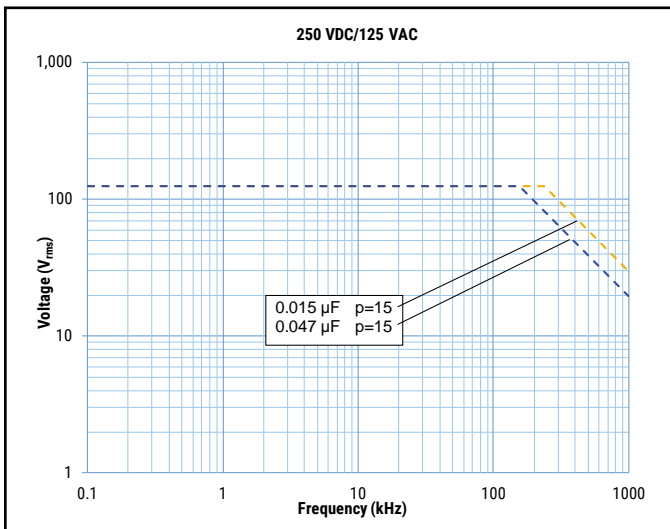
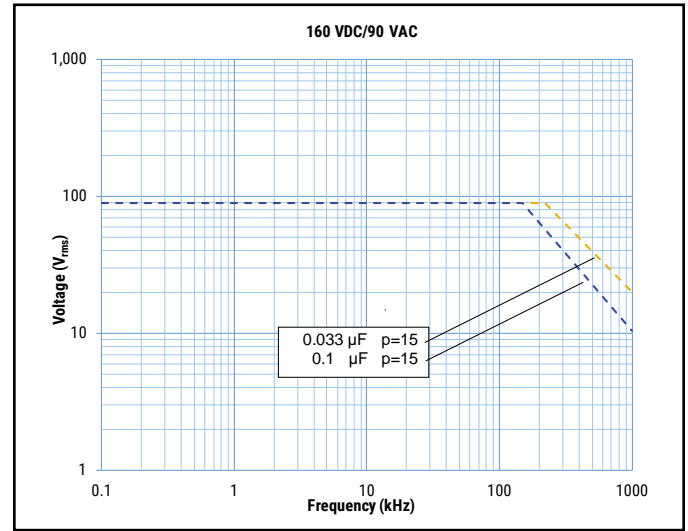
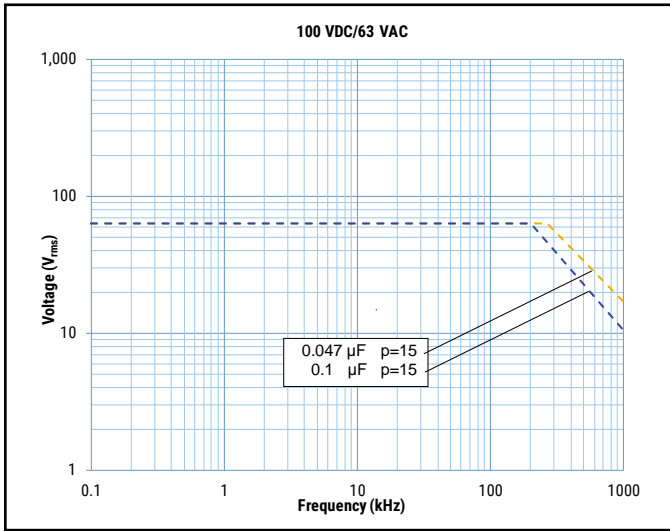

Maximum Voltage (V_{rms}) vs. Frequency (Sinusoidal Waveform/ $T_h \leq 40^\circ C$) cont.

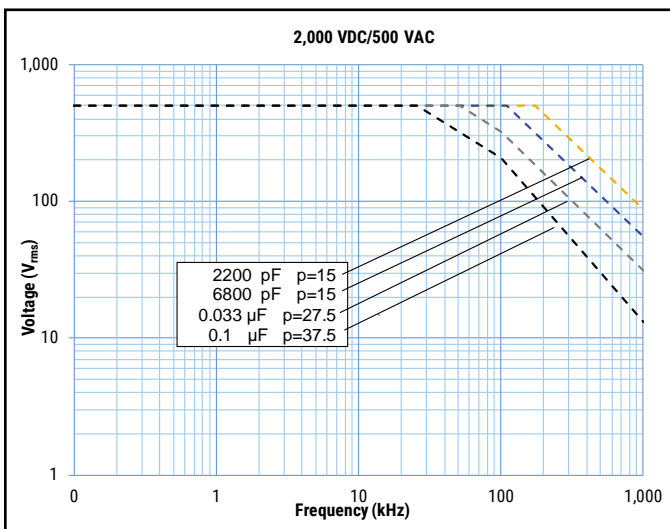
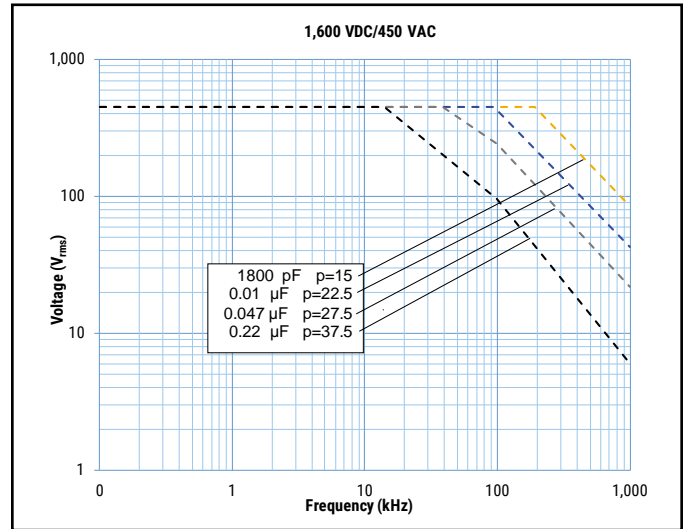
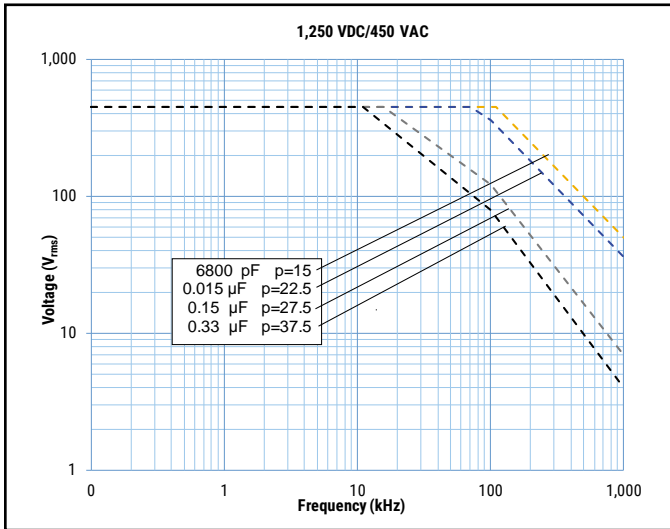

Maximum Current (I_{rms}) vs. Frequency (Sinusoidal Waveform/ $T_h \leq 40^\circ C$)

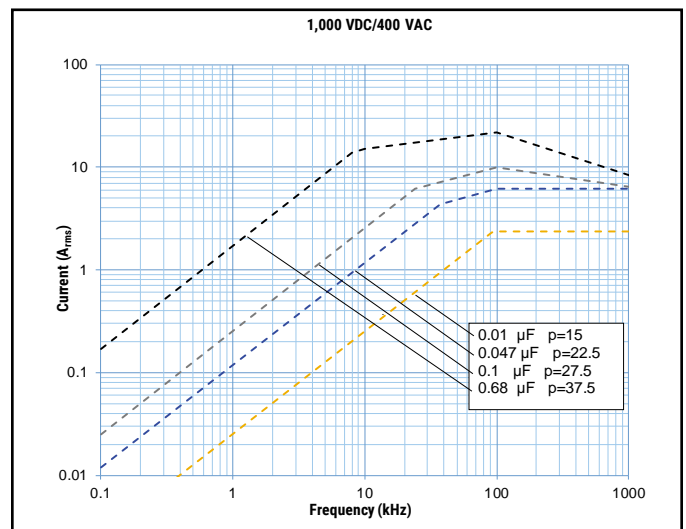
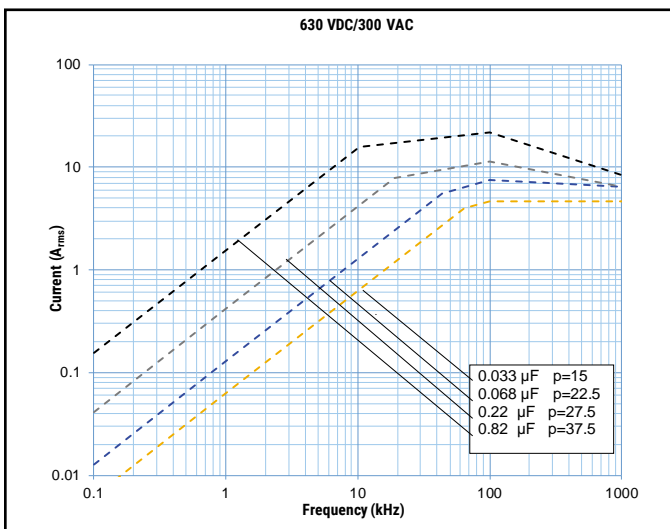
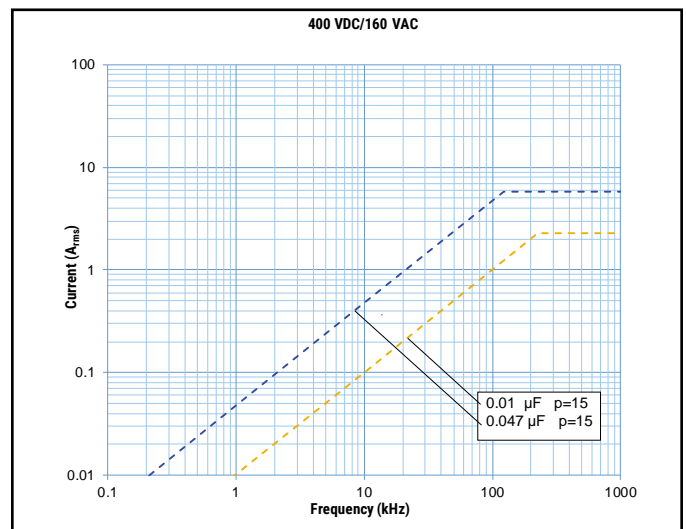
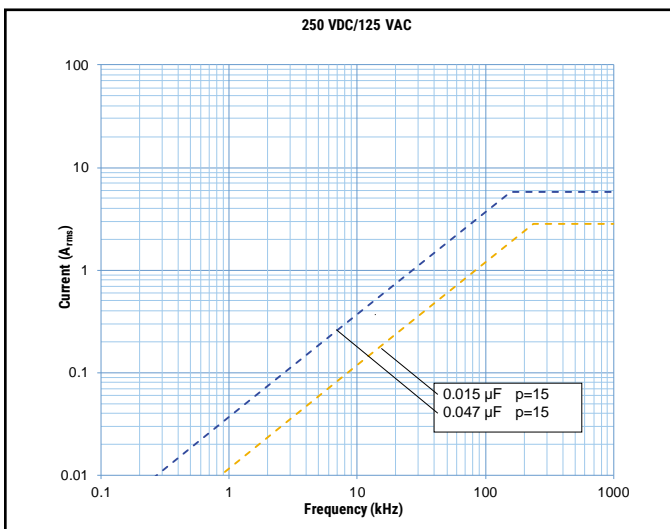
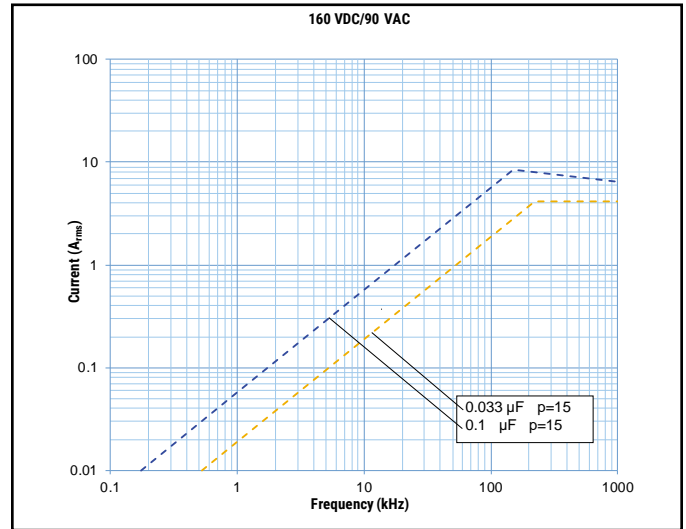
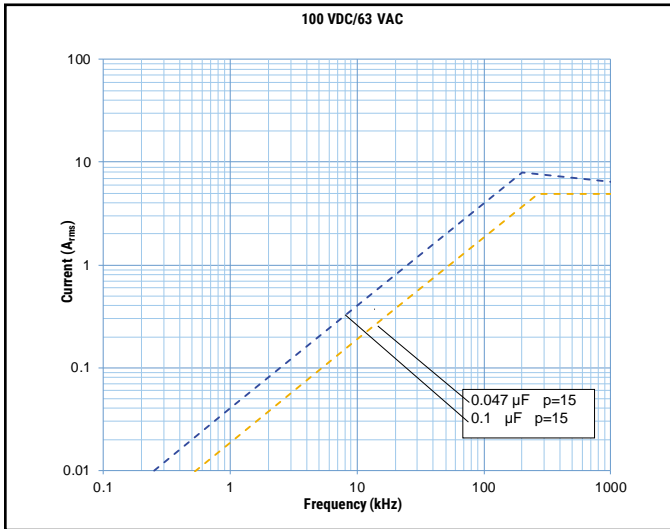

Maximum Current (I_{rms}) vs. Frequency (Sinusoidal Waveform/ $T_h \leq 40^\circ\text{C}$) cont.

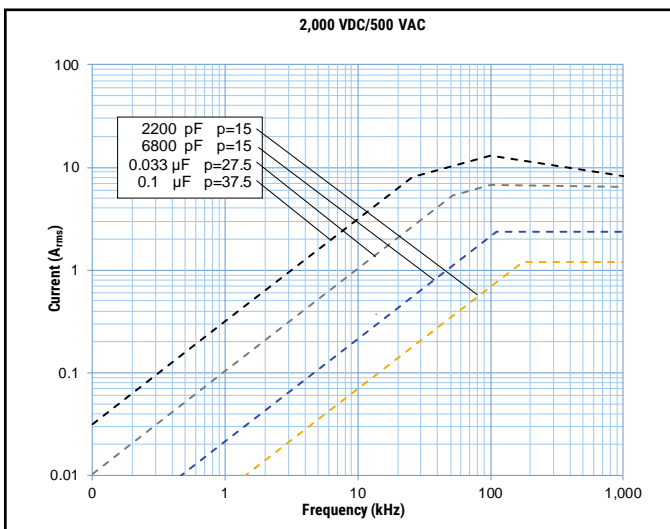
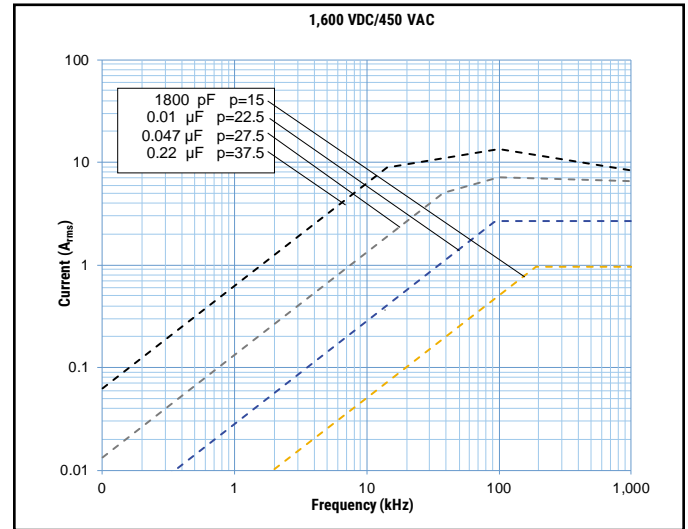
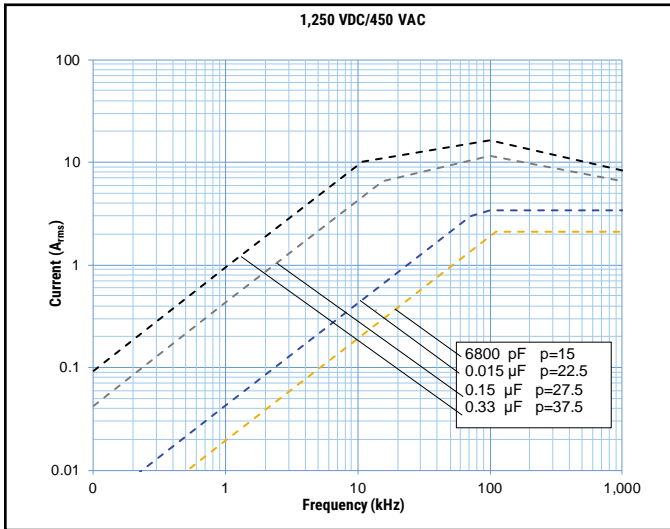

Environmental Test Data

Damp Heat, Steady State Test	Test Conditions:		Performances
	Temperature: Relative humidity (RH): Test duration:	+40°C ±2°C 93% ±2% 56 days	Δ C/C ≤ 2%, Δ tanδ ≤ 0.0005 at 1 kHz IR after test ≥ 50% of initial limit
Endurance Test	Test Conditions		Performances
	Temperature: Voltage applied: Test duration:	+85°C ±2°C 1.5 × V _R (DC) 1,000 hours	Δ C/C ≤ 2%, Δ tanδ ≤ 0.0005 at 1 kHz IR after test ≥ 50% of initial limit
Resistance to Soldering Heat Test	Test Conditions		Performances
	Solder bath temperature: Dipping time (with heat screen):	260°C ±5°C 10 seconds ±1 second	Δ C/C ≤ 1%, Δ tanδ ≤ 0.003 at 1 kHz IR after test ≥ initial limit

Environmental Compliance

All KEMET pulse capacitors are RoHS Compliant.



Table 1 – Ratings & Part Number Reference

VDC	VAC	Capacitance Value (μF)	Dimensions in mm			Lead Spacing (S)	dV/dt (V/μs)	Max K ₀ (V ² /μs)	KEMET Internal Part Number	Customer Part Number
			T	H	L					
100	63	0.047	5.0	11.0	18.0	15.0	2,400	480,000	73EI2470(1)00(2)	R73EI2470(1)00(2)
100	63	0.068	6.0	12.0	18.0	15.0	2,400	480,000	73EI2680(1)00(2)	R73EI2680(1)00(2)
100	63	0.10	7.5	13.5	18.0	15.0	2,400	480,000	73EI3100(1)00(2)	R73EI3100(1)00(2)
100	63	0.15	10.0	16.0	18.0	15.0	2,400	480,000	73EI3150(1)00(2)	R73EI3150(1)00(2)
160	90	0.033	5.0	11.0	18.0	15.0	3,000	960,000	73GI2330(1)00(2)	R73GI2330(1)00(2)
160	90	0.047	6.0	12.0	18.0	15.0	3,000	960,000	73GI2470(1)00(2)	R73GI2470(1)00(2)
160	90	0.068	7.5	13.5	18.0	15.0	3,000	960,000	73GI2680(1)00(2)	R73GI2680(1)00(2)
160	90	0.10	10.0	16.0	18.0	15.0	3,000	960,000	73GI3100(1)00(2)	R73GI3100(1)00(2)
250	125	0.015	5.0	11.0	18.0	15.0	4,800	2,400,000	73II2150(1)00(2)	R73II2150(1)00(2)
250	125	0.022	6.0	12.0	18.0	15.0	4,800	2,400,000	73II2220(1)00(2)	R73II2220(1)00(2)
VDC	VAC	Capacitance Value (μF)	T (mm)	H (mm)	L (mm)	Lead Spacing (S)	dV/dt (V/μs)	Max K ₀ (V ² /μs)	KEMET Internal Part Number	Customer Part Number

(1) Insert lead and packaging code. See Ordering Options Table for available options.

(2) J = 5%, K = 10%

Table 1 – Ratings & Part Number Reference cont.

VDC	VAC	Capacitance Value (µF)	Dimensions in mm			Lead Spacing (S)	dV/dt (V/µs)	Max K ₀ (V ² /µs)	KEMET Internal Part Number	Customer Part Number
			T	H	L					
250	125	0.033	7.5	13.5	18.0	15.0	4,800	2,400,000	73I12330(1)00(2)	R73I12330(1)00(2)
250	125	0.047	10.0	16.0	18.0	15.0	4,800	2,400,000	73I12470(1)00(2)	R73I12470(1)00(2)
400	160	0.010	5.0	11.0	18.0	15.0	6,000	4,800,000	73MI2100(1)00(2)	R73MI2100(1)00(2)
400	160	0.015	6.0	12.0	18.0	15.0	6,000	4,800,000	73MI2150(1)00(2)	R73MI2150(1)00(2)
400	160	0.022	7.5	13.5	18.0	15.0	6,000	4,800,000	73MI2220(1)00(2)	R73MI2220(1)00(2)
400	160	0.033	8.5	14.5	18.0	15.0	6,000	4,800,000	73MI2330(1)00(2)	R73MI2330(1)00(2)
400	160	0.047	10.0	16.0	18.0	15.0	6,000	4,800,000	73MI2470(1)00(2)	R73MI2470(1)00(2)
630	300	0.010	5.0	11.0	18.0	15.0	11,000	13,860,000	73PI2100(1)00(2)	R73PI2100(1)00(2)
630	300	0.012	5.0	11.0	18.0	15.0	11,000	13,860,000	73PI2120(1)00(2)	R73PI2120(1)00(2)
630	300	0.015	6.0	12.0	18.0	15.0	11,000	13,860,000	73PI2150(1)00(2)	R73PI2150(1)00(2)
630	300	0.018	6.0	12.0	18.0	15.0	11,000	13,860,000	73PI2180(1)00(2)	R73PI2180(1)00(2)
630	300	0.022	7.5	13.5	18.0	15.0	11,000	13,860,000	73PI2220(1)00(2)	R73PI2220(1)00(2)
630	300	0.027	7.5	13.5	18.0	15.0	11,000	13,860,000	73PI2270(1)00(2)	R73PI2270(1)00(2)
630	300	0.033	8.5	14.5	18.0	15.0	11,000	13,860,000	73PI2330(1)00(2)	R73PI2330(1)00(2)
630	300	0.039	10.0	16.0	18.0	15.0	11,000	13,860,000	73PI2390(1)00(2)	R73PI2390(1)00(2)
630	300	0.047	10.0	16.0	18.0	15.0	11,000	13,860,000	73PI2470(1)00(2)	R73PI2470(1)00(2)
630	300	0.039	6.0	15.0	26.5	22.5	11,000	13,860,000	73PN2390(1)00(2)	R73PN2390(1)00(2)
630	300	0.047	7.0	16.0	26.5	22.5	11,000	13,860,000	73PN2470(1)00(2)	R73PN2470(1)00(2)
630	300	0.056	7.0	16.0	26.5	22.5	11,000	13,860,000	73PN2560(1)00(2)	R73PN2560(1)00(2)
630	300	0.068	8.5	17.0	26.5	22.5	11,000	13,860,000	73PN2680(1)00(2)	R73PN2680(1)00(2)
630	300	0.082	10.0	18.5	26.5	22.5	11,000	13,860,000	73PN2820(1)00(2)	R73PN2820(1)00(2)
630	300	0.10	10.0	18.5	26.5	22.5	11,000	13,860,000	73PN3100(1)00(2)	R73PN3100(1)00(2)
630	300	0.10	9.0	17.0	32.0	27.5	11,000	13,860,000	73PR3100(1)00(2)	R73PR3100(1)00(2)
630	300	0.12	9.0	17.0	32.0	27.5	11,000	13,860,000	73PR3120(1)00(2)	R73PR3120(1)00(2)
630	300	0.15	11.0	20.0	32.0	27.5	11,000	13,860,000	73PR3150(1)00(2)	R73PR3150(1)00(2)
630	300	0.18	11.0	20.0	32.0	27.5	11,000	13,860,000	73PR3180(1)10(2)	R73PR3180(1)10(2)
630	300	0.18	13.0	22.0	32.0	27.5	11,000	13,860,000	73PR3180(1)00(2)	R73PR3180(1)00(2)
630	300	0.18	24.0	15.0	32.0	27.5	11,000	13,860,000	73PR3180(1)L0(2)	R73PR3180(1)L0(2)
630	300	0.22	13.0	22.0	32.0	27.5	11,000	13,860,000	73PR3220(1)00(2)	R73PR3220(1)00(2)
630	300	0.22	24.0	15.0	32.0	27.5	11,000	13,860,000	73PR3220(1)L0(2)	R73PR3220(1)L0(2)
630	300	0.27	13.0	25.0	32.0	27.5	11,000	13,860,000	73PR3270(1)10(2)	R73PR3270(1)10(2)
630	300	0.27	24.0	15.0	32.0	27.5	11,000	13,860,000	73PR3270(1)L0(2)	R73PR3270(1)L0(2)
630	300	0.33	14.0	28.0	32.0	27.5	11,000	13,860,000	73PR3330(1)00(2)	R73PR3330(1)00(2)
630	300	0.33	24.0	15.0	32.0	27.5	11,000	13,860,000	73PR3330(1)L0(2)	R73PR3330(1)L0(2)
630	300	0.39	14.0	28.0	32.0	27.5	11,000	13,860,000	73PR3390(1)10(2)	R73PR3390(1)10(2)
630	300	0.39	18.0	33.0	32.0	27.5	11,000	13,860,000	73PR3390(1)00(2)	R73PR3390(1)00(2)
630	300	0.47	18.0	33.0	32.0	27.5	11,000	13,860,000	73PR3470(1)00(2)	R73PR3470(1)00(2)
630	300	0.56	18.0	33.0	32.0	27.5	11,000	13,860,000	73PR3560(1)10(2)	R73PR3560(1)10(2)
630	300	0.56	22.0	37.0	32.0	27.5	11,000	13,860,000	73PR3560(1)00(2)	R73PR3560(1)00(2)
630	300	0.68	22.0	37.0	32.0	27.5	11,000	13,860,000	73PR3680(1)00(2)	R73PR3680(1)00(2)
630	300	0.82	22.0	37.0	32.0	27.5	11,000	13,860,000	73PR3820(1)10(2)	R73PR3820(1)10(2)
630	300	0.22	11.0	22.0	41.5	37.5	3,000	3,780,000	73PW3220(1)00(2)	R73PW3220(1)00(2)
630	300	0.27	11.0	22.0	41.5	37.5	3,000	3,780,000	73PW3270(1)00(2)	R73PW3270(1)00(2)
630	300	0.27	24.0	15.0	41.5	37.5	3,000	3,780,000	73PW3270(1)L0(2)	R73PW3270(1)L0(2)
630	300	0.33	11.0	22.0	41.5	37.5	3,000	3,780,000	73PW3330(1)10(2)	R73PW3330(1)10(2)
630	300	0.33	13.0	24.0	41.5	37.5	3,000	3,780,000	73PW3330(1)00(2)	R73PW3330(1)00(2)
630	300	0.33	24.0	15.0	41.5	37.5	3,000	3,780,000	73PW3330(1)L0(2)	R73PW3330(1)L0(2)
630	300	0.39	13.0	24.0	41.5	37.5	3,000	3,780,000	73PW3390(1)00(2)	R73PW3390(1)00(2)
630	300	0.39	24.0	15.0	41.5	37.5	3,000	3,780,000	73PW3390(1)L0(2)	R73PW3390(1)L0(2)
630	300	0.47	13.0	24.0	41.5	37.5	3,000	3,780,000	73PW3470(1)10(2)	R73PW3470(1)10(2)
630	300	0.47	16.0	28.5	41.5	37.5	3,000	3,780,000	73PW3470(1)00(2)	R73PW3470(1)00(2)
630	300	0.47	24.0	15.0	41.5	37.5	3,000	3,780,000	73PW3470(1)L0(2)	R73PW3470(1)L0(2)
630	300	0.56	16.0	28.5	41.5	37.5	3,000	3,780,000	73PW3560(1)00(2)	R73PW3560(1)00(2)
630	300	0.56	24.0	19.0	41.5	37.5	3,000	3,780,000	73PW3560(1)L0(2)	R73PW3560(1)L0(2)
630	300	0.68	16.0	28.5	41.5	37.5	3,000	3,780,000	73PW3680(1)00(2)	R73PW3680(1)00(2)
630	300	0.68	24.0	19.0	41.5	37.5	3,000	3,780,000	73PW3680(1)L0(2)	R73PW3680(1)L0(2)
630	300	0.82	19.0	32.0	41.5	37.5	3,000	3,780,000	73PW3820(1)00(2)	R73PW3820(1)00(2)
630	300	1.0	20.0	40.0	41.5	37.5	3,000	3,780,000	73PW4100(1)00(2)	R73PW4100(1)00(2)
630	300	1.2	20.0	40.0	41.5	37.5	3,000	3,780,000	73PW4120(1)00(2)	R73PW4120(1)00(2)
VDC	VAC	Capacitance Value (µF)	T (mm)	H (mm)	L (mm)	Lead Spacing (S)	dV/dt (V/µs)	Max K ₀ (V ² /µs)	KEMET Internal Part Number	Customer Part Number

(1) Insert lead and packaging code. See Ordering Options Table for available options.

(2) J = 5%, K = 10%

Table 1 – Ratings & Part Number Reference cont.

VDC	VAC	Capacitance Value (µF)	Dimensions in mm			Lead Spacing (S)	dV/dt (V/µs)	Max K ₀ (V ² /µs)	KEMET Internal Part Number	Customer Part Number
			T	H	L					
630	300	1.5	24.0	44.0	41.5	37.5	3,000	3,780,000	73PW4150(1)00(2)	R73PW4150(1)00(2)
630	300	1.8	30.0	45.0	41.5	37.5	3,000	3,780,000	73PW4180(1)00(2)	R73PW4180(1)00(2)
630	300	2.2	30.0	45.0	41.5	37.5	3,000	3,780,000	73PW4220(1)00(2)	R73PW4220(1)00(2)
1,000	400	0.0033	5.0	11.0	18.0	15.0	28,000	56,000,000	73QI1330(1)30(2)	R73QI1330(1)30(2)
1,000	400	0.0039	5.0	11.0	18.0	15.0	28,000	56,000,000	73QI1390(1)30(2)	R73QI1390(1)30(2)
1,000	400	0.0047	5.0	11.0	18.0	15.0	28,000	56,000,000	73QI1470(1)30(2)	R73QI1470(1)30(2)
1,000	400	0.0056	5.0	11.0	18.0	15.0	28,000	56,000,000	73QI1560(1)30(2)	R73QI1560(1)30(2)
1,000	400	0.0068	5.0	11.0	18.0	15.0	28,000	56,000,000	73QI1680(1)30(2)	R73QI1680(1)30(2)
1,000	400	0.0082	5.0	11.0	18.0	15.0	28,000	56,000,000	73QI1820(1)30(2)	R73QI1820(1)30(2)
1,000	400	0.010	6.0	12.0	18.0	15.0	28,000	56,000,000	73QI2100(1)30(2)	R73QI2100(1)30(2)
1,000	400	0.012	6.0	12.0	18.0	15.0	28,000	56,000,000	73QI2120(1)30(2)	R73QI2120(1)30(2)
1,000	400	0.015	7.5	13.5	18.0	15.0	28,000	56,000,000	73QI2150(1)30(2)	R73QI2150(1)30(2)
1,000	400	0.018	8.5	14.5	18.0	15.0	28,000	56,000,000	73QI2180(1)30(2)	R73QI2180(1)30(2)
1,000	400	0.022	8.5	14.5	18.0	15.0	28,000	56,000,000	73QI2220(1)30(2)	R73QI2220(1)30(2)
1,000	400	0.027	10.0	16.0	18.0	15.0	28,000	56,000,000	73QI2270(1)30(2)	R73QI2270(1)30(2)
1,000	400	0.015	6.0	15.0	26.5	22.5	11,000	22,000,000	73QN2150(1)30(2)	R73QN2150(1)30(2)
1,000	400	0.018	6.0	15.0	26.5	22.5	11,000	22,000,000	73QN2180(1)30(2)	R73QN2180(1)30(2)
1,000	400	0.022	6.0	15.0	26.5	22.5	11,000	22,000,000	73QN2220(1)30(2)	R73QN2220(1)30(2)
1,000	400	0.027	7.0	16.0	26.5	22.5	11,000	22,000,000	73QN2270(1)30(2)	R73QN2270(1)30(2)
1,000	400	0.033	7.0	16.0	26.5	22.5	11,000	22,000,000	73QN2330(1)30(2)	R73QN2330(1)30(2)
1,000	400	0.039	8.5	17.0	26.5	22.5	11,000	22,000,000	73QN2390(1)30(2)	R73QN2390(1)30(2)
1,000	400	0.047	10.0	18.5	26.5	22.5	11,000	22,000,000	73QN2470(1)30(2)	R73QN2470(1)30(2)
1,000	400	0.056	10.0	18.5	26.5	22.5	11,000	22,000,000	73QN2560(1)30(2)	R73QN2560(1)30(2)
1,000	400	0.068	11.0	20.0	26.5	22.5	11,000	22,000,000	73QN2680(1)30(2)	R73QN2680(1)30(2)
1,000	400	0.047	9.0	17.0	32.0	27.5	11,000	22,000,000	73QR2470(1)30(2)	R73QR2470(1)30(2)
1,000	400	0.056	9.0	17.0	32.0	27.5	11,000	22,000,000	73QR2560(1)30(2)	R73QR2560(1)30(2)
1,000	400	0.068	9.0	17.0	32.0	27.5	11,000	22,000,000	73QR2680(1)30(2)	R73QR2680(1)30(2)
1,000	400	0.082	9.0	17.0	32.0	27.5	11,000	22,000,000	73QR2820(1)40(2)	R73QR2820(1)40(2)
1,000	400	0.082	11.0	20.0	32.0	27.5	11,000	22,000,000	73QR2820(1)30(2)	R73QR2820(1)30(2)
1,000	400	0.10	11.0	20.0	32.0	27.5	11,000	22,000,000	73QR3100(1)30(2)	R73QR3100(1)30(2)
1,000	400	0.10	24.0	15.0	32.0	27.5	11,000	22,000,000	73QR3100(1)L0(2)	R73QR3100(1)L0(2)
1,000	400	0.12	11.0	20.0	32.0	27.5	11,000	22,000,000	73QR3120(1)40(2)	R73QR3120(1)40(2)
1,000	400	0.12	13.0	22.0	32.0	27.5	11,000	22,000,000	73QR3120(1)30(2)	R73QR3120(1)30(2)
1,000	400	0.12	24.0	15.0	32.0	27.5	11,000	22,000,000	73QR3120(1)L0(2)	R73QR3120(1)L0(2)
1,000	400	0.15	13.0	22.0	32.0	27.5	11,000	22,000,000	73QR3150(1)30(2)	R73QR3150(1)30(2)
1,000	400	0.15	25.0	15.0	32.0	27.5	11,000	22,000,000	73QR3150(1)L0(2)	R73QR3150(1)L0(2)
1,000	400	0.18	13.0	25.0	32.0	27.5	11,000	22,000,000	73QR3180(1)40(2)	R73QR3180(1)40(2)
1,000	400	0.18	24.0	15.0	32.0	27.5	11,000	22,000,000	73QR3180(1)L0(2)	R73QR3180(1)L0(2)
1,000	400	0.22	14.0	28.0	32.0	27.5	11,000	22,000,000	73QR3220(1)30(2)	R73QR3220(1)30(2)
1,000	400	0.27	18.0	33.0	32.0	27.5	11,000	22,000,000	73QR3270(1)30(2)	R73QR3270(1)30(2)
1,000	400	0.33	18.0	33.0	32.0	27.5	11,000	22,000,000	73QR3330(1)30(2)	R73QR3330(1)30(2)
1,000	400	0.47	22.0	37.0	32.0	27.5	11,000	22,000,000	73QR3470(1)30(2)	R73QR3470(1)30(2)
1,000	400	0.12	11.0	22.0	41.5	37.5	4,500	9,000,000	73QW3120(1)30(2)	R73QW3120(1)30(2)
1,000	400	0.15	11.0	22.0	41.5	37.5	4,500	9,000,000	73QW3150(1)30(2)	R73QW3150(1)30(2)
1,000	400	0.15	24.0	15.0	41.5	37.5	4,500	9,000,000	73QW3150(1)L0(2)	R73QW3150(1)L0(2)
1,000	400	0.18	11.0	22.0	41.5	37.5	4,500	9,000,000	73QW3180(1)30(2)	R73QW3180(1)30(2)
1,000	400	0.18	24.0	15.0	41.5	37.5	4,500	9,000,000	73QW3180(1)L0(2)	R73QW3180(1)L0(2)
1,000	400	0.22	13.0	24.0	41.5	37.5	4,500	9,000,000	73QW3220(1)30(2)	R73QW3220(1)30(2)
1,000	400	0.22	24.0	15.0	41.5	37.5	4,500	9,000,000	73QW3220(1)L0(2)	R73QW3220(1)L0(2)
1,000	400	0.27	13.0	24.0	41.5	37.5	4,500	9,000,000	73QW3270(1)40(2)	R73QW3270(1)40(2)
1,000	400	0.27	16.0	28.5	41.5	37.5	4,500	9,000,000	73QW3270(1)30(2)	R73QW3270(1)30(2)
1,000	400	0.27	24.0	15.0	41.5	37.5	4,500	9,000,000	73QW3270(1)L0(2)	R73QW3270(1)L0(2)
1,000	400	0.33	16.0	28.5	41.5	37.5	4,500	9,000,000	73QW3330(1)30(2)	R73QW3330(1)30(2)
1,000	400	0.33	24.0	19.0	41.5	37.5	4,500	9,000,000	73QW3330(1)L0(2)	R73QW3330(1)L0(2)
1,000	400	0.39	16.0	28.5	41.5	37.5	4,500	9,000,000	73QW3390(1)30(2)	R73QW3390(1)30(2)
1,000	400	0.47	19.0	32.0	41.5	37.5	4,500	9,000,000	73QW3470(1)30(2)	R73QW3470(1)30(2)
1,000	400	0.56	19.0	32.0	41.5	37.5	4,500	9,000,000	73QW3560(1)30(2)	R73QW3560(1)30(2)
1,000	400	0.68	20.0	40.0	41.5	37.5	4,500	9,000,000	73QW3680(1)30(2)	R73QW3680(1)30(2)
1,000	400	0.82	20.0	40.0	41.5	37.5	4,500	9,000,000	73QW3820(1)30(2)	R73QW3820(1)30(2)
1,000	400	1.0	24.0	44.0	41.5	37.5	4,500	9,000,000	73QW4100(1)30(2)	R73QW4100(1)30(2)
VDC	VAC	Capacitance Value (µF)	T (mm)	H (mm)	L (mm)	Lead Spacing (S)	dV/dt (V/µs)	Max K ₀ (V ² /µs)	KEMET Internal Part Number	Customer Part Number

(1) Insert lead and packaging code. See Ordering Options Table for available options.

(2) H = 2.5%, J = 5%, K = 10%, M = 20%

Table 1 – Ratings & Part Number Reference cont.

VDC	VAC	Capacitance Value (µF)	Dimensions in mm			Lead Spacing (S)	dV/dt (V/µs)	Max K ₀ (V ² /µs)	KEMET Internal Part Number	Customer Part Number
			T	H	L					
1,000	400	1.2	30.0	45.0	41.5	37.5	4,500	9,000,000	73QW4120(1)30(2)	R73QW4120(1)30(2)
1,000	400	1.5	30.0	45.0	41.5	37.5	4,500	9,000,000	73QW4150(1)40(2)	R73QW4150(1)40(2)
1,250	450	0.0022	5.0	11.0	18.0	15.0	30,000	75,000,000	73RI1220(1)00(2)	R73RI1220(1)00(2)
1,250	450	0.0027	5.0	11.0	18.0	15.0	30,000	75,000,000	73RI1270(1)00(2)	R73RI1270(1)00(2)
1,250	450	0.0033	6.0	12.0	18.0	15.0	30,000	75,000,000	73RI1330(1)00(2)	R73RI1330(1)00(2)
1,250	450	0.0039	6.0	12.0	18.0	15.0	30,000	75,000,000	73RI1390(1)00(2)	R73RI1390(1)00(2)
1,250	450	0.0047	7.5	13.5	18.0	15.0	30,000	75,000,000	73RI1470(1)00(2)	R73RI1470(1)00(2)
1,250	450	0.0056	7.5	13.5	18.0	15.0	30,000	75,000,000	73RI1560(1)00(2)	R73RI1560(1)00(2)
1,250	450	0.0068	8.5	14.5	18.0	15.0	30,000	75,000,000	73RI1680(1)00(2)	R73RI1680(1)00(2)
1,250	450	0.0082	10.0	16.0	18.0	15.0	30,000	75,000,000	73RI1820(1)00(2)	R73RI1820(1)00(2)
1,250	450	0.0082	6.0	15.0	26.5	22.5	11,000	27,500,000	73RN1820(1)00(2)	R73RN1820(1)00(2)
1,250	450	0.010	6.0	15.0	26.5	22.5	11,000	27,500,000	73RN2100(1)00(2)	R73RN2100(1)00(2)
1,250	450	0.012	6.0	15.0	26.5	22.5	11,000	27,500,000	73RN2120(1)00(2)	R73RN2120(1)00(2)
1,250	450	0.015	7.0	16.0	26.5	22.5	11,000	27,500,000	73RN2150(1)00(2)	R73RN2150(1)00(2)
1,250	450	0.018	7.0	16.0	26.5	22.5	11,000	27,500,000	73RN2180(1)00(2)	R73RN2180(1)00(2)
1,250	450	0.022	8.5	17.0	26.5	22.5	11,000	27,500,000	73RN2220(1)00(2)	R73RN2220(1)00(2)
1,250	450	0.027	10.0	18.5	26.5	22.5	11,000	27,500,000	73RN2270(1)00(2)	R73RN2270(1)00(2)
1,250	450	0.033	10.0	18.5	26.5	22.5	11,000	27,500,000	73RN2330(1)00(2)	R73RN2330(1)00(2)
1,250	450	0.039	9.0	17.0	32.0	27.5	11,000	27,500,000	73RR2390(1)00(2)	R73RR2390(1)00(2)
1,250	450	0.047	11.0	20.0	32.0	27.5	11,000	27,500,000	73RR2470(1)00(2)	R73RR2470(1)00(2)
1,250	450	0.056	11.0	20.0	32.0	27.5	11,000	27,500,000	73RR2560(1)00(2)	R73RR2560(1)00(2)
1,250	450	0.056	24.0	15.0	32.0	27.5	11,000	27,500,000	73RR2560(1)L0(2)	R73RR2560(1)L0(2)
1,250	450	0.068	13.0	22.0	32.0	27.5	11,000	27,500,000	73RR2680(1)00(2)	R73RR2680(1)00(2)
1,250	450	0.068	24.0	15.0	32.0	27.5	11,000	27,500,000	73RR2680(1)L0(2)	R73RR2680(1)L0(2)
1,250	450	0.082	13.0	25.0	32.0	27.5	11,000	27,500,000	73RR2820(1)10(2)	R73RR2820(1)10(2)
1,250	450	0.082	24.0	15.0	32.0	27.5	11,000	27,500,000	73RR2820(1)L0(2)	R73RR2820(1)L0(2)
1,250	450	0.10	13.0	25.0	32.0	27.5	11,000	27,500,000	73RR3100(1)10(2)	R73RR3100(1)10(2)
1,250	450	0.10	24.0	15.0	32.0	27.5	11,000	27,500,000	73RR3100(1)L0(2)	R73RR3100(1)L0(2)
1,250	450	0.12	14.0	28.0	32.0	27.5	11,000	27,500,000	73RR3120(1)10(2)	R73RR3120(1)10(2)
1,250	450	0.12	18.0	33.0	32.0	27.5	11,000	27,500,000	73RR3120(1)00(2)	R73RR3120(1)00(2)
1,250	450	0.15	18.0	33.0	32.0	27.5	11,000	27,500,000	73RR3150(1)00(2)	R73RR3150(1)00(2)
1,250	450	0.18	18.0	33.0	32.0	27.5	11,000	27,500,000	73RR3180(1)00(2)	R73RR3180(1)00(2)
1,250	450	0.22	22.0	37.0	32.0	27.5	11,000	27,500,000	73RR3220(1)00(2)	R73RR3220(1)00(2)
1,250	450	0.082	11.0	22.0	41.5	37.5	5,500	13,750,000	73RW2820(1)00(2)	R73RW2820(1)00(2)
1,250	450	0.10	11.0	22.0	41.5	37.5	5,500	13,750,000	73RW3100(1)00(2)	R73RW3100(1)00(2)
1,250	450	0.10	24.0	15.0	41.5	37.5	5,500	13,750,000	73RW3100(1)L0(2)	R73RW3100(1)L0(2)
1,250	450	0.12	11.0	22.0	41.5	37.5	5,500	13,750,000	73RW3120(1)10(2)	R73RW3120(1)10(2)
1,250	450	0.12	13.0	24.0	41.5	37.5	5,500	13,750,000	73RW3120(1)00(2)	R73RW3120(1)00(2)
1,250	450	0.12	24.0	15.0	41.5	37.5	5,500	13,750,000	73RW3120(1)L0(2)	R73RW3120(1)L0(2)
1,250	450	0.15	13.0	24.0	41.5	37.5	5,500	13,750,000	73RW3150(1)00(2)	R73RW3150(1)00(2)
1,250	450	0.15	24.0	15.0	41.5	37.5	5,500	13,750,000	73RW3150(1)L0(2)	R73RW3150(1)L0(2)
1,250	450	0.18	13.0	24.0	41.5	37.5	5,500	13,750,000	73RW3180(1)10(2)	R73RW3180(1)10(2)
1,250	450	0.18	16.0	28.5	41.5	37.5	5,500	13,750,000	73RW3180(1)00(2)	R73RW3180(1)00(2)
1,250	450	0.18	24.0	15.0	41.5	37.5	5,500	13,750,000	73RW3180(1)L0(2)	R73RW3180(1)L0(2)
1,250	450	0.22	16.0	28.5	41.5	37.5	5,500	13,750,000	73RW3220(1)00(2)	R73RW3220(1)00(2)
1,250	450	0.22	24.0	19.0	41.5	37.5	5,500	13,750,000	73RW3220(1)L0(2)	R73RW3220(1)L0(2)
1,250	450	0.27	16.0	28.5	41.5	37.5	5,500	13,750,000	73RW3270(1)00(2)	R73RW3270(1)00(2)
1,250	450	0.33	19.0	32.0	41.5	37.5	5,500	13,750,000	73RW3330(1)00(2)	R73RW3330(1)00(2)
1,250	450	0.39	20.0	40.0	41.5	37.5	5,500	13,750,000	73RW3390(1)00(2)	R73RW3390(1)00(2)
1,250	450	0.47	20.0	40.0	41.5	37.5	5,500	13,750,000	73RW3470(1)00(2)	R73RW3470(1)00(2)
1,250	450	0.56	20.0	40.0	41.5	37.5	5,500	13,750,000	73RW3560(1)00(2)	R73RW3560(1)00(2)
1,250	450	0.68	24.0	44.0	41.5	37.5	5,500	13,750,000	73RW3680(1)00(2)	R73RW3680(1)00(2)
1,250	450	0.82	30.0	45.0	41.5	37.5	5,500	13,750,000	73RW3820(1)00(2)	R73RW3820(1)00(2)
1,600	450	0.0010	5.0	11.0	18.0	15.0	34,000	108,800,000	73TI1100(1)00(2)	R73TI1100(1)00(2)
1,600	450	0.0012	5.0	11.0	18.0	15.0	34,000	108,800,000	73TI1120(1)00(2)	R73TI1120(1)00(2)
1,600	450	0.0015	5.0	11.0	18.0	15.0	34,000	108,800,000	73TI1150(1)00(2)	R73TI1150(1)00(2)
1,600	450	0.0018	5.0	11.0	18.0	15.0	34,000	108,800,000	73TI1180(1)00(2)	R73TI1180(1)00(2)
1,600	450	0.0022	6.0	12.0	18.0	15.0	34,000	108,800,000	73TI1220(1)00(2)	R73TI1220(1)00(2)
1,600	450	0.0027	6.0	12.0	18.0	15.0	34,000	108,800,000	73TI1270(1)00(2)	R73TI1270(1)00(2)
1,600	450	0.0033	7.5	13.5	18.0	15.0	34,000	108,800,000	73TI1330(1)00(2)	R73TI1330(1)00(2)
VDC	VAC	Capacitance Value (µF)	T (mm)	H (mm)	L (mm)	Lead Spacing (S)	dV/dt (V/µs)	Max K ₀ (V ² /µs)	KEMET Internal Part Number	Customer Part Number

(1) Insert lead and packaging code. See Ordering Options Table for available options.

(2) H = 2.5%, J = 5%, K = 10%, M = 20%

Table 1 – Ratings & Part Number Reference cont.

VDC	VAC	Capacitance Value (µF)	Dimensions in mm			Lead Spacing (S)	dV/dt (V/µs)	Max K ₀ (V ² /µs)	KEMET Internal Part Number	Customer Part Number
			T	H	L					
1,600	450	0.0039	7.5	13.5	18.0	15.0	34,000	108,800,000	73TI1390(1)00(2)	R73TI1390(1)00(2)
1,600	450	0.0047	8.5	14.5	18.0	15.0	34,000	108,800,000	73TI1470(1)00(2)	R73TI1470(1)00(2)
1,600	450	0.0056	10.0	16.0	18.0	15.0	34,000	108,800,000	73TI1560(1)00(2)	R73TI1560(1)00(2)
1,600	450	0.0068	10.0	16.0	18.0	15.0	34,000	108,800,000	73TI1680(1)00(2)	R73TI1680(1)00(2)
1,600	450	0.0056	6.0	15.0	26.5	22.5	11,000	35,200,000	73TN1560(1)00(2)	R73TN1560(1)00(2)
1,600	450	0.0068	6.0	15.0	26.5	22.5	11,000	35,200,000	73TN1680(1)00(2)	R73TN1680(1)00(2)
1,600	450	0.0082	6.0	15.0	26.5	22.5	11,000	35,200,000	73TN1820(1)00(2)	R73TN1820(1)00(2)
1,600	450	0.010	6.0	15.0	26.5	22.5	11,000	35,200,000	73TN2100(1)00(2)	R73TN2100(1)00(2)
1,600	450	0.012	7.0	16.0	26.5	22.5	11,000	35,200,000	73TN2120(1)00(2)	R73TN2120(1)00(2)
1,600	450	0.015	8.5	17.0	26.5	22.5	11,000	35,200,000	73TN2150(1)00(2)	R73TN2150(1)00(2)
1,600	450	0.018	8.5	17.0	26.5	22.5	11,000	35,200,000	73TN2180(1)00(2)	R73TN2180(1)00(2)
1,600	450	0.022	10.0	18.5	26.5	22.5	11,000	35,200,000	73TN2220(1)00(2)	R73TN2220(1)00(2)
1,600	450	0.027	9.0	17.0	32.0	27.5	11,000	35,200,000	73TR2270(1)00(2)	R73TR2270(1)00(2)
1,600	450	0.033	11.0	20.0	32.0	27.5	11,000	35,200,000	73TR2330(1)00(2)	R73TR2330(1)00(2)
1,600	450	0.039	11.0	20.0	32.0	27.5	11,000	35,200,000	73TR2390(1)00(2)	R73TR2390(1)00(2)
1,600	450	0.039	24.0	15.0	32.0	27.5	11,000	35,200,000	73TR2390(1)L0(2)	R73TR2390(1)L0(2)
1,600	450	0.047	13.0	22.0	32.0	27.5	11,000	35,200,000	73TR2470(1)00(2)	R73TR2470(1)00(2)
1,600	450	0.047	24.0	15.0	32.0	27.5	11,000	35,200,000	73TR2470(1)L0(2)	R73TR2470(1)L0(2)
1,600	450	0.056	13.0	22.0	32.0	27.5	11,000	35,200,000	73TR2560(1)00(2)	R73TR2560(1)00(2)
1,600	450	0.056	24.0	15.0	32.0	27.5	11,000	35,200,000	73TR2560(1)L0(2)	R73TR2560(1)L0(2)
1,600	450	0.068	14.0	28.0	32.0	27.5	11,000	35,200,000	73TR2680(1)10(2)	R73TR2680(1)10(2)
1,600	450	0.068	24.0	15.0	32.0	27.5	11,000	35,200,000	73TR2680(1)L0(2)	R73TR2680(1)L0(2)
1,600	450	0.082	14.0	28.0	32.0	27.5	11,000	35,200,000	73TR2820(1)00(2)	R73TR2820(1)00(2)
1,600	450	0.10	18.0	33.0	32.0	27.5	11,000	35,200,000	73TR3100(1)00(2)	R73TR3100(1)00(2)
1,600	450	0.12	18.0	33.0	32.0	27.5	11,000	35,200,000	73TR3120(1)00(2)	R73TR3120(1)00(2)
1,600	450	0.15	22.0	37.0	32.0	27.5	11,000	35,200,000	73TR3150(1)00(2)	R73TR3150(1)00(2)
1,600	450	0.18	22.0	37.0	32.0	27.5	11,000	35,200,000	73TR3180(1)00(2)	R73TR3180(1)00(2)
1,600	450	0.033	11.0	22.0	41.5	37.5	6,500	20,800,000	73TW2330(1)00(2)	R73TW2330(1)00(2)
1,600	450	0.039	11.0	22.0	41.5	37.5	6,500	20,800,000	73TW2390(1)00(2)	R73TW2390(1)00(2)
1,600	450	0.047	11.0	22.0	41.5	37.5	6,500	20,800,000	73TW2470(1)00(2)	R73TW2470(1)00(2)
1,600	450	0.056	11.0	22.0	41.5	37.5	6,500	20,800,000	73TW2560(1)00(2)	R73TW2560(1)00(2)
1,600	450	0.068	11.0	22.0	41.5	37.5	6,500	20,800,000	73TW2680(1)00(2)	R73TW2680(1)00(2)
1,600	450	0.068	24.0	15.0	41.5	37.5	6,500	20,800,000	73TW2680(1)L0(2)	R73TW2680(1)L0(2)
1,600	450	0.082	11.0	22.0	41.5	37.5	6,500	20,800,000	73TW2820(1)00(2)	R73TW2820(1)00(2)
1,600	450	0.082	24.0	15.0	41.5	37.5	6,500	20,800,000	73TW2820(1)L0(2)	R73TW2820(1)L0(2)
1,600	450	0.10	13.0	24.0	41.5	37.5	6,500	20,800,000	73TW3100(1)00(2)	R73TW3100(1)00(2)
1,600	450	0.10	24.0	15.0	41.5	37.5	6,500	20,800,000	73TW3100(1)L0(2)	R73TW3100(1)L0(2)
1,600	450	0.12	16.0	28.5	41.5	37.5	6,500	20,800,000	73TW3120(1)00(2)	R73TW3120(1)00(2)
1,600	450	0.12	24.0	19.0	41.5	37.5	6,500	20,800,000	73TW3120(1)L0(2)	R73TW3120(1)L0(2)
1,600	450	0.15	16.0	28.5	41.5	37.5	6,500	20,800,000	73TW3150(1)00(2)	R73TW3150(1)00(2)
1,600	450	0.15	24.0	19.0	41.5	37.5	6,500	20,800,000	73TW3150(1)L0(2)	R73TW3150(1)L0(2)
1,600	450	0.18	16.0	28.5	41.5	37.5	6,500	20,800,000	73TW3180(1)00(2)	R73TW3180(1)00(2)
1,600	450	0.22	19.0	32.0	41.5	37.5	6,500	20,800,000	73TW3220(1)00(2)	R73TW3220(1)00(2)
1,600	450	0.27	20.0	40.0	41.5	37.5	6,500	20,800,000	73TW3270(1)00(2)	R73TW3270(1)00(2)
1,600	450	0.33	20.0	40.0	41.5	37.5	6,500	20,800,000	73TW3330(1)00(2)	R73TW3330(1)00(2)
1,600	450	0.39	24.0	44.0	41.5	37.5	6,500	20,800,000	73TW3390(1)00(2)	R73TW3390(1)00(2)
1,600	450	0.47	24.0	44.0	41.5	37.5	6,500	20,800,000	73TW3470(1)10(2)	R73TW3470(1)10(2)
1,600	450	0.47	30.0	45.0	41.5	37.5	6,500	20,800,000	73TW3470(1)00(2)	R73TW3470(1)00(2)
1,600	450	0.56	24.0	44.0	41.5	37.5	6,500	20,800,000	73TW3560(1)10(2)	R73TW3560(1)10(2)
1,600	450	0.56	30.0	45.0	41.5	37.5	6,500	20,800,000	73TW3560(1)00(2)	R73TW3560(1)00(2)
2,000	500	0.00010	5.0	11.0	18.0	15.0	54,000	216,000,000	73UI0100(1)00(2)	R73UI0100(1)00(2)
2,000	500	0.00015	5.0	11.0	18.0	15.0	54,000	216,000,000	73UI0150(1)00(2)	R73UI0150(1)00(2)
2,000	500	0.00022	5.0	11.0	18.0	15.0	54,000	216,000,000	73UI0220(1)00(2)	R73UI0220(1)00(2)
2,000	500	0.00033	5.0	11.0	18.0	15.0	54,000	216,000,000	73UI0330(1)00(2)	R73UI0330(1)00(2)
2,000	500	0.00047	5.0	11.0	18.0	15.0	54,000	216,000,000	73UI0470(1)00(2)	R73UI0470(1)00(2)
2,000	500	0.00068	5.0	11.0	18.0	15.0	54,000	216,000,000	73UI0680(1)00(2)	R73UI0680(1)00(2)
2,000	500	0.0010	6.0	12.0	18.0	15.0	54,000	216,000,000	73UI1100(1)00(2)	R73UI1100(1)00(2)
2,000	500	0.0012	6.0	12.0	18.0	15.0	54,000	216,000,000	73UI1120(1)00(2)	R73UI1120(1)00(2)
2,000	500	0.0015	7.5	13.5	18.0	15.0	54,000	216,000,000	73UI1150(1)00(2)	R73UI1150(1)00(2)
2,000	500	0.0018	7.5	13.5	18.0	15.0	54,000	216,000,000	73UI1180(1)00(2)	R73UI1180(1)00(2)
VDC	VAC	Capacitance Value (µF)	T (mm)	H (mm)	L (mm)	Lead Spacing (S)	dV/dt (V/µs)	Max K ₀ (V ² /µs)	KEMET Internal Part Number	Customer Part Number

(1) Insert lead and packaging code. See Ordering Options Table for available options.

(2) H = ±2.5% (for 2-section construction only), J = ±5%, K = ±10%.

Table 1 – Ratings & Part Number Reference cont.

VDC	VAC	Capacitance Value (µF)	Dimensions in mm			Lead Spacing (S)	dV/dt (V/µs)	Max K ₀ (V ² /µs)	KEMET Internal Part Number	Customer Part Number
			T	H	L					
2,000	500	0.0022	8.5	14.5	18.0	15.0	54,000	216,000,000	73UI1220(1)00(2)	R73UI1220(1)00(2)
2,000	500	0.0027	10.0	16.0	18.0	15.0	54,000	216,000,000	73UI1270(1)00(2)	R73UI1270(1)00(2)
2,000	500	0.0027	6.0	15.0	26.5	22.5	11,000	44,000,000	73UN1270(1)00(2)	R73UN1270(1)00(2)
2,000	500	0.0033	6.0	15.0	26.5	22.5	11,000	44,000,000	73UN1330(1)00(2)	R73UN1330(1)00(2)
2,000	500	0.0039	6.0	15.0	26.5	22.5	11,000	44,000,000	73UN1390(1)00(2)	R73UN1390(1)00(2)
2,000	500	0.0047	7.0	16.0	26.5	22.5	11,000	44,000,000	73UN1470(1)00(2)	R73UN1470(1)00(2)
2,000	500	0.0056	7.0	16.0	26.5	22.5	11,000	44,000,000	73UN1560(1)00(2)	R73UN1560(1)00(2)
2,000	500	0.0068	8.5	17.0	26.5	22.5	11,000	44,000,000	73UN1680(1)00(2)	R73UN1680(1)00(2)
2,000	500	0.0082	8.5	17.0	26.5	22.5	11,000	44,000,000	73UN1820(1)00(2)	R73UN1820(1)00(2)
2,000	500	0.010	10.0	18.5	26.5	22.5	11,000	44,000,000	73UN2100(1)00(2)	R73UN2100(1)00(2)
2,000	500	0.012	11.0	20.0	26.5	22.5	11,000	44,000,000	73UN2120(1)00(2)	R73UN2120(1)00(2)
2,000	500	0.010	9.0	17.0	32.0	27.5	11,000	44,000,000	73UR2100(1)00(2)	R73UR2100(1)00(2)
2,000	500	0.012	9.0	17.0	32.0	27.5	11,000	44,000,000	73UR2120(1)00(2)	R73UR2120(1)00(2)
2,000	500	0.012	24.0	15.0	32.0	27.5	11,000	44,000,000	73UR2120(1)L0(2)	R73UR2120(1)L0(2)
2,000	500	0.015	11.0	20.0	32.0	27.5	11,000	44,000,000	73UR2150(1)00(2)	R73UR2150(1)00(2)
2,000	500	0.015	24.0	15.0	32.0	27.5	11,000	44,000,000	73UR2150(1)L0(2)	R73UR2150(1)L0(2)
2,000	500	0.018	13.0	22.0	32.0	27.5	11,000	44,000,000	73UR2180(1)00(2)	R73UR2180(1)00(2)
2,000	500	0.018	24.0	15.0	32.0	27.5	11,000	44,000,000	73UR2180(1)L0(2)	R73UR2180(1)L0(2)
2,000	500	0.022	13.0	22.0	32.0	27.5	11,000	44,000,000	73UR2220(1)00(2)	R73UR2220(1)00(2)
2,000	500	0.027	14.0	28.0	32.0	27.5	11,000	44,000,000	73UR2270(1)10(2)	R73UR2270(1)10(2)
2,000	500	0.033	14.0	28.0	32.0	27.5	11,000	44,000,000	73UR2330(1)10(2)	R73UR2330(1)10(2)
2,000	500	0.033	18.0	33.0	32.0	27.5	11,000	44,000,000	73UR2330(1)00(2)	R73UR2330(1)00(2)
2,000	500	0.039	18.0	33.0	32.0	27.5	11,000	44,000,000	73UR2390(1)00(2)	R73UR2390(1)00(2)
2,000	500	0.047	18.0	33.0	32.0	27.5	11,000	44,000,000	73UR2470(1)00(2)	R73UR2470(1)00(2)
2,000	500	0.056	22.0	37.0	32.0	27.5	11,000	44,000,000	73UR2560(1)00(2)	R73UR2560(1)00(2)
2,000	500	0.068	22.0	37.0	32.0	27.5	11,000	44,000,000	73UR2680(1)00(2)	R73UR2680(1)00(2)
2,000	500	0.018	11.0	22.0	41.5	37.5	9,000	36,000,000	73UW2180(1)00(2)	R73UW2180(1)00(2)
2,000	500	0.018	24.0	15.0	41.5	37.5	9,000	36,000,000	73UW2180(1)L0(2)	R73UW2180(1)L0(2)
2,000	500	0.022	11.0	22.0	41.5	37.5	9,000	36,000,000	73UW2220(1)00(2)	R73UW2220(1)00(2)
2,000	500	0.022	24.0	15.0	41.5	37.5	9,000	36,000,000	73UW2220(1)L0(2)	R73UW2220(1)L0(2)
2,000	500	0.027	11.0	22.0	41.5	37.5	9,000	36,000,000	73UW2270(1)00(2)	R73UW2270(1)00(2)
2,000	500	0.027	24.0	15.0	41.5	37.5	9,000	36,000,000	73UW2270(1)L0(2)	R73UW2270(1)L0(2)
2,000	500	0.033	13.0	24.0	41.5	37.5	9,000	36,000,000	73UW2330(1)00(2)	R73UW2330(1)00(2)
2,000	500	0.033	24.0	15.0	41.5	37.5	9,000	36,000,000	73UW2330(1)L0(2)	R73UW2330(1)L0(2)
2,000	500	0.039	13.0	24.0	41.5	37.5	9,000	36,000,000	73UW2390(1)00(2)	R73UW2390(1)00(2)
2,000	500	0.039	24.0	19.0	41.5	37.5	9,000	36,000,000	73UW2390(1)L0(2)	R73UW2390(1)L0(2)
2,000	500	0.047	16.0	28.5	41.5	37.5	9,000	36,000,000	73UW2470(1)00(2)	R73UW2470(1)00(2)
2,000	500	0.056	16.0	28.5	41.5	37.5	9,000	36,000,000	73UW2560(1)00(2)	R73UW2560(1)00(2)
2,000	500	0.068	16.0	28.5	41.5	37.5	9,000	36,000,000	73UW2680(1)00(2)	R73UW2680(1)00(2)
2,000	500	0.082	19.0	32.0	41.5	37.5	9,000	36,000,000	73UW2820(1)00(2)	R73UW2820(1)00(2)
2,000	500	0.10	20.0	40.0	41.5	37.5	9,000	36,000,000	73UW3100(1)00(2)	R73UW3100(1)00(2)
2,000	500	0.12	20.0	40.0	41.5	37.5	9,000	36,000,000	73UW3120(1)00(2)	R73UW3120(1)00(2)
2,000	500	0.15	24.0	44.0	41.5	37.5	9,000	36,000,000	73UW3150(1)00(2)	R73UW3150(1)00(2)
2,000	500	0.18	30.0	45.0	41.5	37.5	9,000	36,000,000	73UW3180(1)00(2)	R73UW3180(1)00(2)
2,000	500	0.22	30.0	45.0	41.5	37.5	9,000	36,000,000	73UW3220(1)00(2)	R73UW3220(1)00(2)
VDC	VAC	Capacitance Value (µF)	T (mm)	H (mm)	L (mm)	Lead Spacing (S)	dV/dt (V/µs)	Max K ₀ (V ² /µs)	KEMET Internal Part Number	Customer Part Number

(1) Insert lead and packaging code. See Ordering Options Table for available options.

(2) H = ±2.5% (for 2-section construction only), J = ±5%, K = ±10%.

Soldering Process

The implementation of the RoHS directive has resulted in the selection of SnAgCu (SAC) alloys or SnCu alloys as a primary solder. This has increased the liquidus temperature from that of 183°C for SnPb eutectic alloy to 217 – 221°C for the new alloys. As a result, the heat stress to the components, even in wave soldering, has increased considerably due to higher pre-heat and wave temperatures. Polypropylene capacitors are especially sensitive to heat (the melting point of polypropylene is 160 – 170°C). Wave soldering can be destructive, especially for mechanically small polypropylene capacitors (with lead spacing of 5 mm to 15 mm), and great care has to be taken during soldering. The recommended solder profiles from KEMET should be used. Please consult KEMET with any questions. In general, the wave soldering curve from IEC Publication 61760–1 Edition 2 serves as a solid guideline for successful soldering. Please see Figure 1.

Reflow soldering is not recommended for through-hole film capacitors. Exposing capacitors to a soldering profile in excess of the above recommended limits may result in degradation or permanent damage to the capacitors.

Do not place the polypropylene capacitor through an adhesive curing oven to cure resin for surface mount components. Insert through-hole parts after the curing of surface mount parts. Consult KEMET to discuss the actual temperature profile in the oven, if through-hole components must pass through the adhesive curing process. A maximum two soldering cycles is recommended. Please allow time for the capacitor surface temperature to return to a normal temperature before the second soldering cycle.

Manual Soldering Recommendations

The following is recommended for manual soldering with a soldering iron.

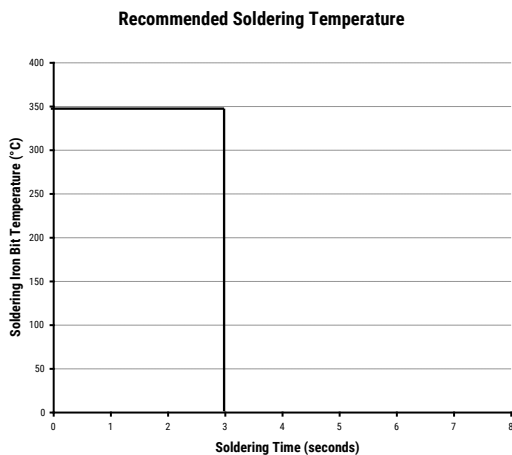

The soldering iron tip temperature should be set at 350°C (+10°C maximum) with the soldering duration not to exceed more than 3 seconds.

Wave Soldering Recommendations

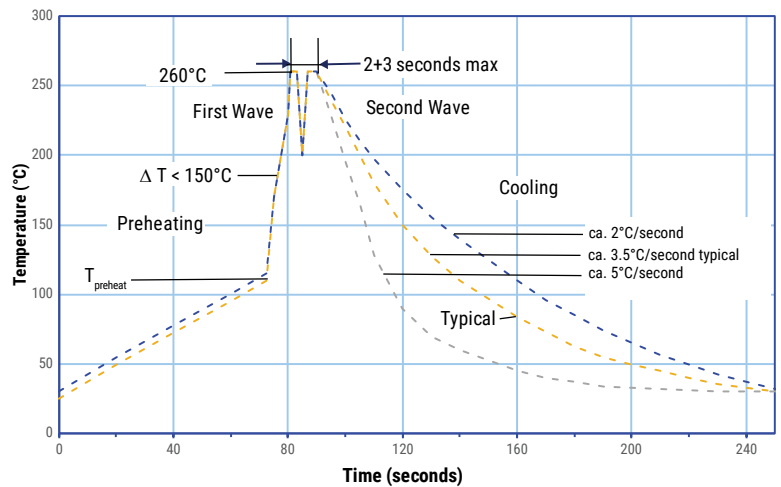

Soldering Process cont.

Wave Soldering Recommendations cont.

1. The table indicates the maximum set-up temperature of the soldering process
Figure 1.

Dielectric Film Material	Maximum Preheat Temperature		Maximum Peak Soldering Temperature	
	Capacitor Pitch ≤ 15 mm	Capacitor Pitch > 15 mm	Capacitor Pitch ≤ 15 mm	Capacitor Pitch > 15 mm
Polyester	130°C	130°C	270°C	270°C
Polypropylene	110°C	130°C	260°C	270°C
Paper	130°C	140°C	270°C	270°C
Polyphenylene Sulphide	150°C	160°C	270°C	270°C

2. The maximum temperature measured inside the capacitor:

Set the temperature so that inside the element the maximum temperature is below the limit:

Dielectric Film Material	Maximum temperature measured inside the element
Polyester	160°C
Polypropylene	110°C
Paper	160°C
Polyphenylene Sulphide	160°C

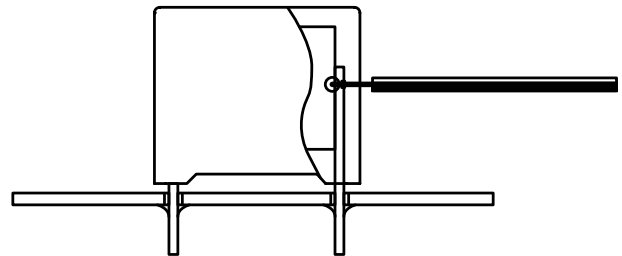

Temperature monitored inside the capacitor.

Selective Soldering Recommendations

Selective dip soldering is a variation of reflow soldering. In this method, the printed circuit board with through-hole components to be soldered is preheated and transported over the solder bath as in normal flow soldering without touching the solder. When the board is over the bath, it is stopped and pre-designed solder pots are lifted from the bath with molten solder only at the places of the selected components, and pressed against the lower surface of the board to solder the components.

The temperature profile for selective soldering is similar to the double wave flow soldering outlined in this document, **however, instead of two baths, there is only one bath with a time from 3 to 10 seconds.** In selective soldering, the risk of overheating is greater than in double wave flow soldering. Great care must be taken so that the parts are not overheated.

Construction

1 Section

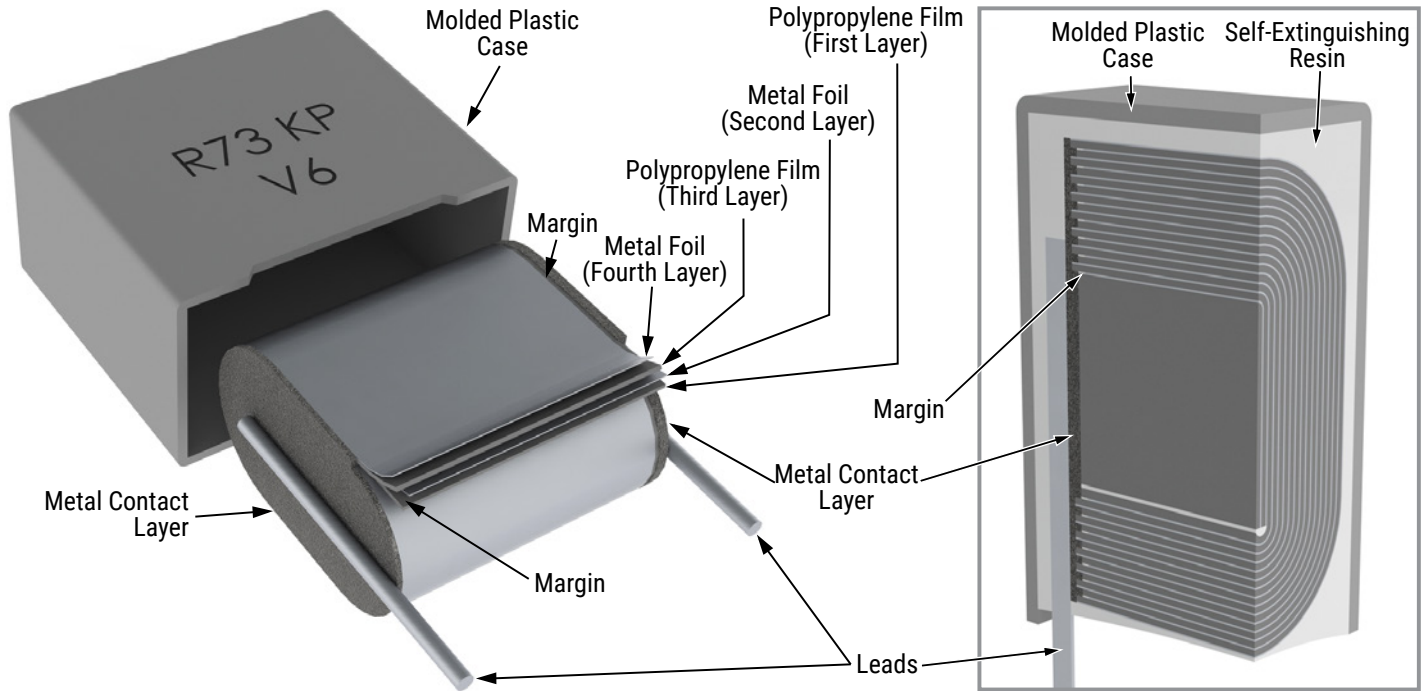

Winding Schemes

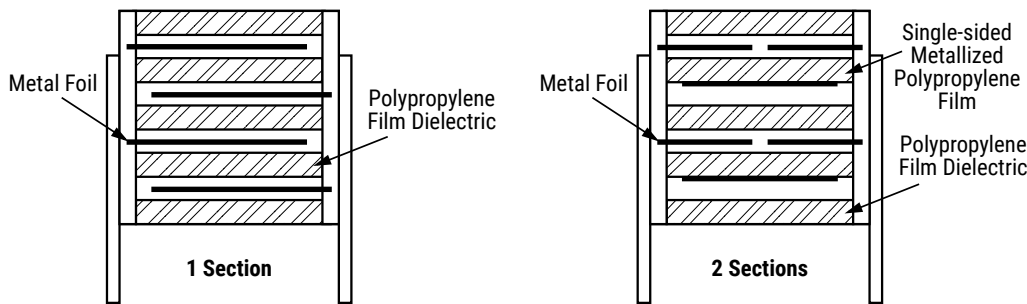

Marking

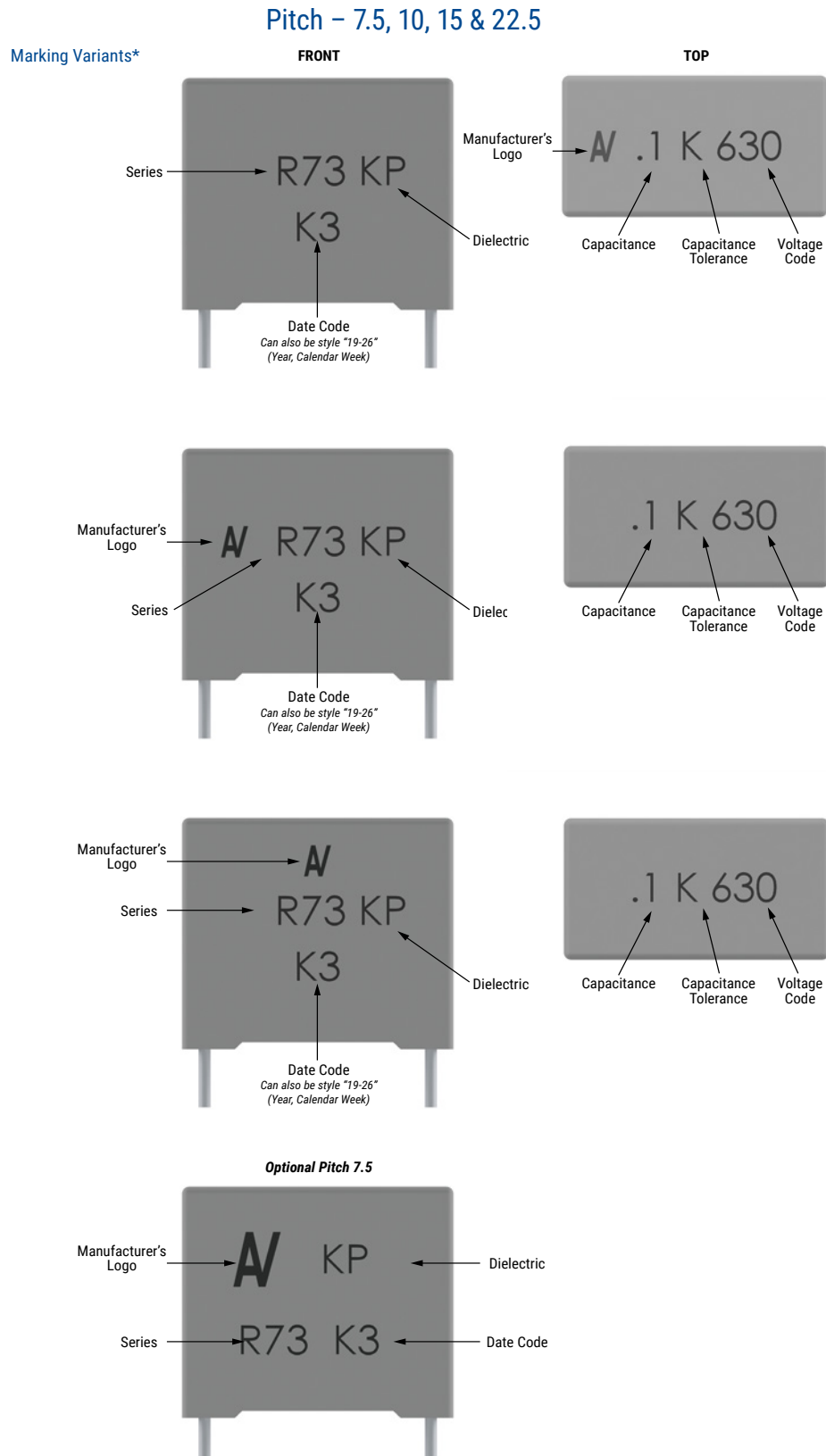

* Differences are caused by technology (clichee, laser or ink jet) and technic (production line).

Marking cont.

Pitch – 7.5, 10, 15, 22.5, 27.5 & 37.5

Marking Variants*

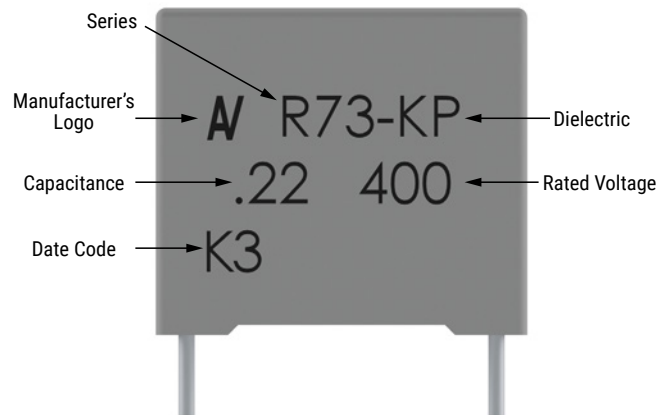
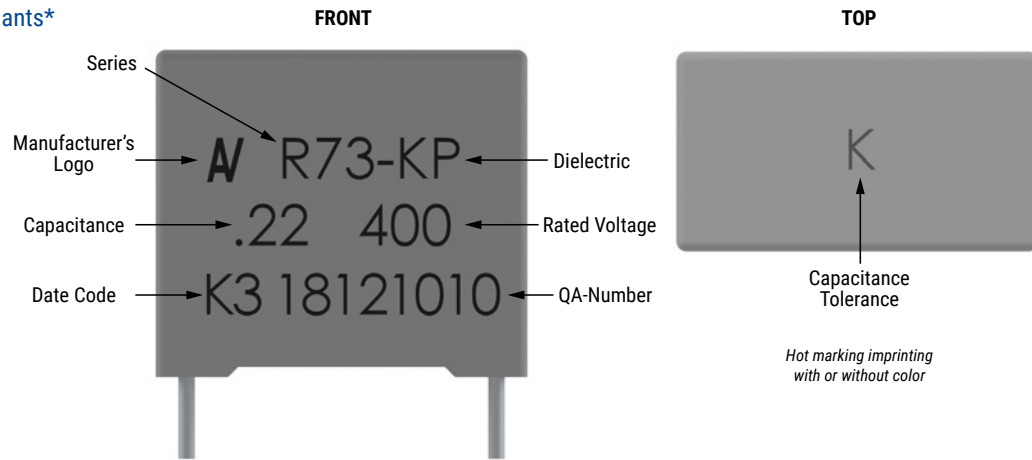

Pitch – 22.5, 27.5 & 37.5

Marking Variants*

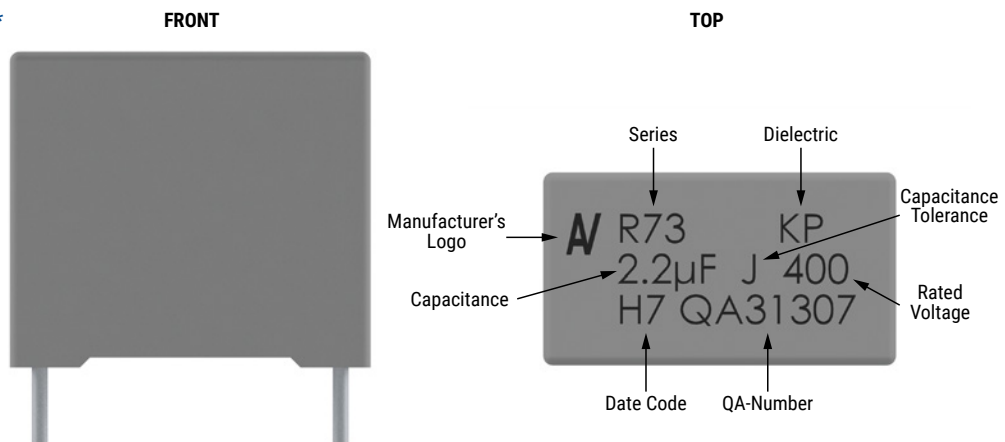

* Differences are caused by technology (clichee, laser or ink jet) and technic (production line).

Marking cont.

Manufacturing Date Code (IEC-60062)			
Year	Code	Month	Code
2020	M	January	1
2021	N	February	2
2022	P	March	3
2023	R	April	4
2024	S	May	5
2025	T	June	6
2026	U	July	7
2027	V	August	8
2028	W	September	9
2029	X	October	0
2030	A	November	N
2031	B	December	D
2032	C		
2033	D		
2034	E		
2035	F		
2036	H		
2037	J		
2038	K		
2039	L		
2040	M		

Packaging Quantities

Lead Spacing	Thickness (mm)	Height (mm)	Length (mm)	Bulk Short Leads	Bulk Long Leads		Standard Reel ø 355 mm	Large Reel ø 500 mm	Ammo Taped
	Lead and Packaging Code			JB - JE JH - SE	JM	40 - 50	GY	CK	DQ
10	4.0	9.0	13.0	2,000	2,200	1,800	750	1,500	1,000
	5.0	11.0	13.0	1,300	2,000	1,500	600	1,250	800
	6.0	12.0	13.0	1,000	1,800	1,200	500	1,000	680
15	5.0	11.0	18.0	2,000	1,250	1,000	600	1,250	800
	6.0	12.0	18.0	1,750	1,000	900	500	1,000	680
	7.5	13.5	18.0	1,000	800	700	350	800	500
	8.5	14.5	18.0	1,000	650	500	300	700	440
	9.0	12.5	18.0	1,000	700	520	270	650	410
	10.0	16.0	18.0	750	550	500	270	600	380
	11.0	19.0	18.0	450	400	350	270	500	340
22.5	6.0	15.0	26.5	805	450	500	300	700	464
	7.0	16.0	26.5	700	450	500	250	550	380
	8.5	17.0	26.5	468	350	300	250	450	280
	10.0	18.5	26.5	396	350	300	160	350	235
	11.0	20.0	26.5	360	200	250	160	350	217
27.5	13.0	22.0	26.5	300	150	200	130	300	-
	9.0	17.0	32.0	816	-	408	230	450	-
	11.0	20.0	32.0	560	-	336	190	350	-
	13.0	12.0	32.0	672	-	288	-	-	-
	13.0	22.0	32.0	480	-	288	150	300	-
	13.0	25.0	32.0	480	-	288	-	-	-
	14.0	28.0	32.0	352	-	176	-	-	-
	18.0	33.0	32.0	256	-	128	-	-	-
37.5	22.0	37.0	32.0	168	-	112	-	-	-
	24.0	15.0	32.0	336	-	144	-	-	-
	11.0	22.0	41.5	420	-	252	-	-	-
	13.0	24.0	41.5	360	-	216	-	-	-
	16.0	28.5	41.5	216	-	108	-	-	-
	19.0	32.0	41.5	192	-	96	-	-	-
	20.0	40.0	41.5	126	-	84	-	-	-
	24.0	15.0	41.5	252	-	108	-	-	-
	24.0	19.0	41.5	216	-	108	-	-	-
24.0	44.0	41.5	108	-	72	-	-	-	
30.0	45.0	41.5	90	-	60	-	-	-	

Lead Taping & Packaging (IEC 60286-2)

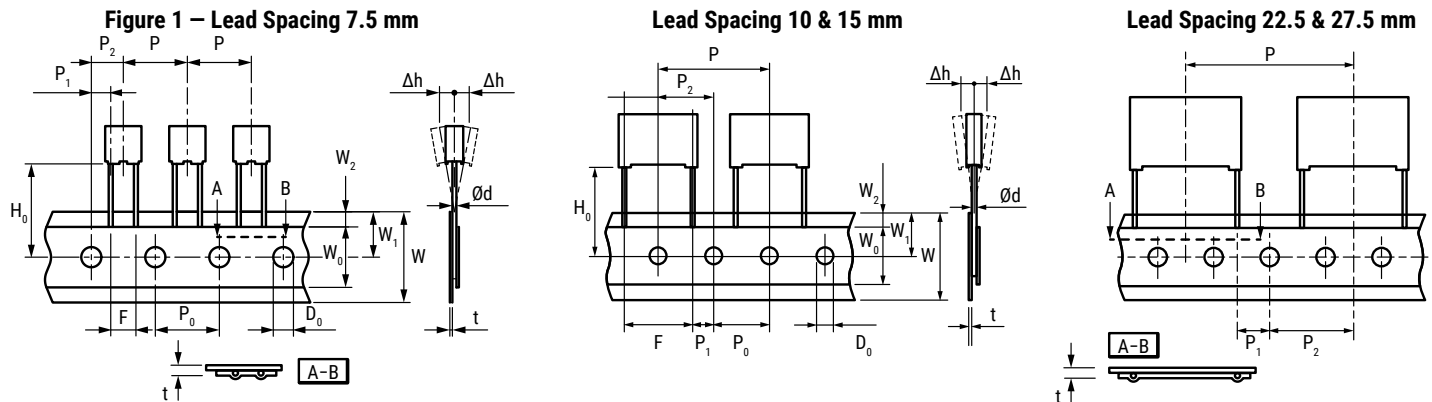

Taping Specification

Description	Symbol	Dimensions (mm)					Tolerance
		Lead Spacing					
		7.5 Figure 1	10.0 Figure 2	15.0 Figure 2	22.5 Figure 3	27.5 Figure 3	
Lead wire diameter	d	0.5 – 0.6	0.6	0.6 – 0.8	0.8	0.8	±0.05
Taping lead space	P	12.7	25.4	25.4	38.1	38.1	±1
Feed hole lead space *	P ₀	12.7	12.7	12.7	12.7	12.7	±0.2 **
Centering of the lead wire	P ₁	2.6	7.7	5.2	7.8	5.3	±0.7
Centering of the body	P ₂	6.35	12.7	12.7	19.05	19.05	±1.3
Lead spacing ***	F	7.5	10.0	15.0	22.5	27.5	+0.6/-0.1
Component alignment	Δh	0	0	0	0	0	±2
Component deviation	Δp	0	0	0	0	0	±1
Height of component from tape center	H ₀ ****	18.5	18.5	18.5	18.5	18.5	±0.5
Carrier tape width	W	18	18	18	18	18	+1/-0.5
Hold down tape width	W ₀	6	9	10	10	10	Minimum
Hole position	W ₁	9	9	9	9	9	±0.5
Hold down tape position	W ₂	3	3	3	3	3	Maximum
Feed hole diameter	D ₀	4	4	4	4	4	±0.2
Total tape thickness	t	0.7	0.7	0.7	0.7	0.7	±0.2

* Available also 15 mm.

** Maximum 1 mm on 20 lead spacing.

*** 15 mm and 10 mm taped to 7.5 mm (crimped leads) available upon request.

**** H₀ = 16.5 mm is available upon request.

Lead Taping & Packaging (IEC 60286-2) cont.

Ammo Specifications

Dimensions (mm)		
H	W	T
360	340	59

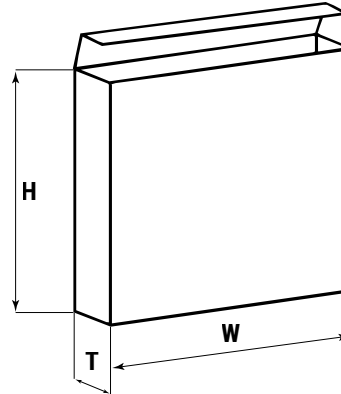

Reel Specifications

Dimensions (mm)		
D	H	W
355	30	55 Maximum
500	25	

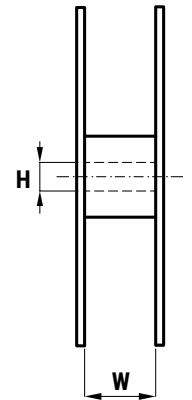
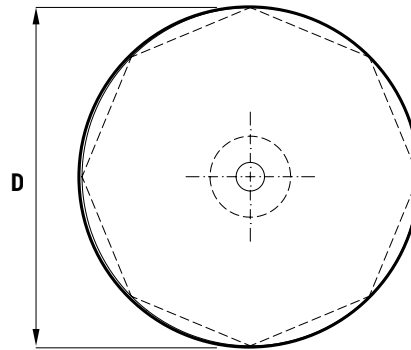

KEMET Electronics Corporation Sales Offices

For a complete list of our global sales offices, please visit www.kemet.com/sales.

Disclaimer

YAGEO Corporation and its affiliates do not recommend the use of commercial or automotive grade products for high reliability applications or manned space flight.

All product specifications, statements, information and data (collectively, the "Information") in this datasheet are subject to change. The customer is responsible for checking and verifying the extent to which the Information contained in this publication is applicable to an order at the time the order is placed. All Information given herein is believed to be accurate and reliable, but it is presented without guarantee, warranty, or responsibility of any kind, expressed or implied.

Statements of suitability for certain applications are based on KEMET Electronics Corporation's ("KEMET") knowledge of typical operating conditions for such applications, but are not intended to constitute – and KEMET specifically disclaims – any warranty concerning suitability for a specific customer application or use. The Information is intended for use only by customers who have the requisite experience and capability to determine the correct products for their application. Any technical advice inferred from this Information or otherwise provided by KEMET with reference to the use of KEMET's products is given gratis, and KEMET assumes no obligation or liability for the advice given or results obtained.

Although KEMET designs and manufactures its products to the most stringent quality and safety standards, given the current state of the art, isolated component failures may still occur. Accordingly, customer applications which require a high degree of reliability or safety should employ suitable designs or other safeguards (such as installation of protective circuitry or redundancies) in order to ensure that the failure of an electrical component does not result in a risk of personal injury or property damage.

Although all product-related warnings, cautions and notes must be observed, the customer should not assume that all safety measures are indicated or that other measures may not be required.

Additional information about production site flexibility can be found [here](#)

KEMET is a registered trademark of KEMET Electronics Corporation.