

934443502 ✓ ACTIVE

DEUTSCH | Deutsch DT-XT

TE Internal #: 2-2600030-0

Deutsch DT-XT, Receptacle, Wire-to-Wire, 4 Position, 4.5mm [.177in] Centerline, Sealable, Gray, Wire & Cable, Cable Mount (Free-Hanging)

[View on TE.com >](#)



Connectors > Automotive Connectors > Connector Housings

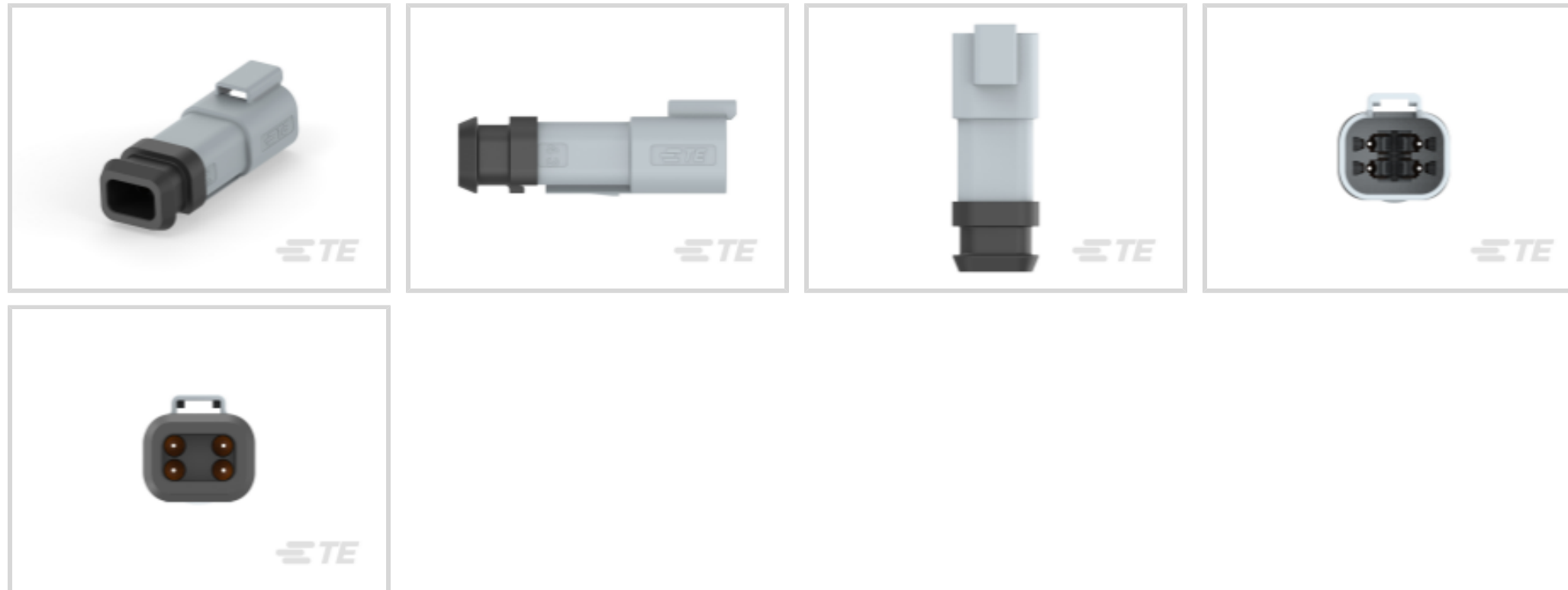

Connector & Housing Type: **Receptacle**

Mating Pin Diameter: **1.56 mm [.061 in]**

Connector System: **Wire-to-Wire**

Number of Positions: **4**

Centerline (Pitch): **4.5 mm [.177 in]**

Features

Product Type Features

Connector & Housing Type	Receptacle
Connector System	Wire-to-Wire
Sealable	Yes
Hybrid Connector	No
Primary Locking Feature	Integrated in Housing
Connector & Contact Terminates To	Wire & Cable

Configuration Features

Number of Positions	4
Number of Rows	2

Body Features

Primary Product Color	Gray
-----------------------	------

Contact Features

Mating Pin Diameter	1.56 mm[.061 in]
---------------------	------------------



Mechanical Attachment

Connector Mounting Type	Cable Mount (Free-Hanging)
-------------------------	----------------------------

Housing Features

Centerline (Pitch)	4.5 mm [.177 in]
--------------------	------------------

Usage Conditions

Operating Temperature (Max)	125 °C [257 °F]
Operating Temperature Range	-55 – 125 °C [-67 – 257 °F]

Other

Connector Position Assurance Capable	No
--------------------------------------	----

Product Compliance

[For compliance documentation, visit the product page on TE.com>](#)

EU RoHS Directive 2011/65/EU	Compliant
EU ELV Directive 2000/53/EC	Compliant
China RoHS 2 Directive MIIT Order No 32, 2016	No Restricted Materials Above Threshold
EU REACH Regulation (EC) No. 1907/2006	Current ECHA Candidate List: JUL 2021 (219) Candidate List Declared Against: JAN 2021 (211) SVHC > Threshold: Not Yet Reviewed
Halogen Content	Low Halogen - Br, Cl, F, I < 900 ppm per homogenous material. Also BFR/CFR/PVC Free
Solder Process Capability	Not reviewed for solder process capability

Product Compliance Disclaimer

This information is provided based on reasonable inquiry of our suppliers and represents our current actual knowledge based on the information they provided. This information is subject to change. The part numbers that TE has identified as EU RoHS compliant have a maximum concentration of 0.1% by weight in homogenous materials for lead, hexavalent chromium, mercury, PBB, PBDE, DBP, BBP, DEHP, DIBP, and 0.01% for cadmium, or qualify for an exemption to these limits as defined in the Annexes of Directive 2011/65/EU (RoHS2). Finished electrical and electronic equipment products will be CE marked as required by Directive 2011/65/EU. Components may not be CE marked. Additionally, the part numbers that TE has identified as EU ELV compliant have a maximum concentration of 0.1% by weight in homogenous materials for lead, hexavalent chromium, and mercury, and 0.01% for cadmium, or qualify for an exemption to these limits as defined in the Annexes of Directive 2000/53/EC (ELV). Regarding the REACH Regulation, the information TE provides on SVHC in articles for this part number is based on the latest European Chemicals Agency (ECHA) 'Guidance on requirements for substances in articles' posted at this URL: <https://echa.europa.eu/guidance-documents/guidance-on-reach>

Compatible Parts



Also in the Series | Deutsch DT-XT

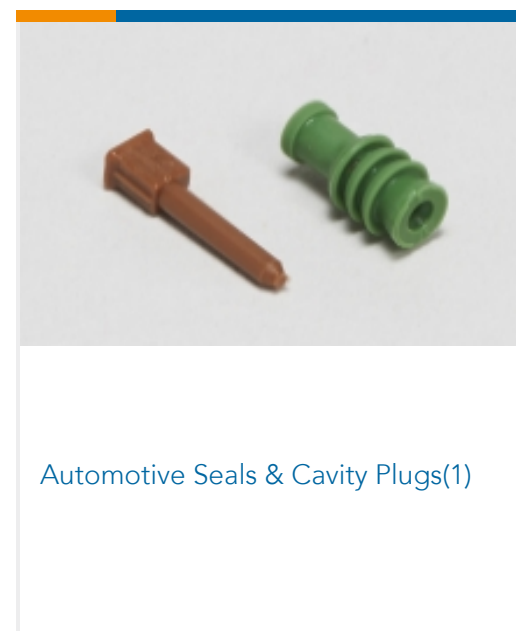
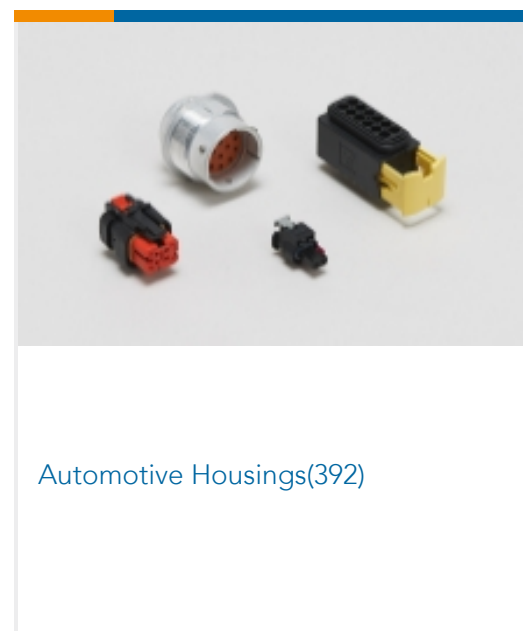

Customers Also Bought

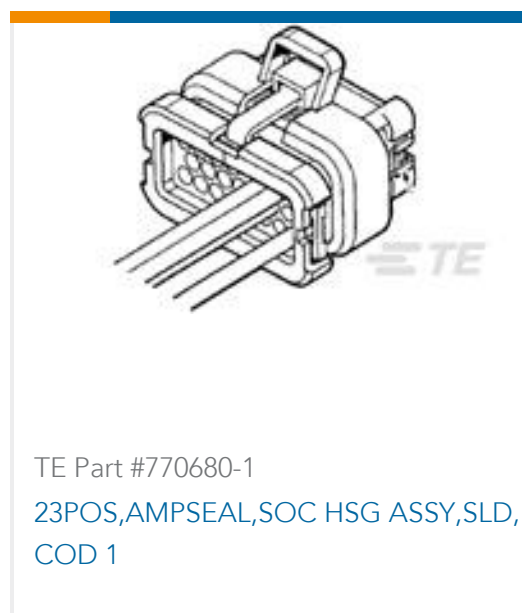

Documents

[CAD Files](#)

[3D PDF](#)

[3D](#)

[Customer View Model](#)

[ENG_CVM_CVM_2-2600030-0_1.2d_dxf.zip](#)

English



Customer View Model

[ENG_CVM_CVM_2-2600030-0_1.3d_igs.zip](#)

English

Customer View Model

[ENG_CVM_CVM_2-2600030-0_1.3d_stp.zip](#)

English

By downloading the CAD file I accept and agree to the [Terms and Conditions](#) of use.

Product Specifications

[Application Specification](#)

English