

# SMC

## 1.27 mm Connectors

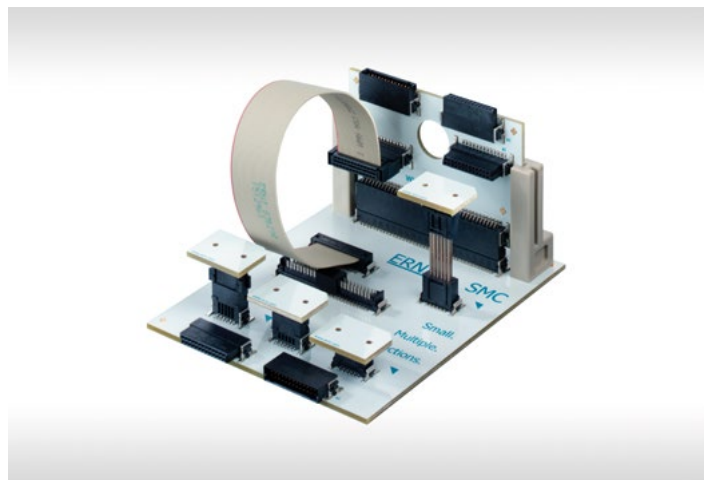
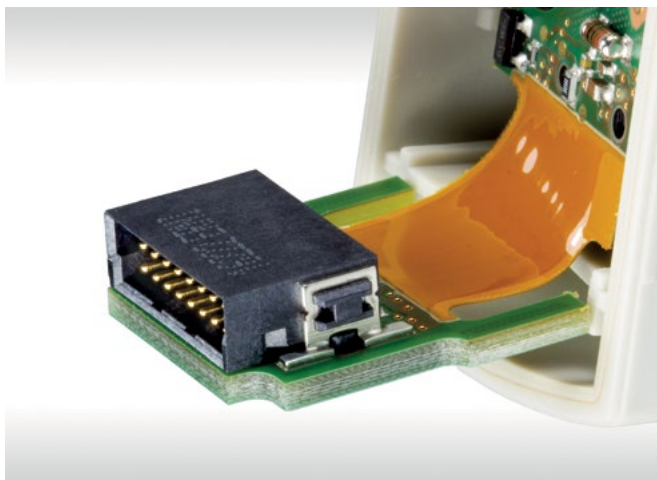
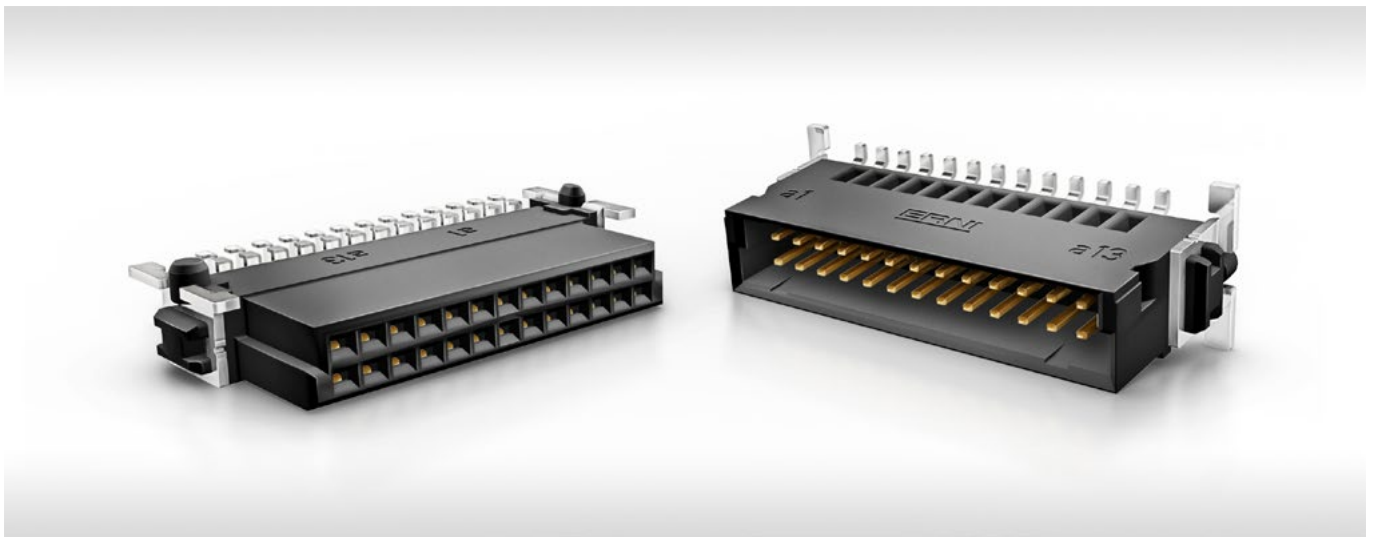

---

# SMC - SMALL GRID, BIG POSSIBILITIES

Limited space and high performance demands are characteristics of many modern electronic systems, all of which the connectors must accommodate. There is a corresponding demand for compact, secure, and reliable connectors, with high signal integrity and a relatively high current-carrying capacity.

The comprehensive SMC range helps meet these requirements. The high-performance SMT connectors come in a number of different designs, heights, and contact densities in a 1.27 mm grid.

The basic design criteria for the SMC series include double-sided spring contacts for top-rate contact properties and maximum contact reliability, a high-temperature resistant insulator with polarization and insertion chamfers, and a very high mating reliability.

The contact design exhibits a virtually continuous impedance profile and enables secure data transmission rates of up to 3 Gbit/s (differential) if the system is suitably designed.

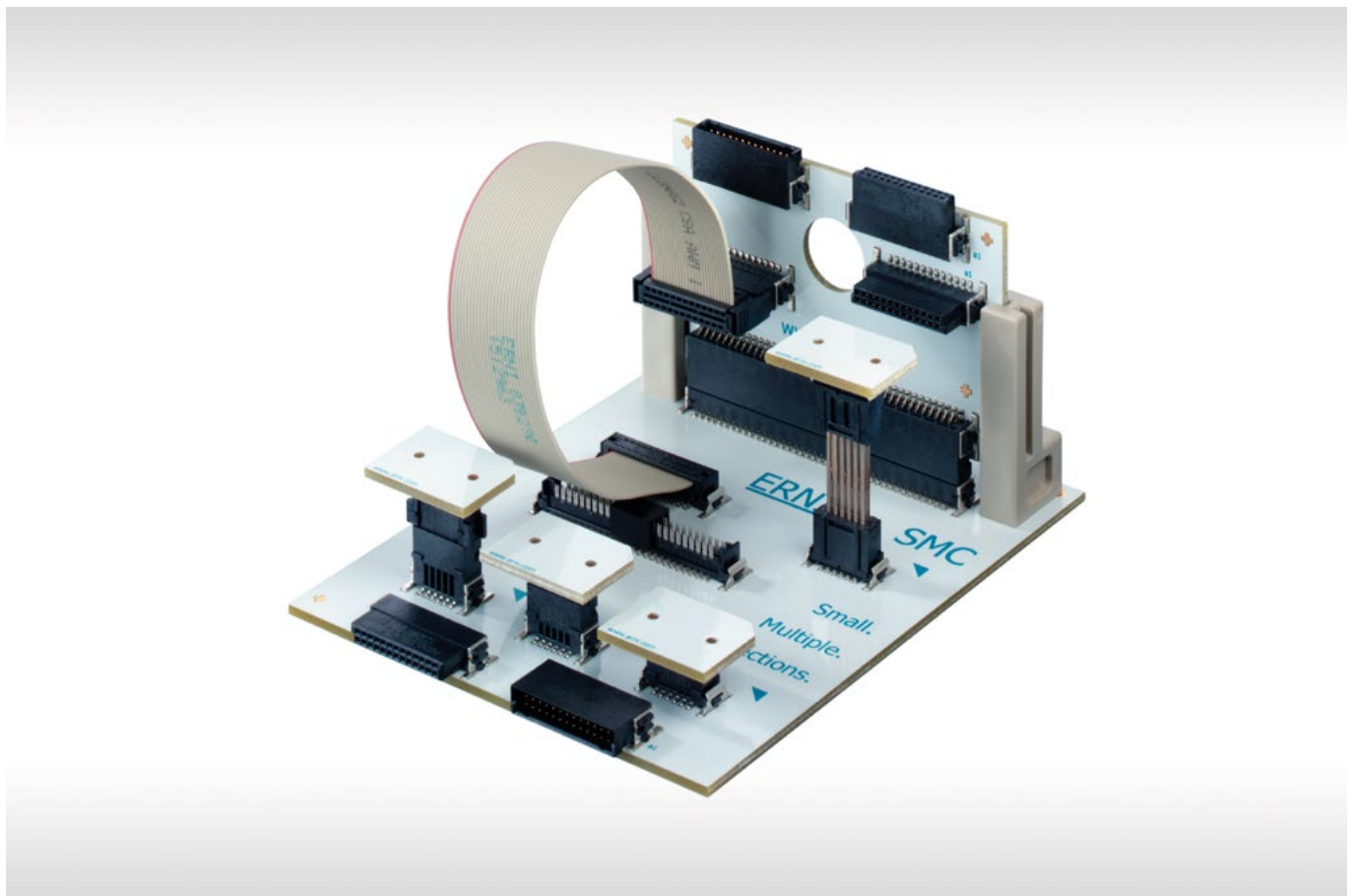

# FEATURES

Pitch	1.27 mm
No. of Pins	12, 16, 20, 26, 32, 40, 50, 68, 80
Termination technology	SMT, individual variants in pressfit technology
Applications	<p>Data rate up to 3 Gbit/s</p> <p>Current rating up to 1.7 A per contact</p> <p>Board-to-Board connections:</p> <ul style="list-style-type: none"> <li>- stacked (Mezzanine)</li> <li>- orthogonal</li> <li>- coplanar</li> </ul> <p>Wire-to-Board connections (ribbon cable):</p> <ul style="list-style-type: none"> <li>- pluggable</li> <li>- permanent</li> </ul>
Variants	<p>Male connectors, vertical and right angle</p> <p>Female connectors, vertical and right angle</p> <p>Board-to-Board adapter</p> <p>Board-on IDC</p> <p>Cable assembly:</p> <ul style="list-style-type: none"> <li>- Female connectors IDC, right angle</li> </ul>
Special versions	<p>Lockable connectors</p> <p>Pressfit male connectors</p> <p>Reduced locating pegs / without pegs</p> <p>First mate/early break contacts</p>

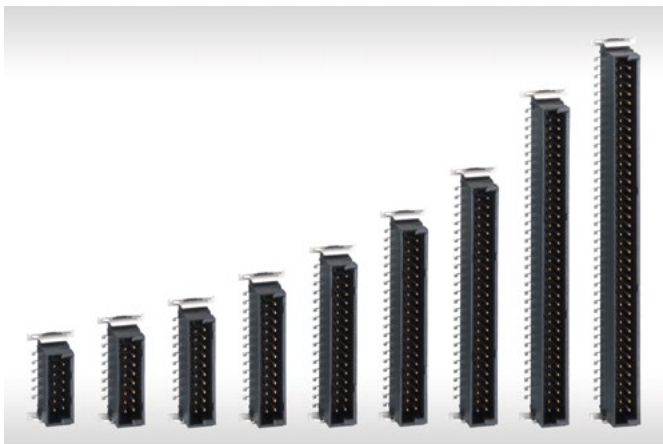

# CAPABILITIES



Stacked boards (Mezzanine)



Board-to-Board adapter: enhanced board-to-Board heights

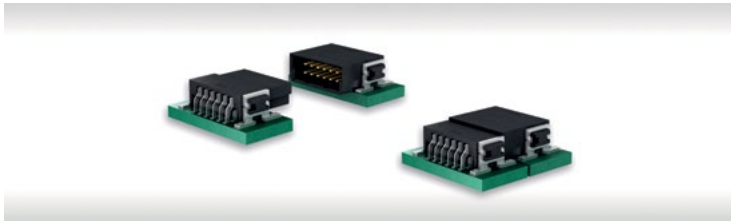

Extender card (coplanar)

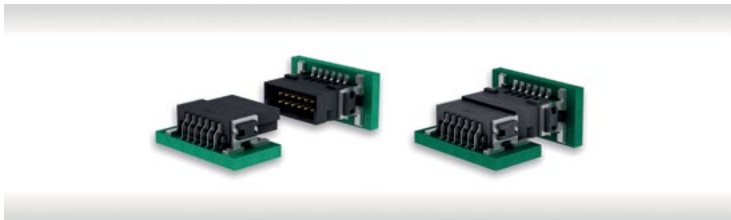

Orthogonal boards

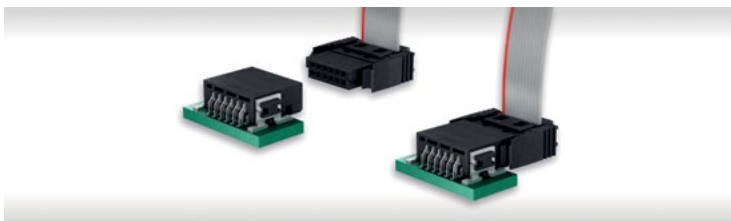

Wire-to-Board (pluggable)

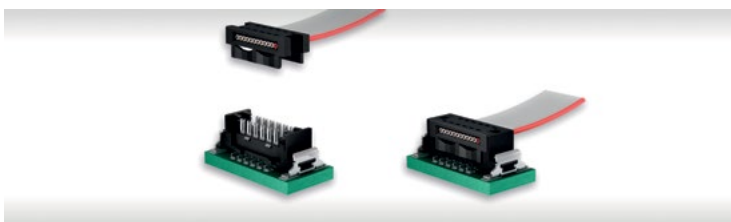

Wire-to-Board (permanent): Board-on IDC

---

# ADVANTAGES

## High Reliable Contact Design

- reliable, dual-beam female contact
- twisted contact tulip (90°)
- rolled, homogeneous surface, provides for more secure contact mating
- wide contact surfaces between the mated pairs
- extremely low surface roughness significantly reduces abrasion
- low contact resistance



## Polarization / Mating Face

- mating face polarization guards against mismating and incorrect connection
- more secure mating due to insertion chamfers in the capture range
- distinctive guide elements for precise insertion

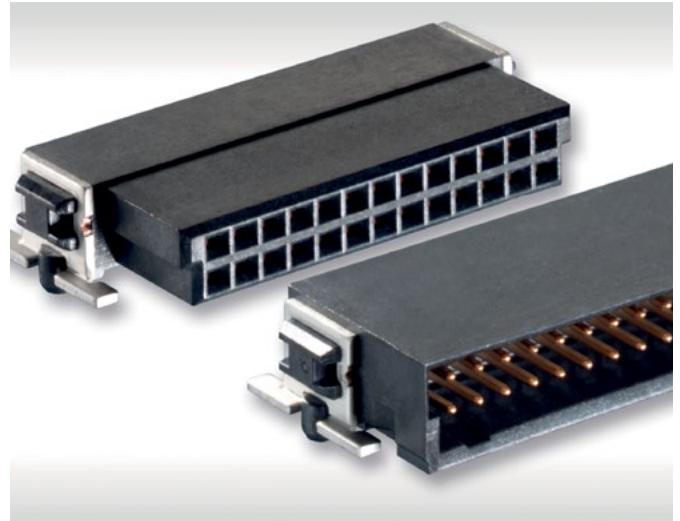

## Robust Solder Clips

- outstanding retention forces on the circuit board
- soldering brackets absorb mechanical stress and are able to withstand high shock and vibration loads
- documented shear and tear-off forces build trust in surface-mounted connectors (e.g., shear force: min. 1000 N; tear-off force: min. 100 N)

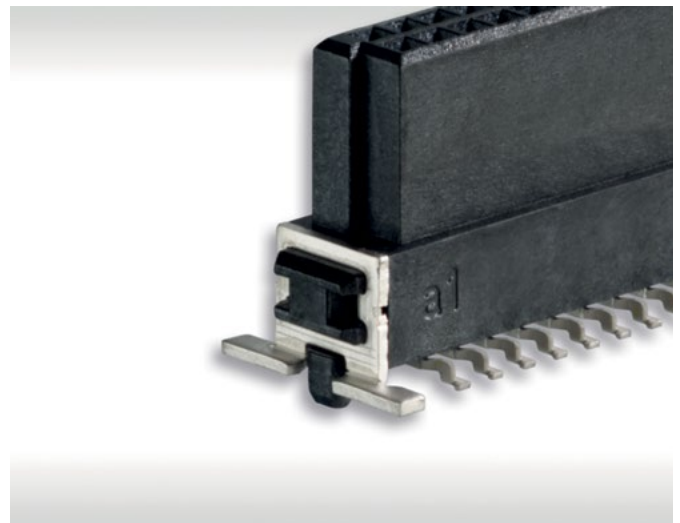

---

# ADVANTAGES

## Interlocking Snap-In

- lockable printed circuit board (PCB) and cable connectors
- secured against heavy vibration and shock loads
- snap-in: locking when mating; can only be released with tools
- cable connector: integrated locking lever; can be manually released without tools
- protection against accidental release of Wire-to-Board connections
- cable guide provides for strain relief

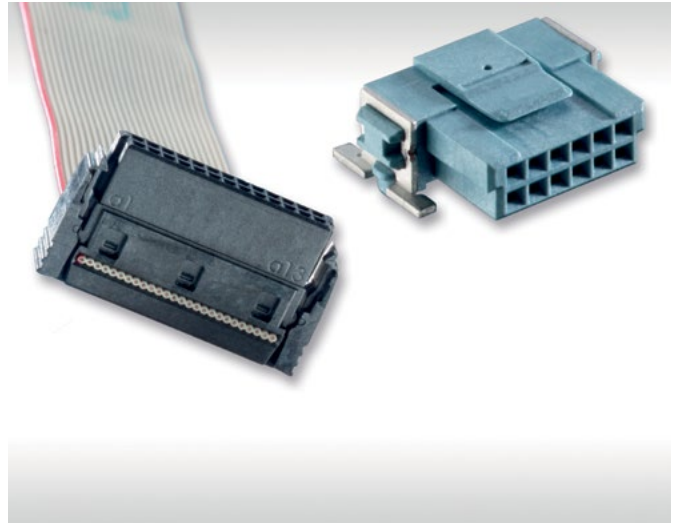

## Snap-In B-to-B Adapter

- single-sided locking of Board-to-Board adapters on low-profile female connectors
- enables the mating and release of two boards always on one specified side



## Locating Pegs

- geometrically heterogeneous locating pegs for precise positioning on the circuit board
- enables excellent compensation of PCB holes for both positive and negative tolerances

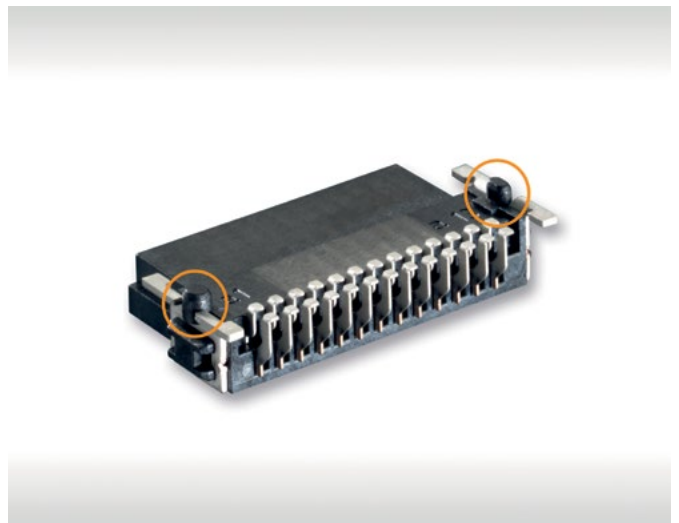

---

# PROCESSING

## Tape and Reel Packaging

- transport safe packaging
- automatic assembly



## Automatic Assembly and Reflow Soldering

- for efficient processing on modern assembly lines

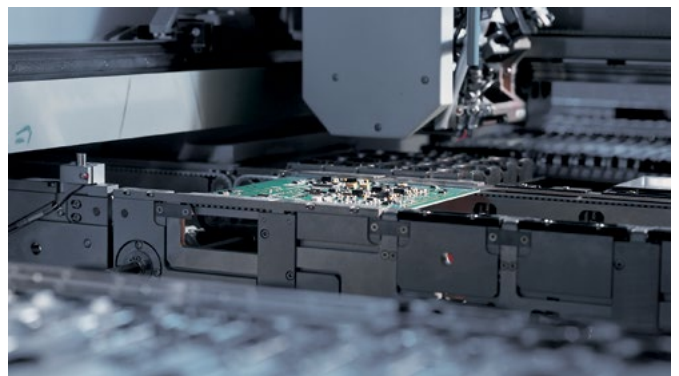

## Backside Reflow Soldering

- capable of two sided reflow soldering



## Permanent Wire-to-Board Connection (Board-on IDC)

- automated and cost-efficient assembly of ribbon cables

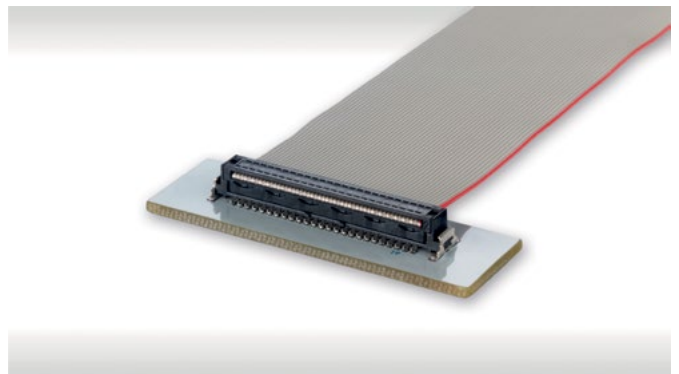

# BOARD-ON IDC

## Automated Assembly

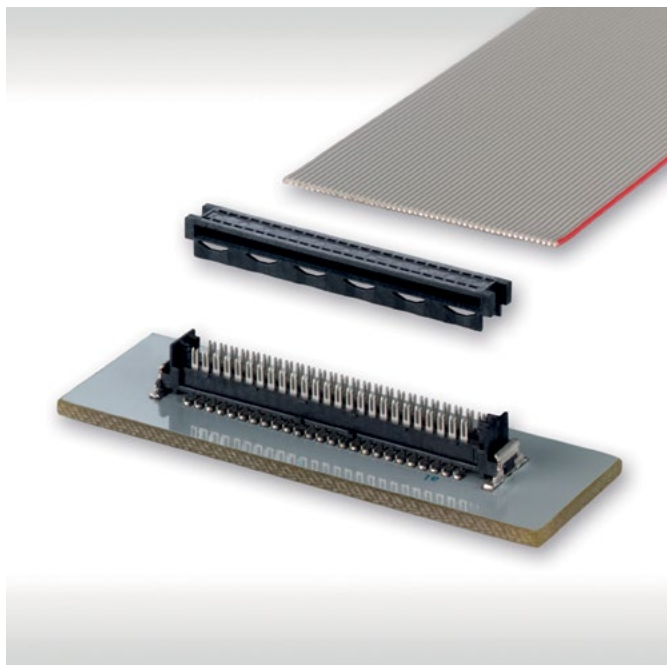

## Feeding of the Ribbon Cable and Cable Guide

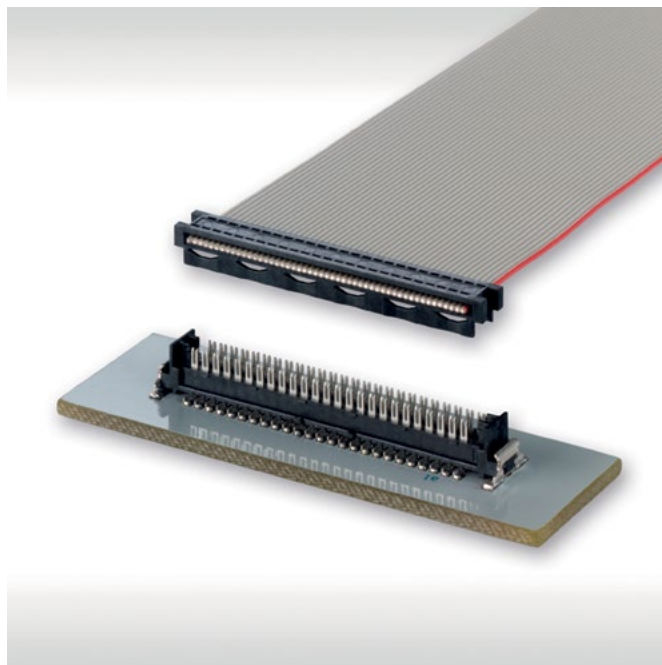

## Press-in without Special Tool

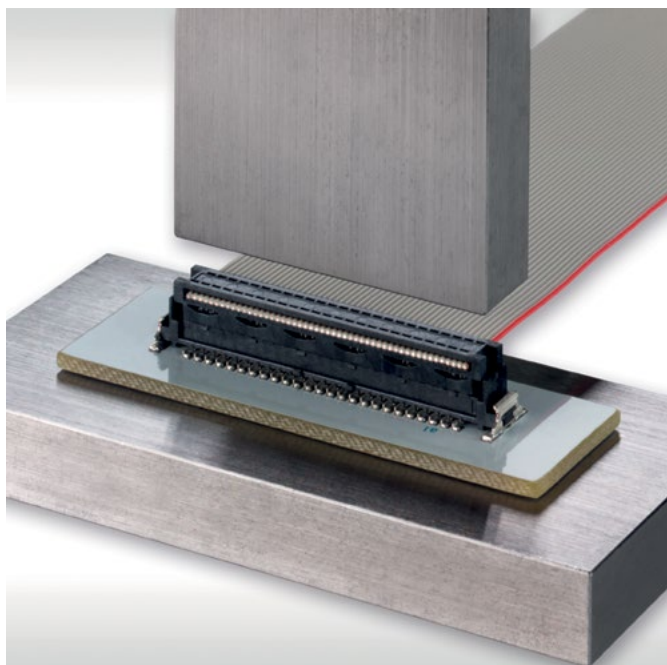

## Processed Connection

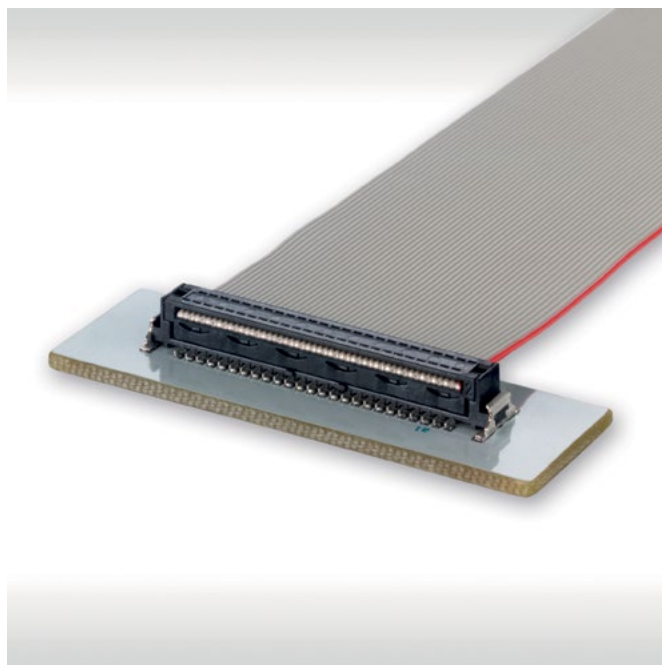



# MATING CONDITIONS

## Allowed Inclination for a more Secure Self-Centering

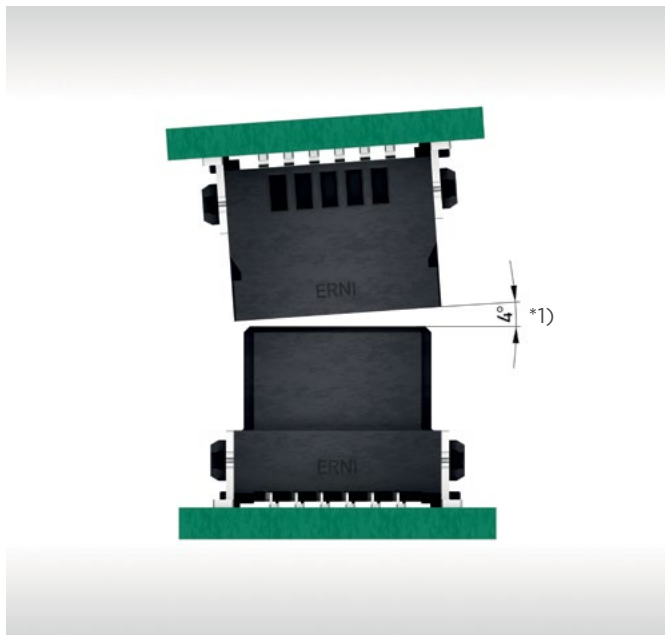

\*1) depends on no. of pins and misalignment tolerance

## Allowed Misalignment Tolerances for a more Secure Self-Centering

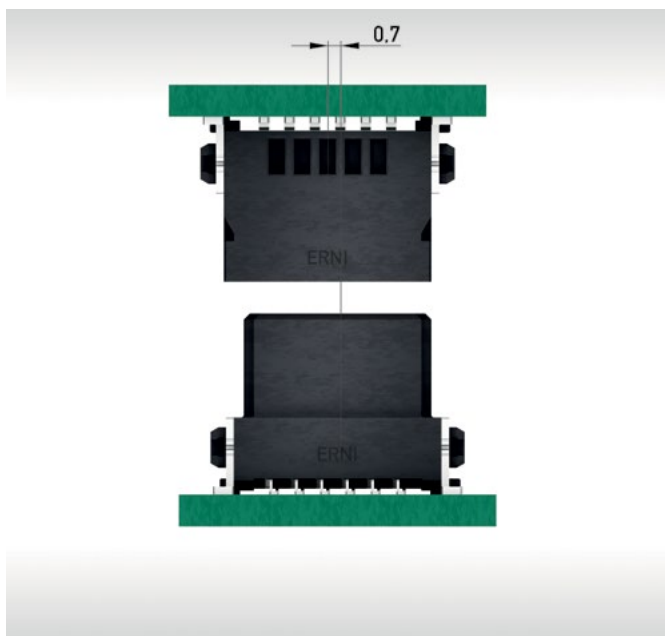

# BOARD-TO-BOARD HEIGHT

## Stacked Boards / Mezzanine

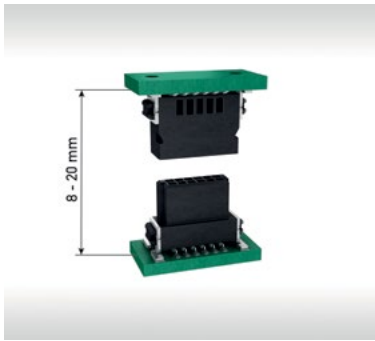

Board-to-Board Height	Male Stacking Height	Female Stacking Height
8.00 - 9.50 mm	1.75 mm	6.25 mm
9.50 - 11.00 mm	3.25 mm	6.25 mm
10.80 - 12.30 mm	1.75 mm	9.05 mm
12.30 - 13.80 mm	3.25 mm	9.05 mm
13.90 - 15.40 mm	4.85 mm	9.05 mm
15.40 - 16.90 mm	1.75 mm	13.65 mm
16.90 - 18.40 mm	3.25 mm	13.65 mm
18.50 - 20.00 mm	4.85 mm	13.65 mm

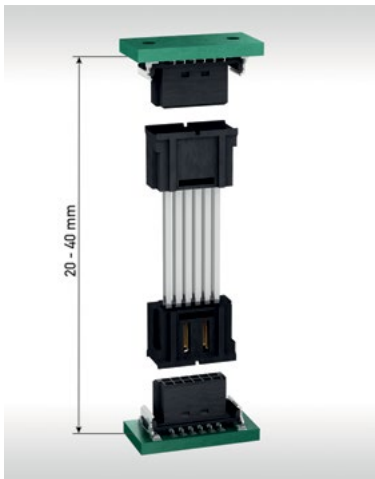

Board-to-Board Height	Board-to-Board Adapter	Female Stacking Height
20 mm	20 mm	2 x 6.25 mm
22 mm	22 mm	2 x 6.25 mm
24 mm	24 mm	2 x 6.25 mm
26 mm	26 mm	2 x 6.25 mm
28 mm	28 mm	2 x 6.25 mm
30 mm	30 mm	2 x 6.25 mm
32 mm	32 mm	2 x 6.25 mm
34 mm	34 mm	2 x 6.25 mm
36 mm	36 mm	2 x 6.25 mm
38 mm	38 mm	2 x 6.25 mm
40 mm	38 mm (wipe length)	2 x 6.25 mm

# ELECTRICAL AND MECHANICAL CHARACTERISTICS

## Technical Data

Description	Standard	PCB Connectors, Cable Assemblies, B-to-B Adapter	Board-on IDC (Ribbon Cable AWG 30, 250 mm)
Climate category	DIN EN 60068-1 test b	55 / 150 / 56	55 / 125 / 56
Temperature range		-55 / 125 °C (PCB Connectors) -55 / 125 °C (TPE-S Cable)	-55 / 125 °C (TPE-S Cable)
Current rating per contact	IEC60512 test 5b	12-pin version at 20 °C ambient temperature: 1.7 A (up to 2.7 A with optimized layout)	
Air- and creepage distance		contact - contact min. 0.4 mm	
Operating voltage	IEC 60664	The permissible operating voltages depend on the customer application and on the applicable or specified safety requirements. Insulation coordination according to IEC 60664-1 has to be regarded for the complete electrical device. Therefore, the maximum creepage and clearance distances of the mated connectors are specified for consideration as a part of the whole current path. In practice, reductions in creepage or clearance distances may occur due to the conductive pattern of the printed board or the wiring used, and have to be taken into account separately. As a result the creepage and clearance distances for the application may be reduced compared to those of the connector.	
Dielectric strength	IEC 60512 test 4a	contact - contact 500 V <sub>rms</sub>	
Contact resistance	IEC 60512 test 2a	< 25 mΩ < 35 mΩ (Board-to-Board Height 18.50 - 20.00 mm) < 10 mΩ (cable assemblies)	< 10 mΩ
Insulation resistance	IEC 60512 test 3a	> 10 <sup>4</sup> MΩ	
Vibration, sine	IEC 60512 test 6d	10 - 2000 Hz 20 g	
Contact disturbance (while vibration test)	IEC 60512 test 2e	< 1 μs	
Shock halvesine	IEC 60512 test 6c	50 g 11 ms	
Contact disturbance (while shock test)	IEC 60512 test 2e	< 1 μs	
Mechanical operation	IEC 60512 test 9a	500 mating cycles	
Insertion and withdrawal force max.	IEC 60512 test 13b	0.5 N per contact	
Gauge retention force	IEC 60512 test 16e	> 0.1 N	
<b>Processing Conditions</b>			
Hand soldering temperature max.	IEC 60068-2-20	3.5 s at 350 °C	
Dip soldering temperature max.	IEC 60068-2-20	10 s at 260 °C	
Reflow soldering temperature max.	JEDEC J-STD-020	20 - 40 s at 260 °C	
Coplanarity		< 0.1 mm	

# ELECTRICAL AND MECHANICAL CHARACTERISTICS

## Technical Data

Description	Standard	PCB Connectors, Cable Assemblies, B-to-B Adapter	Board-on IDC (Ribbon Cable AWG 30, 250 mm)
<b>Housing Material</b>			
Insulation body			LCP
CTI value	IEC 112		175
UL flame rating			UL 94 V-0
UL file plastic material			E83005
<b>Contact Material</b>			
Base material			Cu alloy
Mating area		gold plating	-
Termination area			Sn
<b>Environment Compatibility</b>			
Recycling		no flame-retardant additives, no toxic additives allow easy recycling	
<b>Product Approval</b>			
UL/CSA			E84703

Partial LV214 testing for selected SMC configurations done. If you want to know more, please contact TE/ERNI.  
In general, testings are done according to connector standards. No liability for usage of connectors in the application.

# ELECTRICAL AND MECHANICAL CABLE CHARACTERISTICS

## Technical Data Flat Ribbon Cables

Description	Standard cable (PVC)	High Temperature Cable (TPE-S)	Halogen-free Cable (Polyolefin TPE-O)
Cross section	AWG-30/ 7/ 0.06 mm <sup>2</sup>		
Conductor	stranded Cu wire, tinned, 7x0.102 / 0.06 mm <sup>2</sup>		
Coded wire	available		
Insulation	PVC gray (similar to RAL 78032)	TPE-S gray (similar to RAL 78032)	TPE-O gray (similar to RAL 78032)
Insulation thickness	min. 0.1mm		
Shore hardness	94 ±2 (Shore A)	52 ±3 (Shore D)	94 ±2 (Shore A) resp. 50 ±3 (Shore D)
<b>Technical Data</b>			
Temperature range	-20/105 °C (fixed) -10/105 °C (mobile)	-60/125 °C (fixed) -40/125 °C (mobile)	-40/105 °C (fixed) -20/105 °C (mobile)
Dielectric strength	1500 V <sub>rms</sub>	1000 V <sub>rms</sub>	1200 V <sub>rms</sub>
Conductor resistance	≤ 350 Ω/km at 20 °C		
Insulation resistance	≥ 20 MΩ x km at 20 °C		
Impedance	125 Ω (wire-wire) 80 Ω (Ground-Signal-Ground)	136 Ω (wire-wire)	110 Ω (wire-wire) 75 Ω (Ground-Signal-Ground)
Bending cycles (typical)	min. 1 million at 20 x cable diameter		
RoHS	compliant		
Flame rating	UL 94 VW-1	IEC 60332-1-2	UL 1581 (Horizontal Flame Test)

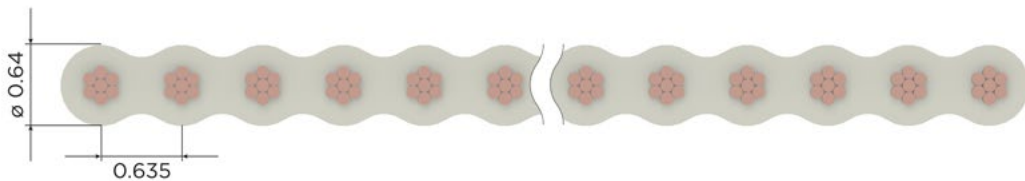

# HIGH FREQUENCY CHARACTERISTICS

## High-Speed Data Transmission

SMC connectors as solution for unshielded high-speed applications. The practically continuous impedance profile allows for more secure data transmission rates of up to 3 Gbit/s (differential) if the system is suitably designed.

- de-embedded measurement results for the micro backplane/daughter card application
- 50-pin SMC, angled female connector, straight male connector (low profile)
- differential signal transmission

## Insertion Loss

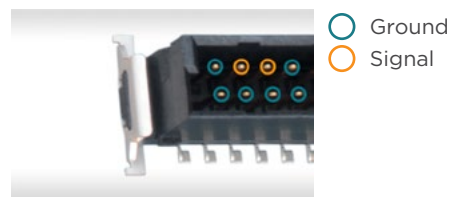
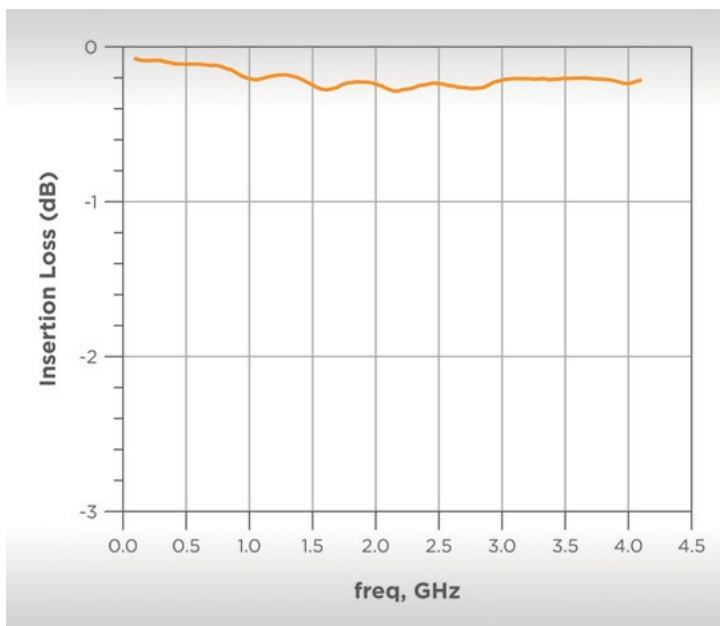

## Near End Crosstalk (Next)

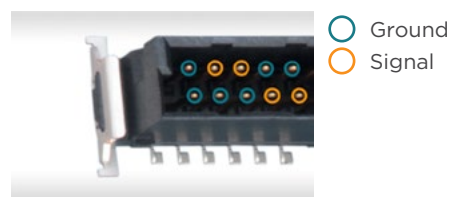
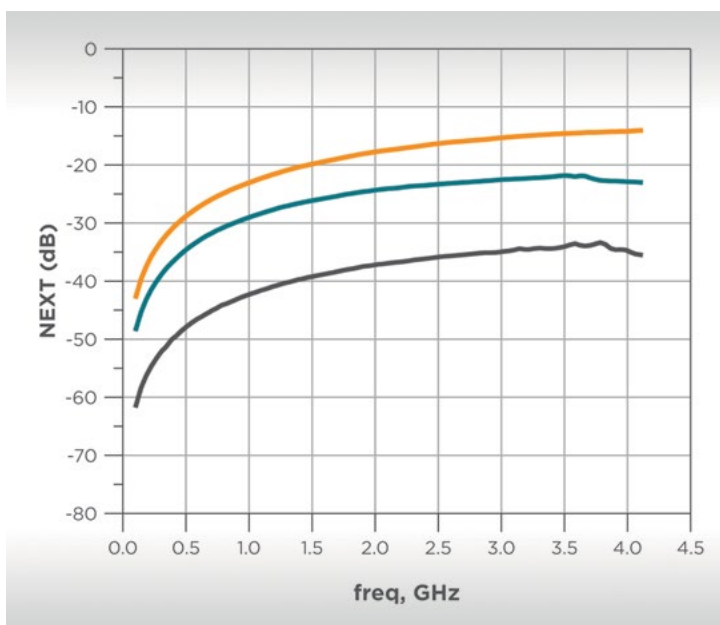

Agressor / Victim	
<span style="color: orange;">—</span>	A2_3 / B2_3
<span style="color: teal;">—</span>	A2_3 / A4_5
<span style="color: black;">—</span>	A2_3 / B4_5 (shown above)

# RIGHT ANGLE MALE

## Product Specification

- Surface mount technology (SMT) termination
- dual row connector
- data rates up to 3 Gbit/s
- location pegs for exact board placement
- black insulation body for fast and reliable visual recognition
- automated board assembly
- for available part numbers please refer to our website



## Dimensional Drawings

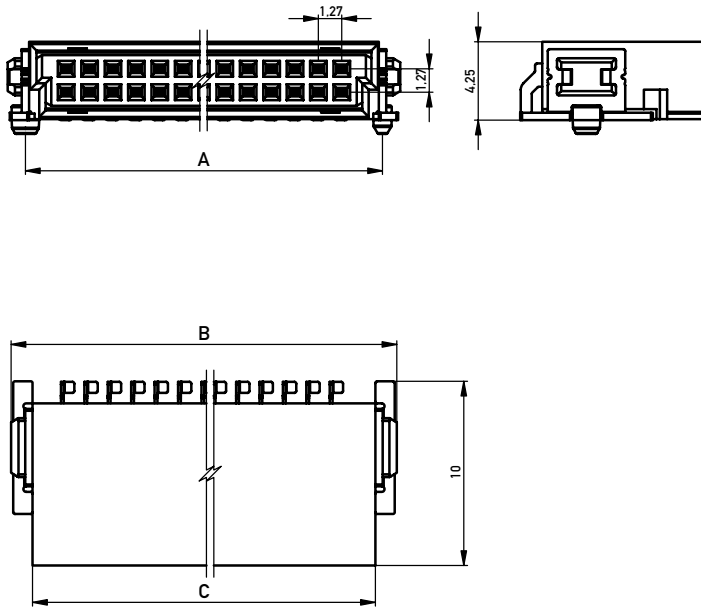

No. of Contacts	A	B	C
12	10.77	12.70	10.35
16	13.31	15.24	12.91
20	15.85	17.78	15.45
26	19.66	21.59	19.26
32	23.47	25.40	23.07
40	28.55	30.48	28.15
50	34.90	36.83	34.50
68	46.33	48.26	45.93
80	53.95	55.88	53.55

All dimensions in mm.

## Recommended Layout

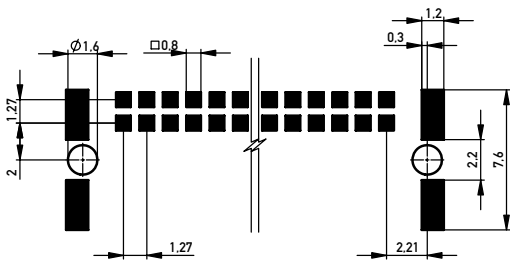

# RIGHT ANGLE FEMALE

## Product Specification

- SMT termination
- dual row connector
- data rates up to 3 Gbit/s
- location pegs for exact board placement
- black insulation body for fast and reliable visual recognition
- automated board assembly
- for available part numbers please refer to our website



## Dimensional Drawings

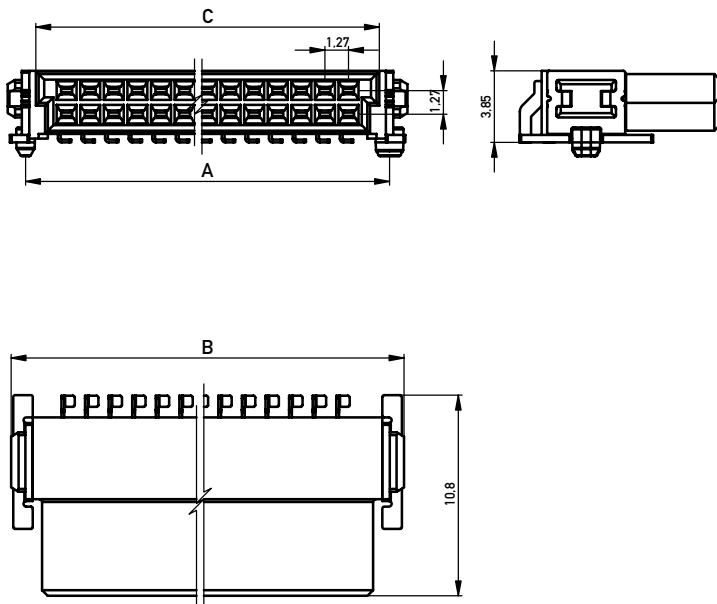

No. of Contacts	A	B	C
12	10.77	12.70	9.37
16	13.31	15.24	11.91
20	15.85	17.78	14.45
26	19.66	21.59	18.26
32	23.47	25.40	22.07
40	28.55	30.48	27.15
50	34.90	36.83	33.50
68	46.33	48.26	44.93
80	53.95	55.88	52.55

All dimensions in mm.

## Recommended Layout

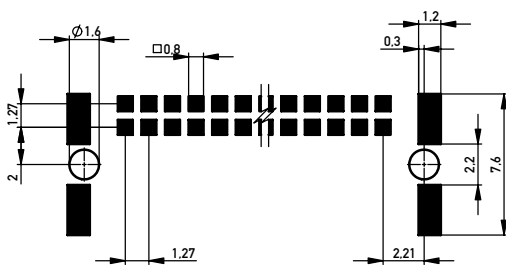



# VERTICAL MALE

## Product Specification

- SMT termination
- dual row connector
- data rates up to 3 Gbit/s
- location pegs for exact board placement
- black insulation body for fast and reliable visual recognition
- automated board assembly
- 3 stacking heights (1.75, 3.25, 4.85 mm)
- for available part numbers please refer to our website

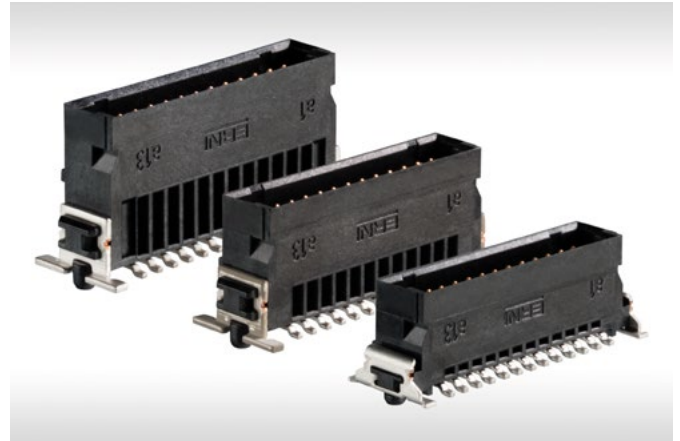

## Dimensional Drawings

Unmated Stacking Height 3.25 mm

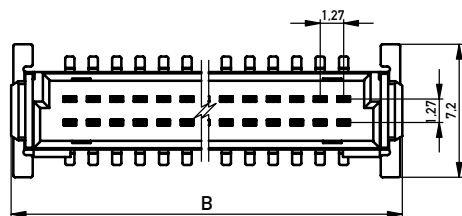
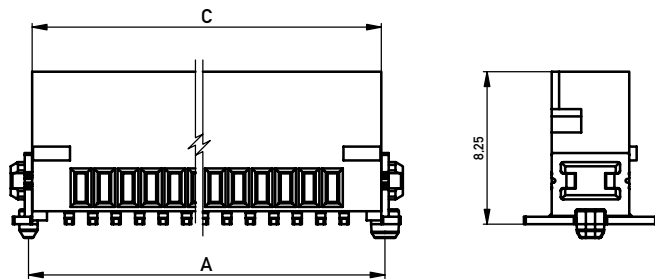

No. of Contacts	A	B	C
12	10.77	12.70	10.37
16	13.31	15.24	12.91
20	15.85	17.78	15.45
26	19.66	21.59	19.26
32	23.47	25.40	23.07
40	28.55	30.48	28.15
50	34.90	36.83	34.50
68	46.33	48.26	45.93
80	53.95	55.88	53.55

All dimensions in mm.

## Recommended Layout

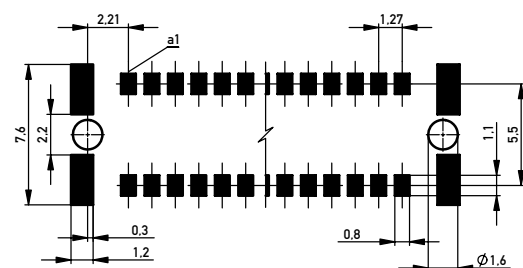

# VERTICAL MALE PRESSFIT

## Product Specification

- pressfit termination
- dual row connector
- data rates up to 3 Gbit/s
- black insulation body for fast and reliable visual recognition
- virtually automated board assembly
- stacking height 3.25 mm
- press-in tools and toggle presses available from ERNI
- for available part numbers please refer to our website

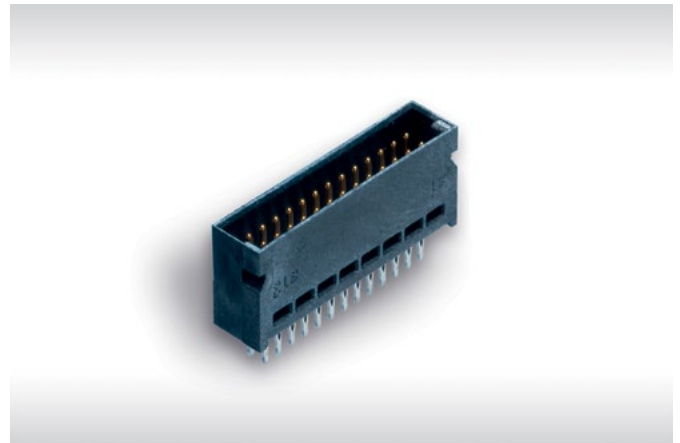

## Dimensional Drawings

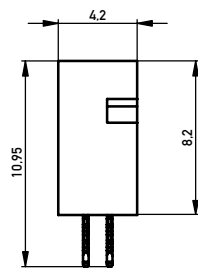
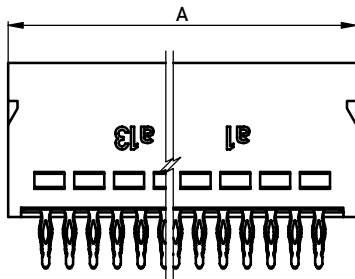

No. of Contacts	A
12	10.35
26	19.24
50	34.48
68	45.91
80	53.53

All dimensions in mm.

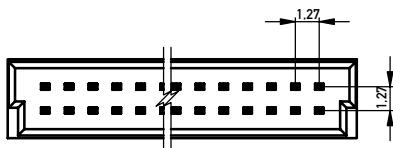

## Recommended Layout | Hole Design

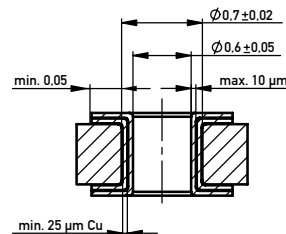
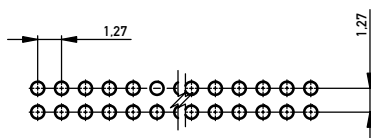

# VERTICAL FEMALE

## Product Specification

- SMT termination
- dual row connector
- data rates up to 3 Gbit/s
- location pegs for exact board placement
- black insulation body for fast and reliable visual recognition
- automated board assembly
- 3 stacking heights (6.25, 9.05, 13.65 mm)
- for available part numbers please refer to our website

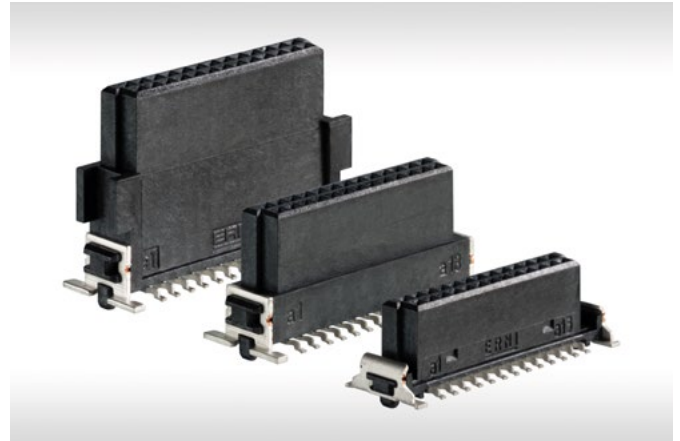

## Dimensional Drawings

Unmated Stacking Height 9.05 mm

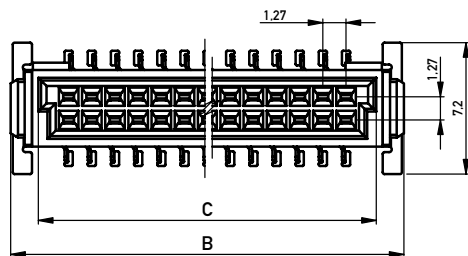
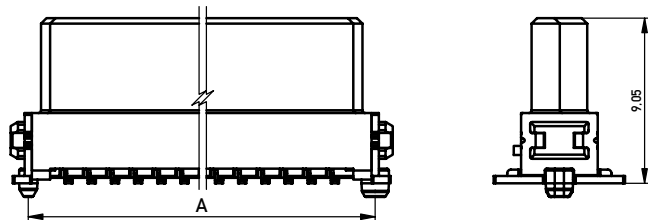

No. of Contacts	A	B	C
12	10.77	12.70	9.37
16	13.31	15.24	11.91
20	15.85	17.78	14.45
26	19.66	21.60	18.26
32	23.47	25.40	22.07
40	28.55	30.48	27.15
50	34.90	36.80	33.50
68	46.33	48.20	44.93
80	53.95	55.80	52.55

All dimensions in mm.

## Recommended Layout

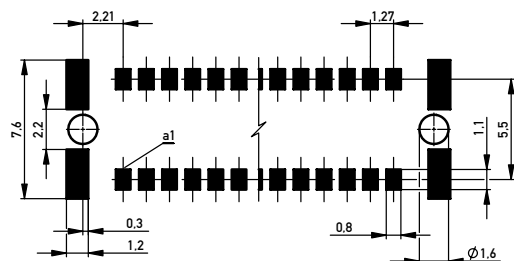

# RIGHT ANGLE MALE WITH LOCKING SYSTEM

## Product Specification

- two types of interlocking:
  - positive lock (blue colored): unlockable i.e. by tool, tip of pen
  - friction lock (black colored): unlockable without any tool
- SMT termination
- data rates up to 3 Gbit/s
- location pegs for exact board placement
- automated board assembly
- for available part numbers please refer to our website



## Dimensional Drawings

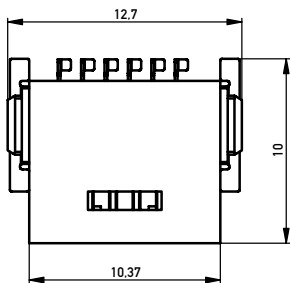
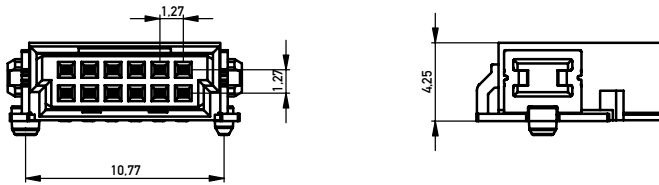

## Recommended Layout

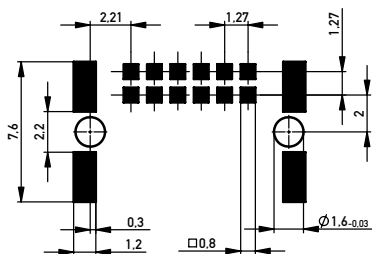

# RIGHT ANGLE FEMALE WITH LOCKING SYSTEM

## Product Specification

- two types of interlocking:
  - positive lock (blue colored): unlockable i.e. by tool, tip of pen
  - friction lock (black colored): unlockable without any tool
- SMT termination
- data rates up to 3 Gbit/s
- location pegs for exact board placement
- automated board assembly
- for available part numbers please refer to our website

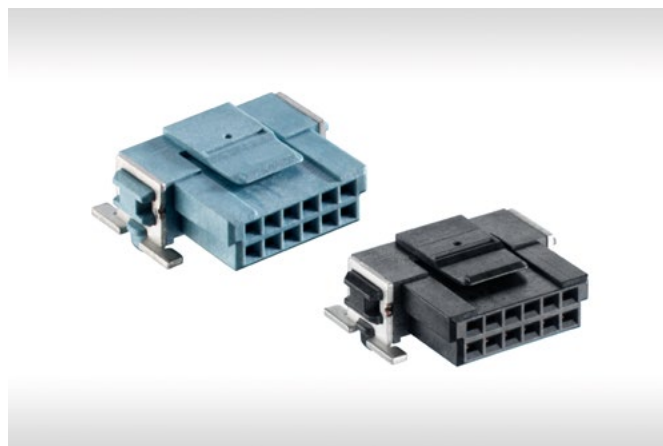

## Dimensional Drawings

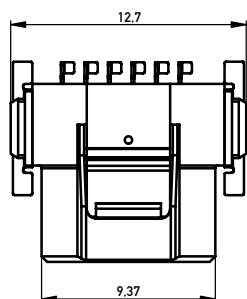
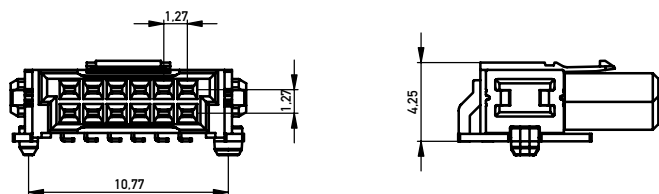

## Recommended Layout

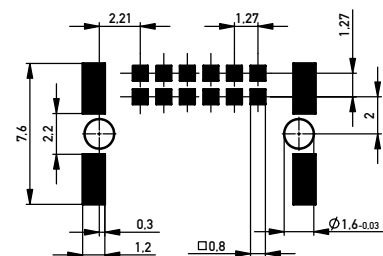

# BOARD-TO-BOARD ADAPTER

## Product Specification

- Board-to-Board adapter for parallel PCB distances of 20-40 mm
- moulded (hotmelt) versions for improved environmental resistance and finger safe protection
- single-sided locking of Board-to-Board adapters on low-profile female connectors
- enables the mating and release of two boards always on one specified side
- for available part numbers please refer to our website



## Dimensional Drawings

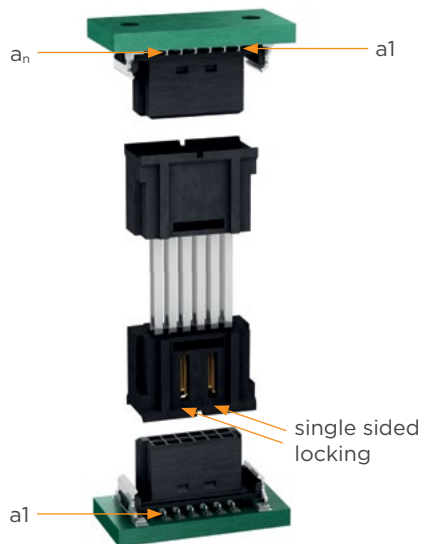
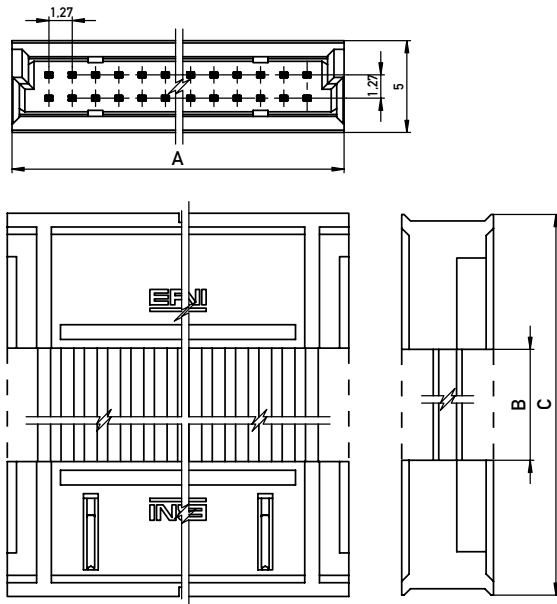

No. of Contacts	A
12	10.37
26	19.26
50	34.50
68	45.93
80	53.55

All dimensions in mm.

B-to-B Adapter (Board-Distance)	B	C
20	3.5	18.2
22	5.5	20.2
24	7.5	22.2
26	9.5	24.2
28	11.5	26.2
30	13.5	28.2
32	15.5	30.2
34	17.5	32.2
36	19.5	34.2
38	21.5	36.2

# BOARD-ON IDC

## Product Specification

- permanent wire-to-board connection
- SMT and IDC termination
- dual row connector
- data rates up to 3 Gbit/s
- location pegs for exact board placement
- black insulation body for fast and reliable visual recognition
- flat ribbon cables AWG 30
- easy assembly with standard toggle press
- for available part numbers please refer to our website



## Dimensional Drawings | Recommended Layout

Board-on Connectors

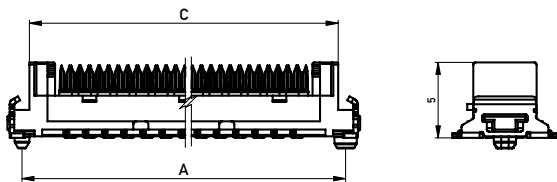

No. of Contacts	A	B	C
12	12.77	14.70	11.78
26	21.66	23.59	20.67
50	36.90	38.83	35.91

All dimensions in mm.

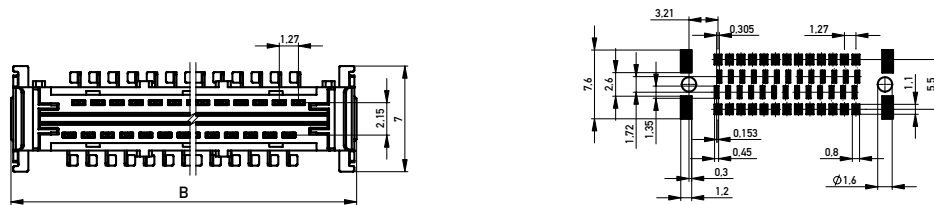

Board-on Cable Guide

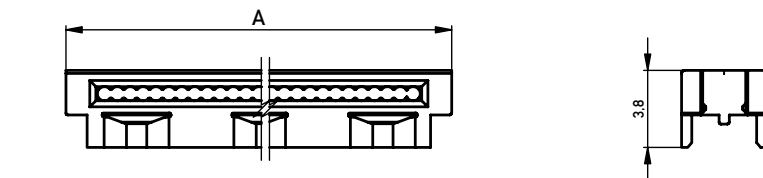





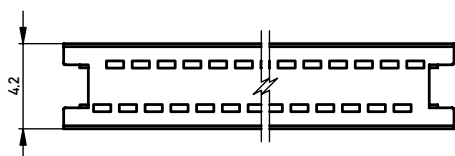

No. of Contacts	A	B
12	10.78	6.98
26	19.67	15.87
50	34.91	31.11

All dimensions in mm.

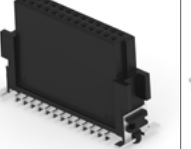
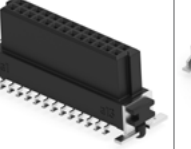
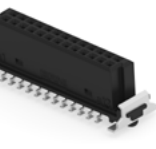

## SMC Product Selection

	Vertical Male (Type Q)			Vertical Female (Type Q)		
						
Positions	1.75mm Height	3.25mm Height	4.85mm Height	13.65mm Height	9.05mm Height	6.25mm Height
12 pin	<b>244836-E</b>	<b>244854-E</b>	<b>234206-E</b>	<b>234198-E</b>	154717-E	154805-E
16 pin	<b>254587-E</b>	254536-E	254414-E	354070-E	354062-E	<b>354055-E</b>
20 pin	254588-E	254537-E	<b>254415-E</b>	<b>354071-E</b>	354063-E	354056-E
26 pin	<b>244837-E</b>	244855-E	234207-E	204763-E	154718-E	<b>154806-E</b>
32 pin	254589-E	254538-E	<b>254416-E</b>	<b>354072-E</b>	354064-E	354057-E
40 pin	<b>254590-E</b>	254539-E	254417-E	354073-E	<b>354065-E</b>	204632-E
50 pin	<b>244838-E</b>	244856-E	234208-E	<b>234199-E</b>	154719-E	154807-E
68 pin	244839-E	<b>244857-E</b>	234209-E	234200-E	154720-E	<b>154808-E</b>
80 pin	<b>244840-E</b>	244858-E	234210-E	234201-E	154721-E	154809-E

	Right Angle Male (Type B)	Right Angle Female (Type B)	IDC Female (Type B)
			
Positions			
12 pin	<b>154763-E</b>	154740-E	214345-E
16 pin	354094-E	354078-E	294813-E
20 pin	<b>354095-E</b>	354079-E	294814-E
26 pin	<b>154764-E</b>	154741-E	214346-E
32 pin	<b>354096-E</b>	354080-E	294815-E
40 pin	<b>354097-E</b>	354081-E	294816-E
50 pin	<b>154765-E</b>	<b>154742-E</b>	214347-E
68 pin	<b>154766-E</b>	154743-E	214348-E
80 pin	<b>154767-E</b>	<b>154744-E</b>	214349-E



# CABLE ASSEMBLIES

## Product Specification

- cable assemblies with IDC female connectors
- ribbon cable AWG 30/7
- three different cable types
- for available part numbers please refer to our website

## Dimensional Drawings

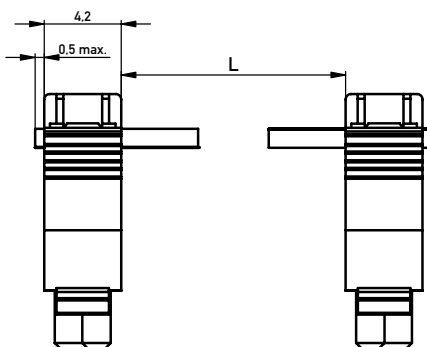
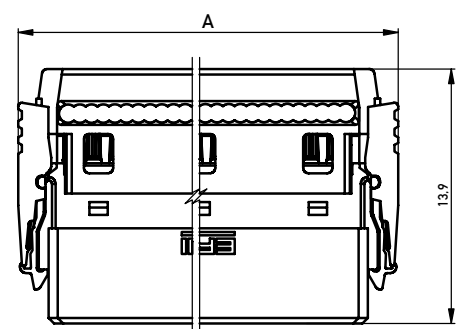
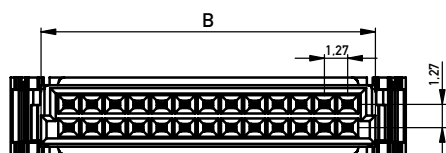

No. of Contacts	A	B
12	12.69	9.37
16	15.23	11.91
20	17.77	14.45
26	21.58	18.26
32	25.39	22.07
40	32.53	27.15
50	38.88	33.50
68	50.31	44.93
80	57.93	52.55

All dimensions in mm.

# CABLE ASSEMBLIES

## Configurations

### Standard

Connector #1

Connector #2

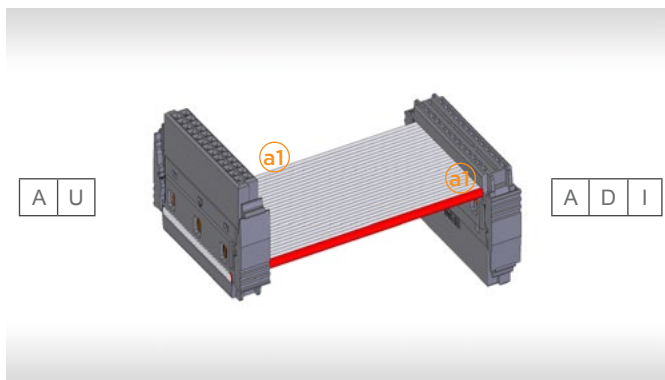
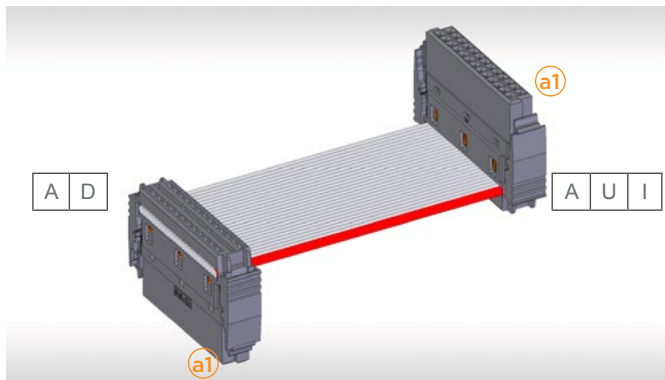
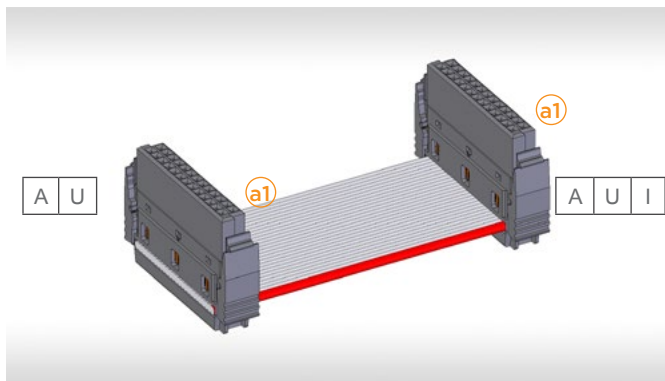

### Crossed

Connector #2

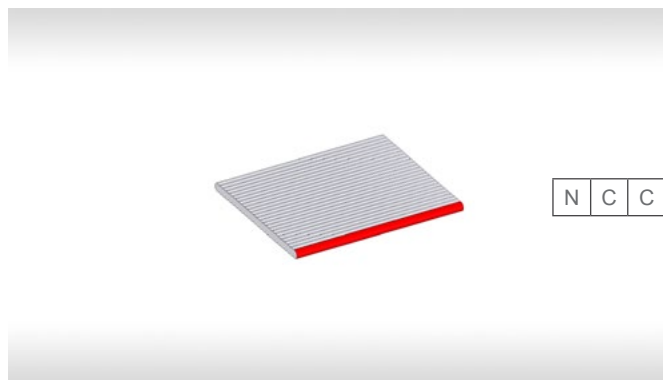
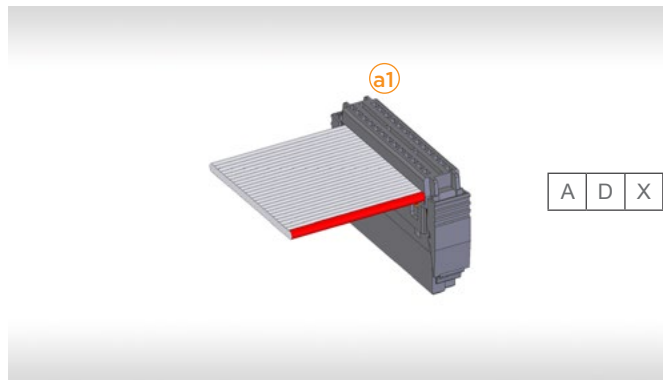
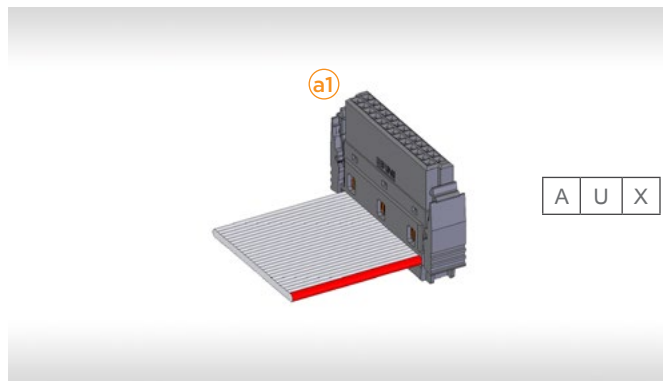

# CABLE ASSEMBLIES

## Cable Types



### Standard

- standard ribbon cable with PVC insulation
- AWG 30/7
- excellent abrasion and cut resistance
- temperature range: -10 °C to +105 °C
- UL2678

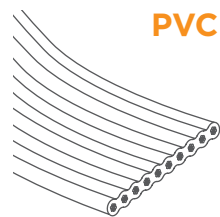

### High Temperature

- high temperature resistant ribbon cable with TPE-S insulation
- AWG 30/7
- excellent abrasion and cut resistance
- temperature range: -40 °C to +125 °C

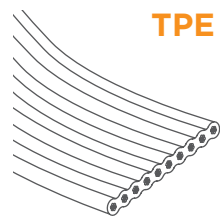

### Halogen-free

- halogen-free ribbon cable with TPE-O insulation
- AWG 30/7
- excellent abrasion and cut resistance
- oil-resistant (ASTM 2)
- temperature range: -20 °C to +105 °C
- UL22092

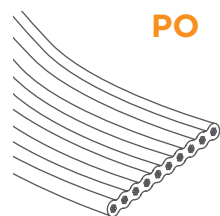

# CABLE ASSEMBLIES

## Ordering Information Standard Cable Assemblies

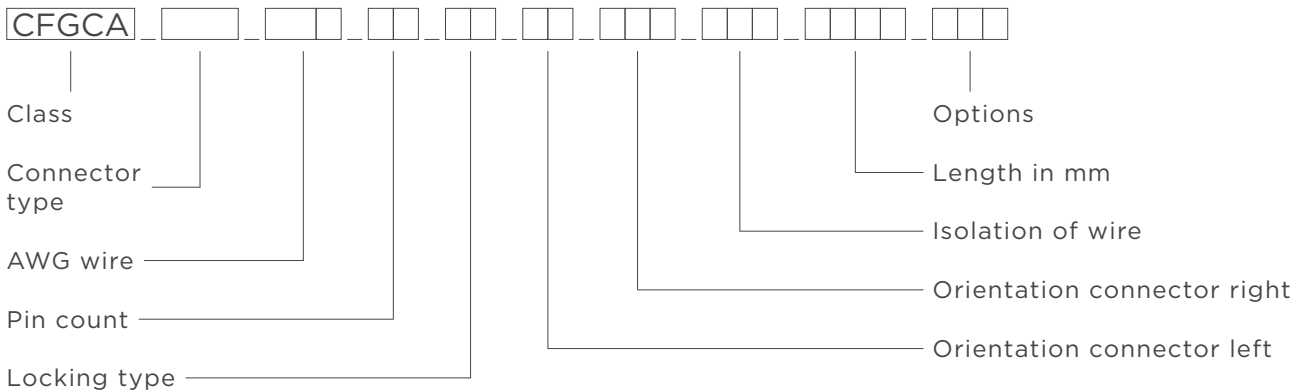

### Example for a standard configuration:

**CFGCA** **SMC** **30R** **12** **LL** **AU** **AUI** **PVC** **0175** **ANN**

Ordering code field	Number of digits	Example configuration	Composition of the configuration
Class	5	CFGCA	<b>C</b> on <b>F</b> i <b>G</b> urable <b>C</b> able <b>A</b> ssembly
Connector type	3	SMC	<b>SMC</b>
AWG wire	3	30R	1st and 2nd column: <b>30</b> 3rd column: <b>R</b> ibbon Cable
Pin count	2	12	<b>12, 16, 20, 26, 32, 40, 50, 68, 80</b>
Locking type	2	LL	<b>L</b> ocking <b>L</b> atches <b>S</b> ecure <b>L</b> ock
Orientation connector left	2	AU	<b>A</b> ngeled <b>U</b> p <b>A</b> ngeled <b>D</b> own
Orientation connector right	3	AUI	1st and 2nd column: <b>A</b> ngeled <b>U</b> p <b>A</b> ngeled <b>D</b> own <b>N</b> ot <b>C</b> onne <b>C</b> ted 3rd column: <b>I</b> -connected (1:1) <b>X</b> -connected (1:N)
Isolation of wire	2 - 4	PVC	<b>PVC</b> : -10 °C to +105 °C <b>TPE</b> : -40 °C to +125 °C <b>PO</b> : -20 °C to +105 °C, halogen free
Length in mm	4	0175	<b>175</b> mm / 25 - 2500 mm possible
Options	3	ANN	1st column: <b>A</b> symmetric <b>S</b> ymmetric 2nd and 3rd column: custom <b>P</b> rint <b>U</b> L Label <b>P</b> rint ad <b>U</b> L Label <b>N</b> o print <b>N</b> o UL label

---

# CABLE ASSEMBLIES

## Product Specific Technical Notes

- intended use: the offered products, i.e. cable assemblies, are components used in devices for internal wiring in non-critical industrial applications
- not intended to be used in live-support applications, no safety-classified applications, not intended for automotive use, not intended for applications with danger to life and limb
- desired audience: (professional) company customers who assume the full responsibility for their products including the ERNI cable assembly product under consideration
- customer has to carefully check the product's appropriateness for the desired use (application) with the help of its technical specifications and additionally verify that the operation of the product in said application is in agreement with all requirements that may be applicable under the scope of the actual application (applicable regulation, law, and whatever more)
- product solely ERNI-internally sampled and released - customer FAI report will not be provided (also includes PPAps, CofCs, acceptance test certificates and IMDS Data)
- ERNI may change suppliers or mix materials from various sources as long as the specification layed out here will be maintained (assumption of fit-form-function)
- outside these product offerings customer-specific assemblies to be inquired separately

---

## Connect With Us

We make it easy to connect with our experts and are ready to provide the support you need. Visit [www.te.com/support](https://www.te.com/support) to chat with a Product Information Specialist.

---

### te.com

2024 TE Connectivity. All Rights Reserved.

TE Connectivity, TE connectivity (logo), ERNI and Every Connection Counts are trademarks owned or licensed by the TE Connectivity family of companies. All other logos, products and/or company names referred to herein might be trademarks of their respective owners.

The information given herein, including drawings, illustrations and schematics which are intended for illustration purposes only, is believed to be reliable. However, TE Connectivity makes no warranties as to its accuracy or completeness and disclaims any liability in connection with its use. TE Connectivity's obligations shall only be as set forth in TE Connectivity's Standard Terms and Conditions of Sale for this product and in no case will TE Connectivity be liable for any incidental, indirect or consequential damages arising out of the sale, resale, use or misuse of the product. Users of TE Connectivity products should make their own evaluation to determine the suitability of each such product for the specific application.

AK 9/24 Original

### CATALOG

TE Connectivity

ERNI Deutschland GmbH  
a TE Connectivity Ltd. company  
Seestraße 9  
73099 Adelberg  
Germany

Tel +49 7166 50-0  
[www.te.com](https://www.te.com)