

TE Connectivity DEUTSCH 983 Series/EN2997 Series Connectors

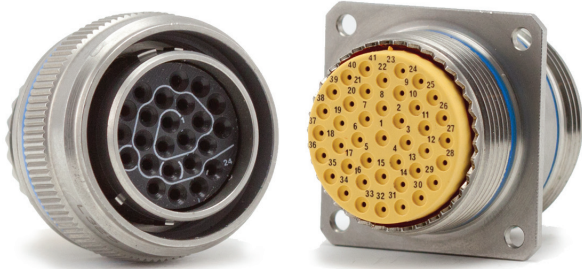

HIGH-PERFORMANCE AEROSPACE CONNECTORS FOR AIRCRAFT ENGINES & BOOSTERS

TE DEUTSCH 983 series / EN2997 series connectors are enhanced over standard MIL-DTL-83723 mil spec connectors. TE DEUTSCH 983 / EN2997 connectors have improvements such as anti-rotation, reduced elastomer barriers for use with newer and older generation wires and shell-to-shell metal bottoming. These TE DEUTSCH aerospace connectors are designed for military and commercial aircraft engines and boosters. For full product details on TE DEUTSCH 983 series / EN2997 series connectors, please see the specifications below.

APPLICATIONS

- High-performance military aircraft
- Commercial aircraft
- Communications equipment
- Armored personnel carriers & tanks
- High temperature industrial equipment

FEATURES

- High-reliability
- EMI-shielding protection
- Operates at extreme temperatures
- High vibration applications
- Meets and exceeds MIL-DTL-83723 specification
- EN2997 qualified

MATERIALS AND FINISHES

Shell	Aluminium Alloy or Stainless Steel
Shell Plating	Nickel, Olive Drab Cadmium, Black Anodized
Contacts	Copper Alloy
Contact Platings	Gold plating
Insulator	Thermo-setting, Hermetic - Sintered Glass
Seals	Silicone

ELECTRICAL DATA

Wire Range Sizes	12-24AWG
Insulation Resistance	5000 Megaohms minimum at +260C (500F) and 65% Relative Humidity

Test Voltage

SEA LEVEL	SEA LEVEL VAC RMS
Sea Level	1500Vrms @ 50Hz mated connectors
15,000M (49,212 feet)	1000Vrms @ 50Hz mated connectors
30,000M (98,425 feet)	200Vrms @ 50Hz mated connectors

Current Rating

WIRE SIZE	CONTACT SIZE	MAX. CURRENT RATING PER CONTACT AMPS	HERMETIC
24	20	3	5
22	20	5	-
20	20	7.5	-
18	20	7.5	-
20	16	7.5	-
18	16	11	-
16	16	13	10
14	12	17	-
12	12	23	17

MECHANICAL DATA

Operating Temperature	W & WS - +175°C (+347°F) A, R, RS, K, S, Y - +200°C (+392°F) KE, SE, YE - +260°C cyclic (+500°F)
-----------------------	--

Wire Sealing Range

CONTACT SIZE	MINIMUM		MAXIMUM	
	IN	MM	IN	MM
20	0.033	0.85	0.083	2.10
16	0.047	1.20	0.106	2.70
12	0.075	1.90	0.157	4.00
8 (8 AWG)	0.161	4.10	0.173	4.40

Insulation Strip Length

CONTACT SIZE	STRIP LENGTH	
	IN	MM
20	0.188	4.77
16	0.283	7.18
12	0.283	7.18
8	0.354	8.99

Mating Life A, W, WS, R, RS - 250 cycles; K, S, Y, KE, SE, YE - 500 cycles

Salt Spray A, R, RS - 48 hours per EN 2591-307
W, WS, K, S, Y, KE, SE, YE - 500 hours per EN2591-307

Vibration 10 - 2000 Hz along 2 axis per EN2591 test 403, method B

Shock 300 g/ 3ms per EN2591-402

Shielding efficiency as per EN 2591-213

Fire resistance K, S, KE, SE per EN2591-318

Sealed $16 \cdot 10^{-6} \text{ m}^3/\text{h} / 100 \text{ kPa}$

Contact Type Crimp, Power, Quadrax

Number of Circuits 3 to 61

Contact Insertion Rear Insertion/Rear Extraction with simple plastic tool

Polarization Five keyways with optional keyway orientation

Approvals EN2997

HOW TO ORDER 983/EN2997 SERIES CONNECTORS - COMMERCIAL

1

2

3

4

5

6

983-0

A

22-55

P

N

L

SHELL STYLE

FINISH

LAYOUT

CONTACT

POLARIZATION

MODIFIER

(Commercial part number example)

STEP 1: SELECT SHELL STYLE, PLUG OR RECEPTACLE

RECEPTACLES

Mates with

PLUGS



983-0

Square Flange Receptacle

983-1

Solder Receptacle - Hermetic Only

983-7

Jam Nut Receptacle

983-6

Plug

STEP 2: SELECT FINISH

A = Black anodized
W = Olive Drab
WS = Olive Drab RFI Shielding
R = Nickel

RS = Nickel RFI Shielding
K = Stainless Steel
S = Stainless Steel RFI Shielding
Y = Stainless Hermetic

KE = Stainless High Temp
SE = Stainless Shielded High Temp
YE = Stainless High Temp Hermetic

STEP 3: SELECT LAYOUT

⇒ See pages 18-19 for listing by # of contacts

INSERT	TOTAL	20	16	12	QUADRAX
08-03	3	3			
08-98	3	3			
10-05	5	5			
10-06	6	6			
12-03	3		3		
12-12	12	12			
14-04	4			4	
14-07	7		7		
14-12	12	9	3		
14-15	15				
16-10	10		10		
16-24	24	24			
18-02	2				2
18-08	8			8	
18-14	14		14		
18-31	31	31			
20-04	4				4
20-16	16		16		
20-25	25	19		6	
20-28	28	24		4	
20-39	39	37	2		
20-41	41	41			
22-12	12			12	
22-19	19		19		
22-30	30	24		6	
22-32	32	26		6	
22-39	39	27	12		
22-55	55	55			
24-30	30		30		
24-57	57	55		2	
24-61	61	61			
28-06	6				6
28-42	42		42		

STEP 4: SELECT CONTACT



P = Pin

S = Socket

STEP 5: SELECT POLARIZATION



N = Normal
6 = Next Most Popular

7 = Not Popular
8 = Check for Availability

9 = Check for Availability
Y = Check for Availability
(not available in size 8)

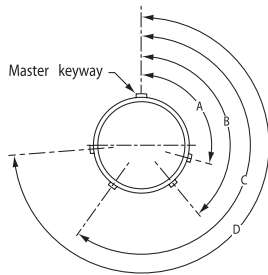

Mating Face of Plug

KEY POSITION	SHELL SIZE 8				SHELL SIZE 10				SHELL SIZE 12 - 28			
	A	B	C	D	A	B	C	D	A	B	C	D
N	105	140	215	265	105	140	215	265	105	140	215	265
6	102	132	248	320	102	132	248	320	18	148	192	259
7	80	118	230	312	80	118	230	312	92	152	222	342
8	35	140	205	275	35	140	205	275	84	152	204	334
9	64	155	234	304	64	155	234	304	24	135	199	240
Y	-	-	-	-	25	115	220	270	98	152	268	338

STEP 6: SELECT MODIFIER



Blank = Supplied with contacts
L = Supplied without contacts

HOW TO ORDER 983/EN2997 SERIES CONNECTORS - ASD-STAN

1	2	3	4	5
EN2997A	0	22-55	M	N
FINISH	SHELL STYLE	LAYOUT	CONTACT	POLARIZATION

(ASD-STAN part number example)

STEP 1: SELECT FINISH

- | | | |
|--|--|--|
| EN2997A = Black anodized | EN2997RS = Nickel RFI Shielding | EN2997KE = Stainless High Temp |
| EN2997W = Olive Drab | EN2997K = Stainless Steel | EN2997SE = Stainless Shielded High Temp |
| EN2997WS = Olive Drab RFI Shielding | EN2997S = Stainless Steel RFI Shielding | EN2997YE = Stainless High Temp Hermetic |
| EN2997R = Nickel | EN2997Y = Stainless Hermetic | |

STEP 2: SELECT SHELL STYLE, PLUG OR RECEPTACLE

RECEPTACLES ← Mates with → PLUGS



EN2997_0
Square Flange Receptacle



EN2997_1
Solder Receptacle - Hermetic Only



EN2997_7
Jam Nut Receptacle



EN2997_6
Plug

STEP 3: SELECT LAYOUT

↔ See pages 18-19 for listing by # of contacts

INSERT	TOTAL	20	16	12	QUADRAX
08-03	3	3			
08-98	3	3			
10-05	5	5			
10-06	6	6			
12-03	3		3		
12-12	12	12			
14-04	4			4	
14-07	7		7		
14-12	12	9	3		
14-15	15				
16-10	10		10		
16-24	24	24			
18-02	2				2
18-08	8			8	
18-14	14		14		
18-31	31	31			
20-04	4				4
20-16	16		16		
20-25	25	19		6	
20-28	28	24		4	
20-39	39	37	2		
20-41	41	41			
22-12	12			12	
22-19	19		19		
22-30	30	24		6	
22-32	32	26		6	
22-39	39	27	12		
22-55	55	55			
24-30	30		30		
24-57	57	55		2	
24-61	61	61			
28-06	6				6
28-42	42		42		

STEP 4: SELECT CONTACT



- M** = Pin
- F** = Socket
- A** = Less Pins
- B** = Less Sockets
- C** = Pin contact size 20, with crimp barrel for 18 AWG
- D** = Socket contact size 20, with crimp barrel for 18 AWG

NOTE: A, M, or C marked with M per EN2997
 B, F, or D marked with F per EN2997

STEP 5: SELECT POLARIZATION



- N** = Normal
- 6** = Next Most Popular

- 7** = Not Popular
- 8** = Check for Availability

- 9** = Check for Availability
- Y** = Check for Availability (not available in size 8)

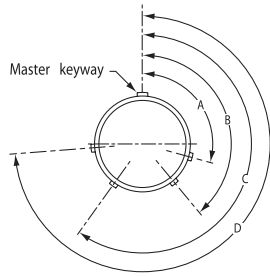

Mating Face of Plug

KEY POSITION	SHELL SIZE 8				SHELL SIZE 10				SHELL SIZE 12 - 28			
	A	B	C	D	A	B	C	D	A	B	C	D
N	105	140	215	265	105	140	215	265	105	140	215	265
6	102	132	248	320	102	132	248	320	18	148	192	259
7	80	118	230	312	80	118	230	312	92	152	222	342
8	35	140	205	275	35	140	205	275	84	152	204	334
9	64	155	234	304	64	155	234	304	24	135	199	240
Y	-	-	-	-	25	115	220	270	98	152	268	338

HOW TO ORDER BACC63CM/CN SERIES CONNECTORS

	1	2	3	4	5
BACC63	CM	2255	P	N	A
PREFIX	SHELL STYLE	LAYOUT	CONTACT	POLARIZATION	MODIFIER

(BACC part number example)

STEP 1: SELECT SHELL STYLE, PLUG OR RECEPTACLE

RECEPTACLES



CN
Square Flange Receptacle

← Mates with →

PLUGS



CM
Plug
Accessory teeth per MIL-DTL-83723 (Normal 3 teeth)

STEP 2: SELECT LAYOUT

↔ See pages 18-19 for listing by # of contacts

INSERT	TOTAL	20	16	12	QUADRAX
0803	3	3			
0898	3	3			
1005	5	5			
1006	6	6			
1203	3		3		
1212	12	12			
1404	4			4	
1407	7		7		
1412	12	9	3		
1415	15				
1610	10		10		
1624	24	24			
1802	2				2
1808	8			8	
1814	14		14		
1831	31	31			
2004	4				4
2016	16		16		
2025	25	19		6	
2028	28	24		4	
2039	39	37	2		
2041	41	41			
2212	12			12	
2219	19		19		
2230	30	24		6	
2232	32	26		6	
2239	39	27	12		
2255	55	55			
2430	30		30		
2457	57	55		2	
2461	61	61			
2806	6				6
2842	42		42		

STEP 3: SELECT CONTACT



P = Pin

S = Socket

STEP 4: SELECT POLARIZATION



N = Normal

6 = Next Most Popular

7 = Not Popular

8 = Check for Availability

9 = Check for Availability

Y = Check for Availability
(not available in size 8)

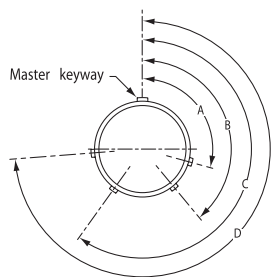

Mating Face of Plug

KEY POSITION	SHELL SIZE 8				SHELL SIZE 10				SHELL SIZE 12 - 28			
	A	B	C	D	A	B	C	D	A	B	C	D
N	105	140	215	265	105	140	215	265	105	140	215	265
6	102	132	248	320	102	132	248	320	18	148	192	259
7	80	118	230	312	80	118	230	312	92	152	222	342
8	35	140	205	275	35	140	205	275	84	152	204	334
9	64	155	234	304	64	155	234	304	24	135	199	240
Y	-	-	-	-	25	115	220	270	98	152	268	338

STEP 5: SELECT MODIFIER



A = Supplied with contacts

Blank = Supplied without contacts

LAYOUTS BY NUMBER OF CONTACTS

o=20 ∅=16 ●=12 ⊙=8 (Quadrax)

	2		3			4	
LAYOUT	18-02	8-03	8-98*	12-03	14-04	20-04	
# OF CONTACTS	2#8 QUADRAX	3#20	3#20	3#16	4#12	4#8 QUADRAX	
	5		6		7	8	
LAYOUT	10-05	10-06	28-06	14-07	18-08		
# OF CONTACTS	5#20	6#20	6#8 QUADRAX	7#16	8#12		
	10		12			14	
LAYOUT	16-10	12-12	14-12	22-12	18-14		
# OF CONTACTS	10#16	12#20	9#20 3#16	12#12	14#16		

LAYOUTS BY NUMBER OF CONTACTS

○=20 ◊=16 ●=12 ⊙=8 (Quadrax)

	15	16	19	24	25	
LAYOUT # OF CONTACTS	14-15 15#20	20-16 16#16	22-19 19#16	16-24 24#20	20-25 19#20 6#12	
	28	30		31	32	
LAYOUT # OF CONTACTS	20-28 24#20 4#12	22-30 24#20 6#12	24-30 30#16	18-31 31#20	22-32 26#20 6#12	
	39	41	42	55	57	61
LAYOUT # OF CONTACTS	20-39 37#20 2#16	20-41 41#20	28-42 42#16	22-55 55#20	24-57 55#20 2#12	24-61 61#20

PINS

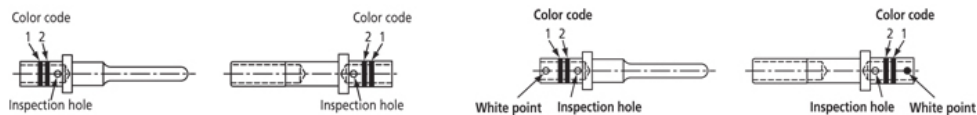

CONTACT SIZE	WIRE CRIMP SIZE RANGE	TYPE	PIN PART NUMBER	COLOR BANDS		WIRE STRIP LENGTHS		WIRE INSULATION SEALING RANGE				WIRE HOLE FILLER
				1	2	IN.	MM	MIN		MAX		
								IN	MM	IN	MM	
20	20,22,24	Standard	006-0937-20A	Red	Red	0.188	4.77	0.033	0.850	0.083	2.10	097-0140-20
20	18,20,22,24	Standard	006-0044-20A	Violet	Red	0.188	4.77	0.033	0.850	0.083	2.10	097-0140-20
20	26,28,30	Standard	006-0972-20	White	Red	0.188	4.77	0.033	0.850	0.083	2.10	097-0140-20
16	16,18,20	Standard	006-0937-16A	Blue	Blue	0.188	4.77	0.047	1.20	0.106	2.70	097-0139-16
16	14,16,18	Standard	006-1102-16	Orange	Blue	0.283	7.18	0.047	1.20	0.106	2.70	097-0139-16
16	20,22,24	Standard	182-0451-16	Red	Blue	0.188	4.77	0.047	1.20	0.106	2.70	097-0139-16
16	26,28,30	Standard	025-0870-16	Black	Blue	0.188	4.77	0.047	1.20	0.106	2.70	097-0139-16
12	12,14	Standard	006-0937-12A	Yellow	Yellow	0.283	7.18	0.075	1.90	0.157	4.00	097-0138-12
20	20,22,24	High-Temperature	097-0015-20	Red	Red	0.188	4.77	0.033	0.850	0.083	2.10	097-0139-20
20	24	High-Temperature	097-0047-20	Blue	Red	0.188	4.77	0.033	0.850	0.083	2.10	097-0139-20
16	16,18,20	High-Temperature	097-0014-16	Blue	Blue	0.283	7.18	0.047	1.20	0.106	2.70	097-0140-16
16	14	High-Temperature	097-0177-16	Blue	Orange	0.283	7.18	0.047	1.20	0.106	2.70	097-0140-16
12	12,14	High-Temperature	097-0165-12	Yellow	Yellow	0.283	7.18	0.075	1.90	0.157	4.00	097-0138-12
20	20,22,24	chromel	006-1186-20	Red	Red	0.188	4.77	0.033	0.850	0.083	2.10	097-0139-20
20	20,22,24	alumel	006-1188-20	Red	Red	0.188	4.77	0.033	0.850	0.083	2.10	097-0139-20
20	20,22,24	chromel	006-1131-20	Black		0.188	4.77	0.033	0.850	0.083	2.10	097-0139-20
20	20,22,24	alumel	006-1132-20	Orange		0.188	4.77	0.033	0.850	0.083	2.10	097-0139-20
20	20,22,24	alumel	025-0402-20	Violet	Red	0.188	4.77	0.033	0.850	0.083	2.10	097-0139-20
20	20,22,24	chromel	025-0404-20	Violet	Red	0.188	4.77	0.033	0.850	0.083	2.10	097-0139-20
16	20,22,24	chromel	006-0982-16	None		0.188	4.77	0.047	1.20	0.106	2.70	097-0140-16
16	20,22,24	alumel	006-0983-16	None		0.188	4.77	0.047	1.20	0.106	2.70	097-0140-16
8	6	Power K6*	182-0672-06	Green	Green	0.354	9.00	0.209	5.30	0.224	5.70	182-8004-08A
8	8	Power K6*	182-0672-08	Green	Red			0.161	4.10	0.173	4.40	182-8004-08A
8	10-12	Power K6*	182-0672-10	Green	Brown			0.098	3.50	0.131	3.33	182-8004-08A

*For 18-02, 20-04 & 28-06 inserts only

SOCKETS

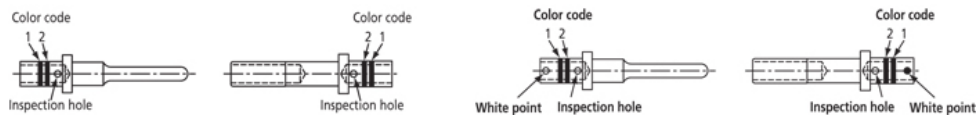

CONTACT SIZE	WIRE CRIMP SIZE RANGE	TYPE	PIN PART NUMBER	COLOR BANDS		WIRE STRIP LENGTHS		WIRE INSULATION SEALING RANGE				WIRE HOLE FILLER
				1	2	IN.	MM	MIN		MAX		
								IN	MM	IN	MM	
20	20,22,24	Standard	006-0937-20A	Red	Red	0.188	4.77	0.033	0.850	0.083	2.10	097-0140-20
20	18,20,22,24	Standard	006-0044-20A	Violet	Red	0.188	4.77	0.033	0.850	0.083	2.10	097-0140-20
20	26,28,30	Standard	006-0972-20	White	Red	0.188	4.77	0.033	0.850	0.083	2.10	097-0140-20
16	16,18,20	Standard	006-0937-16A	Blue	Blue	0.188	4.77	0.047	1.20	0.106	2.70	097-0139-16
16	14,16,18	Standard	006-1102-16	Orange	Blue	0.283	7.18	0.047	1.20	0.106	2.70	097-0139-16
16	20,22,24	Standard	182-0451-16	Red	Blue	0.188	4.77	0.047	1.20	0.106	2.70	097-0139-16
16	26,28,30	Standard	025-0870-16	Black	Blue	0.188	4.77	0.047	1.20	0.106	2.70	097-0139-16
12	12,14	Standard	006-0937-12A	Yellow	Yellow	0.283	7.18	0.075	1.90	0.157	4.00	097-0138-12
20	20,22,24	High-Temperature	097-0015-20	Red	Red	0.188	4.77	0.033	0.850	0.083	2.10	097-0139-20
20	24	High-Temperature	097-0047-20	Blue	Red	0.188	4.77	0.033	0.850	0.083	2.10	097-0139-20
16	16,18,20	High-Temperature	097-0014-16	Blue	Blue	0.283	7.18	0.047	1.20	0.106	2.70	097-0140-16
16	14	High-Temperature	097-0177-16	Blue	Orange	0.283	7.18	0.047	1.20	0.106	2.70	097-0140-16
12	12,14	High-Temperature	097-0165-12	Yellow	Yellow	0.283	7.18	0.075	1.90	0.157	4.00	097-0138-12
20	20,22,24	chromel	006-1186-20	Red	Red	0.188	4.77	0.033	0.850	0.083	2.10	097-0139-20
20	20,22,24	alumel	006-1188-20	Red	Red	0.188	4.77	0.033	0.850	0.083	2.10	097-0139-20
20	20,22,24	chromel	006-1131-20	Black		0.188	4.77	0.033	0.850	0.083	2.10	097-0139-20
20	20,22,24	alumel	006-1132-20	Orange		0.188	4.77	0.033	0.850	0.083	2.10	097-0139-20
20	20,22,24	alumel	025-0402-20	Violet	Red	0.188	4.77	0.033	0.850	0.083	2.10	097-0139-20
20	20,22,24	chromel	025-0404-20	Violet	Red	0.188	4.77	0.033	0.850	0.083	2.10	097-0139-20
16	20,22,24	chromel	006-0982-16	None		0.188	4.77	0.047	1.20	0.106	2.70	097-0140-16
16	20,22,24	alumel	006-0983-16	None		0.188	4.77	0.047	1.20	0.106	2.70	097-0140-16
8	6	Power K6*	182-0672-06	Green	Green	0.354	9.00	0.209	5.30	0.224	5.70	182-8004-08A
8	8	Power K6*	182-0672-08	Green	Red			0.161	4.10	0.173	4.40	182-8004-08A
8	10-12	Power K6*	182-0672-10	Green	Brown			0.098	3.50	0.131	3.33	182-8004-08A

*For 18-02, 20-04 & 28-06 inserts only

PINS

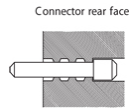

CONTACT SIZE	HAND CRIMP TOOL	TURRET HEAD (LOCATOR)	POWER CRIMP TOOL	POWER TOOL LOCATOR	PLASTIC INSERTION/ EXTRACTION TOOL
20	M22520/1-01	M22520/1-02	WA27F	M22520/1-02	M15570-20
20	M22520/1-01	M22520/1-02	WA27F	M22520/1-02	M15570-20
20	M22520/1-01	M22520/1-02	WA27F	M22520/1-02	M15570-20
16	M22520/1-01	M22520/1-02	WA27F	M22520/1-02	M15570/16
16	M22520/1-01	M22520/1-02	WA27F	M22520/1-02	M15570/16
16	M22520/1-01	M22520/1-02	WA27F	M22520/1-02	M15570/16
16	M22520/1-01	M22520/1-02	WA27F	M22520/1-02	M15570/16
16	M22520/1-01	M22520/1-02	WA27F	M22520/1-02	M15570/16
12	M22520/1-01	M22520/1-02	WA27F	M22520/1-02	M15570-12
20	M22520/1-01	M22520/1-02	WA27F	M22520/1-02	M15570-20
20	M22520/1-01	M22520/1-02	WA27F	M22520/1-02	M15570-20
16	M22520/1-01	M22520/1-02	WA27F	M22520/1-02	M15570-16
16	M22520/1-01	M22520/1-02	WA27F	M22520/1-02	M15570-16
12	M22520/1-01	M22520/1-02	WA27F	M22520/1-02	M15570-12
20	M22520/1-01	M22520/1-02	WA27F	M22520/1-02	M15570-20
20	M22520/1-01	M22520/1-02	WA27F	M22520/1-02	M15570-20
20	M22520/1-01	M22520/1-02	WA27F	M22520/1-02	M15570-20
20	M22520/1-01	M22520/1-02	WA27F	M22520/1-02	M15570-20
20	M22520/1-01	M22520/1-02	WA27F	M22520/1-02	M15570-20
20	M22520/1-01	M22520/1-02	WA27F	M22520/1-02	M15570-20
20	M22520/1-01	M22520/1-02	WA27F	M22520/1-02	M15570-20
16	M22520/1-01	M22520/1-02	WA27F	M22520/1-02	M15570-16
16	M22520/1-01	M22520/1-02	WA27F	M22520/1-02	M15570-16
8	-	-	M22520/23-01	M22520/23-03	025-0711-06
8	-	-	M22520/23-01	M22520/23-03	025-0711-06
8	-	-	M22520/23-01	TP1498	025-0711-06

*For 18-02, 20-04 & 28-06 inserts only

SOCKETS

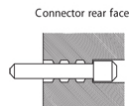

CONTACT SIZE	HAND CRIMP TOOL	TURRET HEAD (LOCATOR)	POWER CRIMP TOOL	POWER TOOL LOCATOR	PLASTIC INSERTION/ EXTRACTION TOOL
20	M22520/1-01	M22520/1-02	WA27F	M22520/1-02	M15570-20
20	M22520/1-01	M22520/1-02	WA27F	M22520/1-02	M15570-20
20	M22520/1-01	M22520/1-02	WA27F	M22520/1-02	M15570-20
16	M22520/1-01	M22520/1-02	WA27F	M22520/1-02	M15570/16
16	M22520/1-01	M22520/1-02	WA27F	M22520/1-02	M15570/16
16	M22520/1-01	M22520/1-02	WA27F	M22520/1-02	M15570/16
16	M22520/1-01	M22520/1-02	WA27F	M22520/1-02	M15570/16
12	M22520/1-01	M22520/1-02	WA27F	M22520/1-02	M15570-12
20	M22520/1-01	M22520/1-02	WA27F	M22520/1-02	M15570-20
20	M22520/1-01	M22520/1-02	WA27F	M22520/1-02	M15570-20
16	M22520/1-01	M22520/1-02	WA27F	M22520/1-02	M15570-16
16	M22520/1-01	M22520/1-02	WA27F	M22520/1-02	M15570-16
12	M22520/1-01	M22520/1-02	WA27F	M22520/1-02	M15570-12
20	M22520/1-01	M22520/1-02	WA27F	M22520/1-02	M15570-20
20	M22520/1-01	M22520/1-02	WA27F	M22520/1-02	M15570-20
20	M22520/1-01	M22520/1-02	WA27F	M22520/1-02	M15570-20
20	M22520/1-01	M22520/1-02	WA27F	M22520/1-02	M15570-20
20	M22520/1-01	M22520/1-02	WA27F	M22520/1-02	M15570-20
20	M22520/1-01	M22520/1-02	WA27F	M22520/1-02	M15570-20
16	M22520/1-01	M22520/1-02	WA27F	M22520/1-02	M15570-16
16	M22520/1-01	M22520/1-02	WA27F	M22520/1-02	M15570-16
8	-	-	M22520/23-01	M22520/23-03	025-0711-06
8	-	-	M22520/23-01	M22520/23-03	025-0711-06
8	-	-	M22520/23-01	TP1498	025-0711-06

*For 18-02, 20-04 & 28-06 inserts only

DIMENSIONS

PLUG - CRIMP TYPE 6

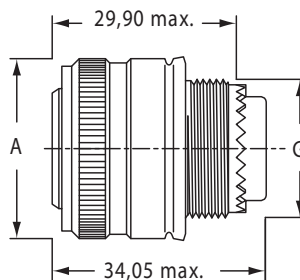

SHELL SIZE	A MAX.	G MAX.	WEIGHT GRAMS*	
			STEEL	ALUMINIUM
08	.839 (21.30)	.500 (12.70)	31	14
10	.980 (24.90)	.624 (15.85)	44	21
12	1.165 (29.60)	.750 (19.05)	57	26
14	1.230 (31.24)	.874 (22.20)	72	38
16	1.276 (32.42)	1.000 (25.40)	82	39
18	1.470 (37.24)	1.061 (26.95)	95	43
20	1.965 (49.91)	1.187 (30.15)	108	48
22	1.735 (44.07)	1.311 (33.30)	121	65
24	1.860 (47.24)	1.437 (36.50)	134	67
28	2.175 (55.24)	1.750 (44.45)	160	103

*Without contacts

SQUARE FLANGE - CRIMP STYLE TYPE 0

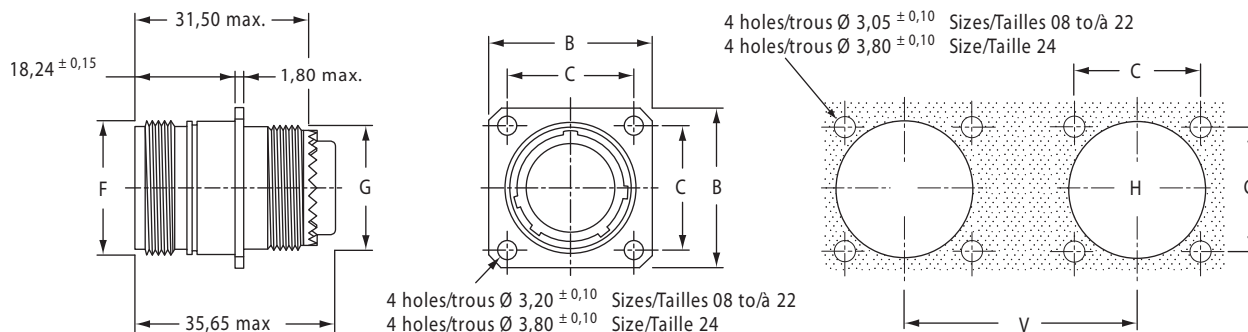

SHELL SIZE	B MAX.	C +/- .002 (+/- .05)	F MAX.	G MAX.	H + 0 / - .001 (+0 / - .02)	V MIN.	WEIGHT GRAMS*	
							STEEL	ALUMINIUM
08	.817 (20.75)	.594 (15.09)	.562 (14.27)	.500 (12.70)	.622 (15.80)	1.248 (31.70)	31	14
10	.942 (23.93)	.719 (18.26)	.688 (17.47)	.625 (15.88)	.736 (18.70)	1.374 (34.90)	44	21
12	1.036 (26.32)	.812 (20.62)	.875 (22.22)	.750 (19.05)	.921 (23.40)	1.559 (39.60)	57	26
14	1.130 (28.71)	.906 (23.01)	.938 (23.82)	.875 (22.23)	.980 (24.90)	1.624 (41.25)	72	38
16	1.255 (31.88)	.969 (24.61)	1.062 (26.97)	1.000 (25.40)	1.114 (28.3)	1.750 (44.45)	82	39
18	1.348 (34.24)	1.050 (26.67)	1.188 (30.18)	1.062 (26.97)	1.224 (31.10)	1.864 (47.35)	95	43
20	1.442 (36.63)	1.156 (29.36)	1.312 (33.32)	1.188 (30.18)	1.358 (34.50)	2.043 (51.90)	108	48
22	1.567 (39.80)	1.250 (31.75)	1.438 (36.53)	1.312 (33.32)	1.476 (37.50)	2.130 (54.10)	121	65
24	1.708 (43.39)	1.375 (34.92)	1.562 (39.67)	1.438 (36.53)	1.598 (40.6)	2.254 (57.25)	134	67
28	2.005 (50.93)	1.562 (39.67)	1.812 (46.02)	1.750 (44.45)	1.890 (48.00)	2.569 (65.25)	160	103

*Without contacts

All dimensions in inches (millimeters in parenthesis)

JAM NUT MOUNTING - CRIMP STYLE TYPE 7

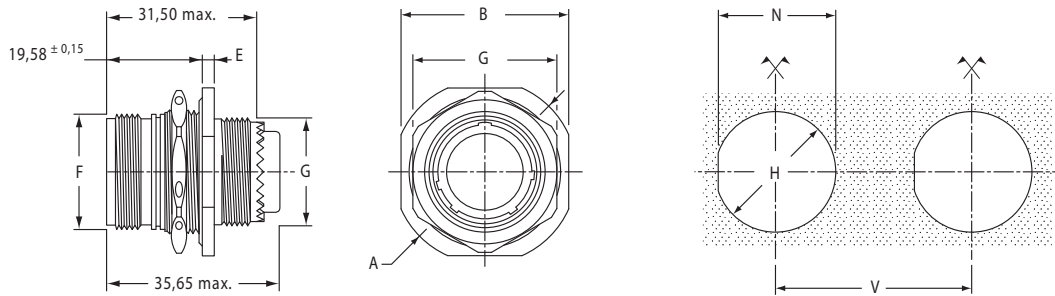

SHELL SIZE	A MAX.	B MAX.	E MAX.	F MAX.	G MAX.	H + 0 / - .001 (+0 / - .02)	M MAX.	N + 0 / - .001 (+0 / - .02)	V MIN.	WEIGHT MAX GRAMS*		TIGHTENING TORQUE OF PANEL NUT
										STEEL	ALUMINIUM	
08	1.078 (27.38)	.980 (24.89)	.137 (3.48)	.562 (14.27)	.500 (12.70)	.640 (16.26)	.829 (21.06)	.610 (15.50)	1.248 (31.70)	32	15	7m.N max.
10	1.192 (30.28)	1.104 (28.04)	.137 (3.48)	.688 (17.47)	.625 (15.88)	.765 (19.43)	.954 (24.23)	.735 (18.67)	1.374 (34.90)	41	21	10m.N max.
12	1.380 (35.05)	1.291 (32.79)	.137 (3.48)	.875 (22.22)	.750 (19.05)	.952 (24.18)	1.142 (29.01)	.922 (23.42)	1.559 (39.60)	58	30	12m.N max.
14	1.516 (38.51)	1.391 (35.33)	.137 (3.48)	.938 (23.82)	.875 (22.23)	1.015 (25.78)	1.205 (30.61)	.985 (25.02)	1.624 (41.25)	68	35	15m.N max.
16	1.641 (41.68)	1.516 (38.51)	.137 (3.48)	1.062 (26.97)	1.000 (25.40)	1.140 (28.96)	1.329 (33.76)	1.110 (28.20)	1.750 (44.45)	82	46	18m.N max.
18	1.766 (44.86)	1.641 (41.68)	.137 (3.48)	1.188 (30.18)	1.062 (26.97)	1.265 (32.13)	1.455 (36.96)	1.230 (31.25)	1.864 (47.35)	88	51	22m.N max.
20	1.954 (49.63)	1.766 (44.86)	.137 (3.48)	1.312 (33.32)	1.188 (30.18)	1.390 (35.31)	1.579 (40.11)	1.355 (34.42)	2.043 (51.90)	100	56	25m.N max.
22	2.078 (52.78)	1.954 (49.63)	.148 (3.76)	1.438 (36.53)	1.312 (33.32)	1.515 (38.48)	1.705 (43.31)	1.480 (37.59)	2.130 (54.10)	123	69	27m.N max.
24	2.182 (55.42)	2.079 (52.81)	.148 (3.76)	1.562 (39.67)	1.438 (36.53)	1.640 (41.66)	1.829 (46.46)	1.605 (40.77)	2.254 (57.25)	137	82	29m.N max.
28	2.434 (61.82)	2.331 (59.21)	.148 (3.76)	1.812 (46.02)	1.750 (44.45)	1.890 (48.01)	2.142 (54.41)	1.856 (47.14)	2.569 (65.25)	191	120	30m.N max.

*Without contacts

SQUARE FLANGE - HERMETIC TYPE 0

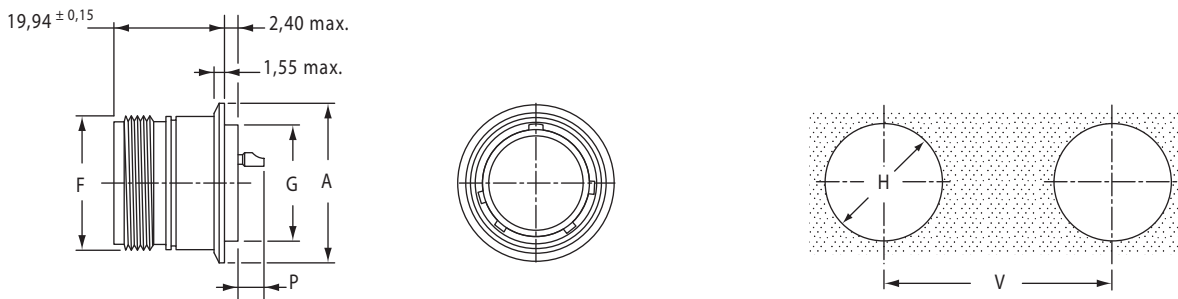

SHELL SIZE	B MAX.	C +/- .002 (+/- .05)	F MAX.	G MAX.	H + 0 / - .001 (+0 / - .02)	P MAX.		V MIN.	WEIGHT MAX. GRAMS*
						SIZE	SIZE		
						20	16-12		
08	.817 (20.75)	.594 (15.09)	.562 (14.27)	.500 (12.70)	.622 (15.80)	.194 (4.93)	.224 (5.69)	1.248 (31.70)	18
10	.942 (23.93)	.719 (18.26)	.688 (17.47)	.625 (15.88)	.736 (18.70)	.194 (4.93)	.224 (5.69)	1.374 (34.90)	24
12	1.036 (26.32)	.812 (20.62)	.875 (22.22)	.750 (19.05)	.921 (23.40)	.194 (4.93)	.224 (5.69)	1.559 (39.60)	31
14	1.130 (28.71)	.906 (23.01)	.938 (23.82)	.875 (22.23)	.980 (24.90)	.194 (4.93)	.224 (5.69)	1.624 (41.25)	40
16	1.255 (31.88)	.969 (24.61)	1.062 (26.97)	1.000 (25.40)	1.114 (28.3)	.194 (4.93)	.224 (5.69)	1.750 (44.45)	49
18	1.348 (34.24)	1.050 (26.67)	1.188 (30.18)	1.062 (26.97)	1.224 (31.10)	.194 (4.93)	.224 (5.69)	1.864 (47.35)	54
20	1.442 (36.63)	1.156 (29.36)	1.312 (33.32)	1.188 (30.18)	1.358 (34.50)	.194 (4.93)	.224 (5.69)	2.043 (51.90)	62
22	1.567 (39.80)	1.250 (31.75)	1.438 (36.53)	1.312 (33.32)	1.476 (37.50)	.194 (4.93)	.224 (5.69)	2.130 (54.10)	77
24	1.708 (43.39)	1.375 (34.92)	1.562 (39.67)	1.438 (36.53)	1.598 (40.60)	.194 (4.93)	.224 (5.69)	2.254 (57.25)	88

*Without contacts

All dimensions in inches (millimeters in parenthesis)

COMPRESSION NUT

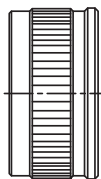

SHELL SIZE	STAINLESS STEEL FOR K-KE-S-SE CLASSES	ALUMINUM NICKEL PLATED FOR R-RS CLASSES	ALUMINUM CADMIUM PLATED FOR W-WS CLASSES	ALUMINUM BLACK ANODIZED PLATED FOR A CLASS
8	66240-08	006-0909-08A499	006-0909-08A838	006-0909-08
10	66240-10	006-0909-10A499	006-0909-10A838	060-0909-10
12	66240-12	006-0909-12A499	006-0909-12A838	060-0909-12
14	66240-14	006-0909-14A499	006-0909-14A838	060-0909-14
16	66240-16	006-0909-16A499	006-0909-16A838	060-0909-16
18	66240-18	006-0909-18A499	006-0909-18A838	060-0909-18
20	66240-20	006-0909-20A499	006-0909-20A838	060-0909-20
22	66240-22	006-0909-22A499	006-0909-22A838	060-0909-22
24	66240-24	006-0909-24A499	006-0909-24A838	060-0909-24
28	66240-28	006-0909-28A499	006-0909-28A838	060-0909-28

STRAIGHT CABLE CLAMP

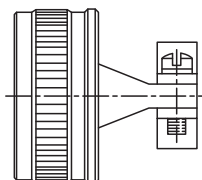

SHELL SIZE	STAINLESS STEEL FOR K-KE-S-SE CLASSES	ALUMINUM NICKEL PLATED FOR R-RS CLASSES	ALUMINUM CADMIUM PLATED FOR W-WS CLASSES	ALUMINUM BLACK ANODIZED PLATED FOR A CLASS
8	66241-08A	006-0910-08A499	006-0910-08A838	006-0910-08
10	66241-10A	006-0910-10A499	006-0910-10A838	006-0910-10
12	66241-12A	006-0910-12A499	006-0910-12A838	006-0910-12
14	66241-14A	006-0910-14A499	006-0910-14A838	006-0910-14
16	66241-16A	006-0910-16A499	006-0910-16A838	006-0910-16
18	66241-18A	006-0910-18A499	006-0910-18A838	006-0910-18
20	66241-20A	006-0910-20A499	006-0910-20A838	006-0910-20
22	66241-22A	006-0910-22A499	006-0910-22A838	006-0910-22
24	66241-24A	006-0910-24A499	006-0910-24A838	006-0910-24
28	66241-28A	006-0910-28A499	006-0910-28A838	006-0910-28

RIGHT ANGLE CABLE CLAMP

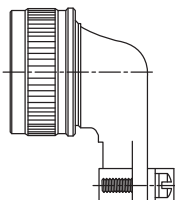

SHELL SIZE	STAINLESS STEEL FOR K-KE-S-SE CLASSES	ALUMINUM NICKEL PLATED FOR R-RS CLASSES	ALUMINUM CADMIUM PLATED FOR W-WS CLASSES	ALUMINUM BLACK ANODIZED PLATED FOR A CLASS
8	66332-08A	006-0908-08A499	006-0908-08A838	006-0908-08
10	66332-10A	006-0908-10A499	006-0908-10A838	006-0908-10
12	66332-12A	006-0908-12A499	006-0908-12A838	006-0908-12
14	66332-14A	006-0908-14A499	006-0908-14A838	006-0908-14
16	66332-16A	006-0908-16A499	006-0908-16A838	006-0908-16
18	66332-18A	006-0908-18A499	006-0908-18A838	006-0908-18
20	66332-20A	006-0908-20A499	006-0908-20A838	006-0908-20
22	66332-22A	006-0908-22A499	006-0908-22A838	006-0908-22
24	66332-24A	006-0908-24A499	006-0908-24A838	006-0908-24
28	66332-28A	006-0908-28A499	006-0908-28A838	006-0908-28

All dimensions in inches (millimeters in parenthesis)

DUSTCAP FOR RECEPTACLES

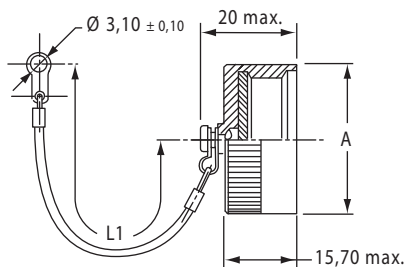

KEYING	STAINLESS STEEL FOR K-KE-S-SE CLASSES	ALUMINUM NICKEL PLATED FOR R-RS CLASSES	ALUMINUM CADMIUM PLATED FOR W-WS CLASSES
N	983-3KE-###	983-3R-###	983-3W-###
6	983-3KE-###	983-3R-###	983-3W-###
7	983-3KE-###	983-3R-###	983-3W-###
8	983-3KE-###	983-3R-###	983-3W-###
9	983-3KE-###	983-3R-###	983-3W-###
Y	983-3KE-###	983-3R-###	983-3W-###

DUSTCAP FOR PLUGS

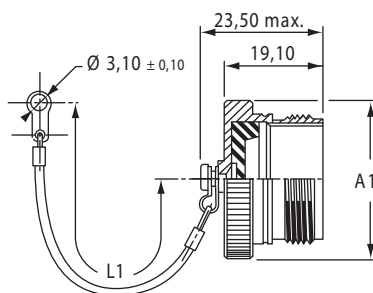

KEYING	STAINLESS STEEL FOR K-KE-S-SE CLASSES	ALUMINUM NICKEL PLATED FOR R-RS CLASSES	ALUMINUM CADMIUM PLATED FOR W-WS CLASSES
N	983-3KE-###	983-3R-###	983-3W-###
6	983-3KE-###	983-3R-###	983-3W-###
7	983-3KE-###	983-3R-###	983-3W-###
8	983-3KE-###	983-3R-###	983-3W-###
9	983-3KE-###	983-3R-###	983-3W-###
Y	983-3KE-###	983-3R-###	983-3W-###

*Choose lanyard type

C = chain and small eyelet

D = cord and small eyelet

N = no chain or cord, with holes for locking wire

= choose shell size

SHELL SIZE	A MAX.		A1 MAX.		L1 +/-6MM (+/- .236)	
	IN.	MM.	IN.	MM.	IN.	MM.
08	0.776	19.70	0.766	19.45	5.00	127
10	0.906	23.00	0.906	23.00	5.00	127
12	1.077	27.35	1.077	27.35	5.00	127
14	1.140	28.95	1.140	28.95	5.00	127
16	1.266	32.15	1.266	32.15	5.00	127
18	1.374	34.90	1.374	34.90	5.00	127
20	1.510	38.35	1.510	38.35	5.00	127
22	1.624	41.25	1.624	41.25	5.00	127
24	1.760	44.70	1.760	44.70	5.00	127
28	2.000	50.80	2.020	51.30	5.00	127

WIRE STRIPPING

Strip insulation from end of wire to be crimped.
(See table for proper stripping dimensions.) Do not cut or damage wire strands.

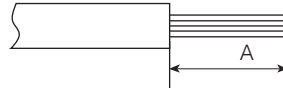

WIRE SIZE	A
20	.157 (4.0) - .197 (5.0)
16	.252 (6.4) - .315 (8.0)
12	.252 (6.4) - .315 (8.0)
8	.336 (8.5) - .372 (9.4)

WIRE STRIPPING AND CONTACT CRIMPING

correct crimp



incorrect crimp



STEP 1: Insert wire into rear of contact. Wire insulation must press against rear of contact. Wire must be visible through inspection hole

STEP 2: M22520 series crimp tool and locator is recommended. → See [Contact and Tooling table on pages 20-21](#)

CONTACT SIZE	COLOR
20	Red
16	Blue
12	Yellow

STEP 3: Insert contact into tool jaws. To crimp, squeeze handles together fully until ratchet releases and allows handles to expand; otherwise, contact may not be extracted from tool jaws. Maintain slight insertion pressure on wire while crimping contact to wire.

CONTACT INSERTION

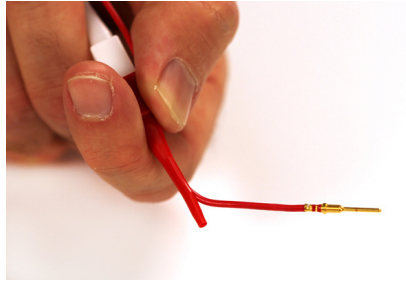

STEP 1: Remove backshell and put wired contacts through cable opening.

STEP 2: Use colored end of plastic insertion / extraction tool for insertion. Place wire and contact into tool so that the tool rests on the rear of the contact shoulder.

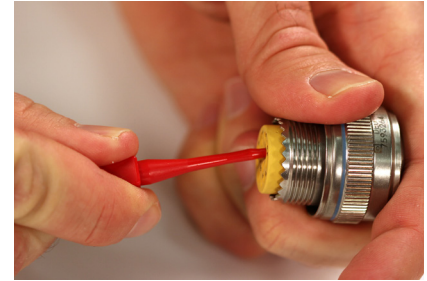

STEP 3: Press tool against contact shoulder and, with firm and even pressure, insert wired contact into center contact cavity.

STEP 4: Remove tool and pull back lightly on wire to make sure contact is properly seated. Repeat operation with remainder of contacts to be inserted, beginning with center cavity and working outward.

STEP 5: After all contacts are inserted, fill any empty cavities with wire sealing plugs. Re-attach backshell and tighten cable clamps.

CONTACT EXTRACTION



STEP 1: Remove backshell from connector and slide back along wire bundle.

STEP 2: Use white end of plastic insertion / extraction tool for extraction. Place tool around wire, and insert tool into contact cavity until tool tip bottoms against the contact shoulder.



STEP 4: Hold firmly onto wire and tool and extract from connector. Repeat operation for all contacts to be extracted.

STEP 5: Fill any empty cavities with wire sealing plugs. Re-attach backshell and tighten cable clamps.

TE Connectivity DEUTSCH AFD Series MIL-DTL-26482 Series II Connectors

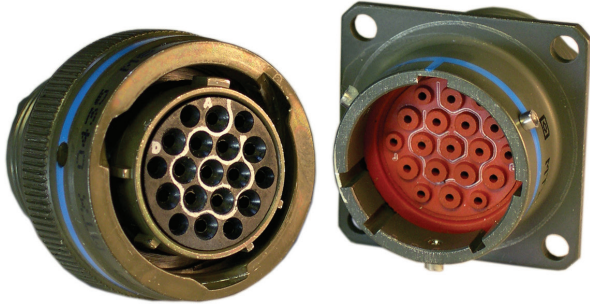

INTERMATEABLE WITH SOURIAU CONNECTORS AND ALL MIL-DTL-26482 SERIES II

TE DEUTSCH AFD series MIL-DTL-26482 series II connectors have a quick-mating, three-point bayonet coupling system. TE DEUTSCH AFD series connectors are designed for harsh environments and are excellent aerospace connectors. These TE DEUTSCH connectors are mil spec to MIL-26482 and have a high-quality contact retention system. The AFD series is intermateable with Souriau connectors and all MIL-DTL-26482 series II connectors. For full product details on the TE DEUTSCH AFD Series MIL-DTL-26482 series II connectors, please see the specifications below.

APPLICATIONS

- High-performance military aircraft
- Commercial aircraft
- Communications equipment
- Armored personnel carriers & tanks
- High temperature industrial equipment

FEATURES

- High-reliability
- Outstanding EMI-shielding protection
- Operates at extreme temperatures
- High-density connectors
- Broad range of military and commercial accessories
- MIL-DTL-26482 qualified

TECHNICAL
SPECIFICATIONS**MATERIALS AND FINISHES**

Shell	Aluminium alloy
Shell Plating	Electroless nickel and olive drab chromate over nickel
Contacts	Copper alloy
Contact Platings	50u" gold plated
Insulator	Rigid plastic dielectric
Seals	Silicone based elastomer

ELECTRICAL DATA

Operating Voltage/Test Voltage

SERVICE RATING	WORKING		TEST	
	SEA LEVEL VAC RMS	70000 FEET ALTITUDE VAC RMS	SEA LEVEL VAC RMS	70000 FEET ALTITUDE VAC RMS
I	600	300	1500	375
II	1000	450	2300	500

Current Rating

WIRE SIZE	CONTACT SIZE	MAX. CURRENT FOR TEST IN AMPS	POTENTIAL DROP MILLIVOLT AT 77F (25C)
24	20	3	<45
20	20	7.5	<55
20	16	7.5	<45
16	16	13	<50
14	12	17	<45
12	12	23	<50

MECHANICAL DATA

Wire Range Sizes	12-24AWG
Insulation Resistance	5000 Megaohms minimum at 77°F (25°C) 500 Megaohm minimum at 392°F (200°C) Class L and 347°F (175°C) Class W
Mating Life	500 cycle minimum, 250 cycle minimum for shielded plug
Salt Spray	Class L & W 48 hours unmated; 452 hours mated per MIL-STD-1344 method, 1001 per MIL-DTL-26482
Heat	Class L +392°F (200°C), Class W 347°F (175°C) for 1000 hours to MIL-STD-1344 method 1005.1
Chemical Resistance	Tested unmated according to MIL-DTL-26482 44.6.28 for hydraulic fluid, lubricating oil, deicing fluids, jet fuels, solvents and coolants
Vibration	10 to 2000Hz (20g's) 10 microseconds maximum discontinuity. To MIL-STD-1344 method 2005 per MIL-DTL-26482
Shock	150g's 6 microseconds duration, three major axes. 10 microsecond maximum discontinuity

MECHANICAL DATA (CONT.)

Contact Type	Crimp, coax, shielded, printed circuit board, thermocouple, and fiber optic
Number of Circuits	3 to 61
Polarization	Five keyway, three point bayonet with optional rotational polarization
Approvals/Agency Listing	MIL-DTL-26482

Wire Sealing Range

CONTACT SIZE	WIRE SEALING RANGE MIN. INCH (MM)	WIRE SEALING RANGE MAX. INCH (MM)
20	.040 (1.02)	.083 (2.11)
16	.053 (1.35)	.103 (2.62)
12	.097 (2.46)	.158 (4.01)

Contact Retention

CONTACT SIZE	RETENTION AXIAL LOAD LBS.	SEPARATION FORCE MINIMUM (INITIAL) OUNCES
20	.040 (1.02)	.083 (2.11)
16	.053 (1.35)	.103 (2.62)
12	.097 (2.46)	.158 (4.01)

All dimensions in inches (millimeters in parenthesis)

HOW TO ORDER 26482 SERIES CONNECTORS - MILITARY

1	2	3	4	5	6
MS3470	L	24-61	P	W	-LC
SHELL STYLE	FINISH	LAYOUT	CONTACT	POLARIZATION	MODIFIER

(Military part number example)

STEP 1: SELECT SHELL STYLE, PLUG OR RECEPTACLE



*Not available in Size 8

STEP 2: SELECT FINISH

L = Electroless Nickel

W = Olive Drab Chromate over Cadmium over Nickel 500 Hour Salt Spray

STEP 3: SELECT LAYOUT

⇒ See page 36 for listing by # of contacts

LAYOUT	SERVICE RATING	TOTAL	20	16	12	ROTATIONS			
						W	X	Y	Z
8-98	I	3	3			60	210		
8-33	I	3	3			90			
10-6	I	6	6			90			
12-3	II	3		3				180	
12-8	I	8	8			90	112	203	292
12-10	I	10	10			60	155	270	295
14-4	I	4			4				
14-5	II	5		5		40	92	184	273
14-12	I	12	8	4		43	90		
14-15	I	15	14	1		17	110	155	234
14-18	I	18	18			15	90	180	331
14-19	I	19	19			30	165	315	
16-8	II	8		8		54	152	180	331
16-26	I	26	26			60	105	275	338
18-8	I	8			8				
18-11	II	11		11		62	119	241	340
18-30	I	30	29	1		180	193	285	350
18-32	I	32	32			85	138	222	265
20-16	II	16		16		238	318	333	347
20-39	I	39	37	2		63	144	252	333
20-41	I	41	41			45	126	225	
22-12	I	12			12				
22-21	II	21		21		16	135	175	349
22-32	I	32	32			72	145	215	288
22-41	I	41	27	14		39	135	264	
22-55	I	55	55			30	142	226	314
24-19	II	19			19	30	165	315	
24-31	I	31		31		90	225		
24-61	I	61	61			90	180	270	324

STEP 4: SELECT CONTACT

- P** = Pin
- S** = Socket
- Note:** See Step 6 if you are not ordering contacts with part.
- A** = Less Pin Contacts
- B** = Less Socket Contact
- Note:** The "A" and "B" designators may be used when other than power contacts (PCB, Coax, Thermocouple, or Fiber Optic contacts)

STEP 5: SELECT POLARIZATION

(omit for normal)
W
X
Y
Z

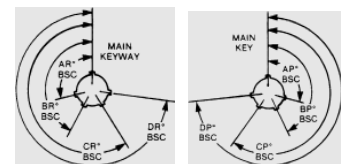

Receptacle

Plug

STEP 6: SELECT MODIFIER

Omit for standard contacts
-LC = for use with standard contacts, but supplied without contacts, seal plugs or tools (PO must state Less Contacts)

Note: -LC is not marked on part

HOW TO ORDER 26482 SERIES CONNECTORS - COMMERCIAL

1	2	3	4	5	6
AFD50-	24-61	P	W	-6117	-LC
SHELL STYLE	LAYOUT	CONTACT	POLARIZATION	FINISH	MODIFIER

(Commercial part number example)

STEP 1: SELECT SHELL STYLE, PLUG OR RECEPTACLE

RECEPTACLES ← Mates with → PLUGS



AFD50
Narrow Flange Receptacle



AFD51
Cable Receptacle*



AFD56
Standard Plug



AFD58
Wide Flange Receptacle*



AFD54
Jam Nut Receptacle*



AFD57
Shielded Plug

*Not available in Size 8

STEP 2: SELECT LAYOUT

⇒ See page 36 for listing by # of contacts

LAYOUT	SERVICE RATING	TOTAL	20	16	12	8 OR COAX	ROTATIONS			
							W	X	Y	Z
8-98	I	3	3				60	210		
8-33	I	3	3				90			
8-3A	I	3	3				60			
10-6	I	6	6				90			
12-3	II	3		3					180	
12-8	I	8	8				90	112	203	292
12-10	I	10	10				60	155	270	295
14-4	I	4			4					
14-5	II	5		5			40	92	184	273
14-12	I	12	8	4			43	90		
14-15	I	15	14	1			17	110	155	234
14-18	I	18	18				15	90	180	331
14-19	I	19	19				30	165	315	
16-8	II	8		8			54	152	180	331
16-26	I	26	26				60	105	275	338
18-8	I	8			8					
18-11	II	11		11			62	119	241	340
18-30	I	30	29	1			180	193	285	350
18-32	I	32	32				85	138	222	265
18-918		18	16			2				
20-16	II	16		16			238	318	333	347
20-39	I	39	37	2			63	144	252	333
20-41	I	41	41				45	126	225	
22-12	I	12			12					
22-21	II	21		21			16	135	175	349
22-32	I	32	32				72	145	215	288
22-41	I	41	27	14			39	135	264	
22-55	I	55	55				30	142	226	314
24-19	II	19			19		30	165	315	
24-31	I	31		31			90	225		
24-37	I	37		37			25	50	75	
24-53	I	53	51			2				
24-61	I	61	61				90	180	270	324
24-100		10				10	45	90	135	

STEP 3: SELECT CONTACT



P = Pin
S = Socket

Note: See Step 6 if you are not ordering contacts with part.

A = Less Pin Contacts

B = Less Socket Contact

Note: The "A" and "B" designators may be used when other than power contacts (PCB, Coax, Thermocouple, or Fiber Optic contacts)

STEP 4: SELECT POLARIZATION



(omit for normal)

W
X
Y
Z

STEP 5: SELECT FINISH



-1A = Aluminium Shell, nickel, no endbell

-6117 = Aluminium Shell, olive drab cadmium plated, no endbell

-6116 = Aluminium Shell, black anodized, no endbell

-059 = Aluminum Shell, nickel-plated with typical straight cable clamp

-Blank = Aluminum Shell, nickel-plated with grommet nut

STEP 6: SELECT MODIFIER



For other commercial modification, i.e., less tools, with pc contact or with endbell, call.

Omit for standard contacts

-LC = for use with standard contacts, but supplied without contacts, seal plugs or tools (PO must state Less Contacts)

Note: -LC is not marked on part

LAYOUTS BY SHELL SIZE

○ 20 ● 16 ◐ 12

LAYOUT	8-33	8-98	10-6	12-3	12-8	12-10	14-4	14-5
# OF CONTACTS	3-#20	3-#20	6-#20	3-#16	8-#20	10-#20	4-#12	4-#16
SERVICE RATING	I	I	I	II	I	I	I	II

LAYOUT	14-12	14-15	14-18	14-19	16-8	16-26	18-8	18-11
# OF CONTACTS	8-#20, 4-#16	14-#20, 1-#16	18-#20	19-#20	8-#16	26-#20	8-#12	11-#16
SERVICE RATING	I	I	I	I	II	I	I	II

LAYOUT	18-30	18-32	20-16	20-39	20-41	22-12
# OF CONTACTS	29-#20, 1-#16	32-#20	16-#16	37-#20, 2-#16	41-#20	12-#12
SERVICE RATING	I	I	II	I	I	I

LAYOUT	22-21	22-41	22-55	24-19	24-31	24-61
# OF CONTACTS	21-#16	27-#20, 14-#16	55-#20	19-#12	31-#16	61-#20
SERVICE RATING	II	I	I	II	I	I

PINS

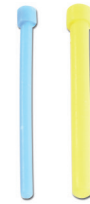
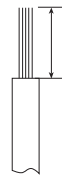

Insert head first, trim excess

CONTACT SIZE	WIRE CRIMP SIZE RANGE	PIN PART NUMBER	COLOR BANDS			WIRE STRIP LENGTHS		WIRE INSULATION SEALING RANGE				WIRE HOLE FILLER	WIRE HOLE FILLER COLOR
			1	2	3	IN.	MM	MIN. IN.	MIN. MM	MAX. IN.	MAX. MM		
20	20,22,24	M39029/4-110	Brown	Brown	Black	Brown	Brown	0.04	1.02	0.083	2.11	MS27488-20-2	Red
16	16,18,20	M39029/4-111	Brown	Brown	Brown	Brown	Brown	0.053	1.35	0.103	2.62	MS27488-16-2	Blue
12	12 & 14	M39029/4-113	Brown	Brown	Orange	Brown	Brown	0.097	2.46	0.158	4.01	MS27488-12-2	Yellow
8	Contact us for details.												

SOCKETS

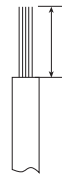

Insert head first, trim excess

CONTACT SIZE	WIRE CRIMP SIZE RANGE	SOCKET PART NUMBER	COLOR BANDS			WIRE STRIP LENGTHS		WIRE INSULATION SEALING RANGE				WIRE HOLE FILLER	WIRE HOLE FILLER COLOR
			1	2	3	IN.	MM	MIN. IN.	MIN. MM	MAX. IN.	MAX. MM		
20	20,22,24	M39029/5-115	Brown	Brown	Green	0.1875	4.77	0.04	1.02	0.083	2.11	MS27488-20-2	Red
16	16,18,20	M39029/5-116	Brown	Brown	Blue	0.2812	7.14	0.053	1.35	0.103	2.62	MS27488-16-2	Blue
12	12 & 14	M39029/5-118	Brown	Brown	Grey	0.2812	7.14	0.097	2.46	0.158	4.01	MS27488-12-2	Yellow
8	Contact us for details.												

CONTACT TOOLS

PINS

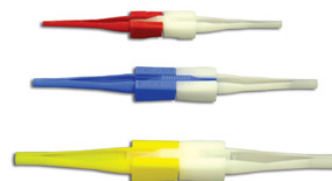

CONTACT SIZE	HAND CRIMP TOOL	TURRET HEAD (LOCATOR)	TURRET HEAD (LOCATOR) COLOR	POWER CRIMP TOOL	POWER TOOL LOCATOR	METAL		PLASTIC		
						INSERTION TOW	EXTRACTION TOOL	INSERTION/ EXTRACTION TOOL	INSERTION TIP COLOR	EXTRACTION TIP COLOR
20	M22520/1-01	M22520/1-02	Red	WA27F	M22520/1-02	DAK83-20B	DRK83-20B	M81969/14-11	Red	White
16	M22520/1-01	M22520/1-02	Blue	WA27F	M22520/1-02	DAK83-16B	DRK83-16B	M81969/14-03	Blue	White
12	M22520/1-01	M22520/1-02	Yellow	WA27F	M22520/1-02	DAK83-12B	DRK83-12B	M81969/14-04	Yellow	White
8	Contact us for details.									

SOCKETS

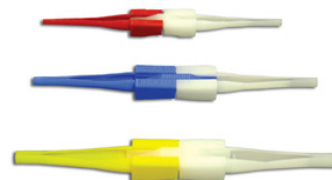

CONTACT SIZE	HAND CRIMP TOOL	TURRET HEAD (LOCATOR)	TURRET HEAD (LOCATOR) COLOR	POWER CRIMP TOOL	POWER TOOL LOCATOR	METAL		PLASTIC		
						INSERTION TOW	EXTRACTION TOOL	INSERTION/ EXTRACTION TOOL	INSERTION TIP COLOR	EXTRACTION TIP COLOR
20	M22520/1-01	M22520/1-02	Red	WA27F	M22520/1-02	DAK83-20B	DRK83-20B	M81969/14-11	Red	White
16	M22520/1-01	M22520/1-02	Blue	WA27F	M22520/1-02	DAK83-16B	DRK83-16B	M81969/14-03	Blue	White
12	M22520/1-01	M22520/1-02	Yellow	WA27F	M22520/1-02	DAK83-12B	DRK83-12B	M81969/14-04	Yellow	White
8	Contact us for details.									

All dimensions in inches (millimeters in parenthesis)

PLUGS

MS3476/ AFD56 & MS3475/ AFD57

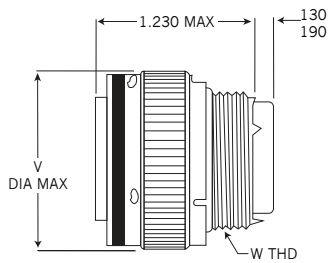

SHELL SIZE	V DIA. MAX.	W THREAD CLASS 2A
8	0.782 (19.86)	.5000-20 UNF
10	0.926 (23.52)	.6250-24 UNEF
12	1.043 (26.49)	.7500-20 UNEF
14	1.183 (30.04)	.8750-20 UNEF
16	1.305 (33.14)	1.000-20 UNEF
18	1.391 (35.33)	1.0625-18 UNEF
20	1.531 (38.88)	1.1875-18 UNEF
22	1.656 (42.06)	1.3125-18 UNEF
24	1.777 (45.13)	1.4375-18 UNEF

FLANGE MOUNT

MS3470/ AFD50 & MS3472/ AFD58

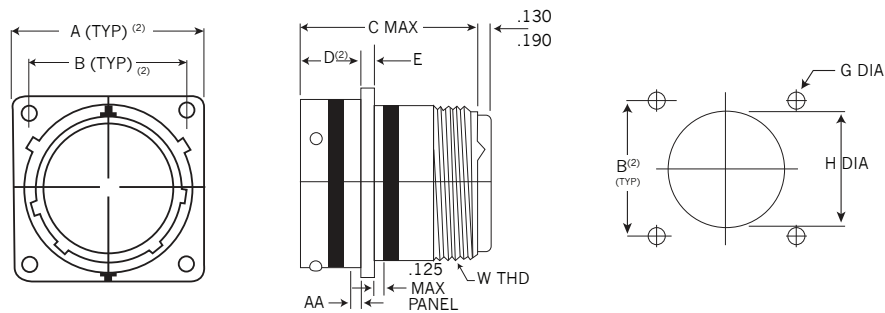

SHELL SIZE	AA MAX. PANEL THICKNESS		A MAX.		B +/- .005 (+/- 1.27)		C MAX.	D		E +/- .016 (+/- .406)	W THREAD CLASS 2A
	MS3470/ AFD50	MS3474/ AFD58	MS3470/ AFD50	MS3470/ AFD50	MS3470/ AFD50	MS3474/ AFD58		MS3470/ AFD50	MS3474/ AFD58		
8	.087 (2.21)	.118 (3.00)	.828 (21.0)	1.065 (27.1)	.594 (15.1)	.734 (18.6)	1.215 (30.86)	.462/.431 (11.74/10.95)	.493/.462 (12.52/11.73)	.062 (1.6)	.5000-20 UNF
10	.087 (2.21)	.118 (3.00)	.954 (24.2)	1.141 (29.0)	.719 (18.3)	.812 (20.6)	1.215 (30.86)	.462/.431 (11.74/10.95)	.493/.462 (12.52/11.73)	.062 (1.6)	.6250-24 UNEF
12	.087 (2.21)	.118 (3.00)	1.047 (26.6)	1.266 (32.2)	.812 (20.6)	.938 (23.8)	1.215 (30.86)	.462/.431 (11.74/10.95)	.493/.462 (12.52/11.73)	.062 (1.6)	.7500-20 UNEF
14	.087 (2.21)	.118 (3.00)	1.141 (29.0)	1.360 (34.5)	.906 (23.0)	1.031 (26.2)	1.215 (30.86)	.462/.431 (11.74/10.95)	.493/.462 (12.52/11.73)	.062 (1.6)	.8750-20 UNEF
16	.087 (2.21)	.118 (3.00)	1.234 (31.3)	1.453 (36.9)	.969 (24.6)	1.125 (28.6)	1.215 (30.86)	.462/.431 (11.74/10.95)	.493/.462 (12.52/11.73)	.062 (1.6)	1.000-20 UNEF
18	.087 (2.21)	.118 (3.00)	1.328 (33.7)	1.532 (38.9)	1.062 (27.0)	1.203 (30.6)	1.215 (30.86)	.462/.431 (11.74/10.95)	.493/.462 (12.52/11.73)	.062 (1.6)	1.0625-18 UNEF
20	.212 (5.38)	.212 (5.38)	1.453 (36.9)	1.688 (42.9)	1.156 (29.4)	1.297 (32.9)	1.275 (32.39)	.587/.556 (14.91/14.12)	.587/.556 (14.91/14.12)	.094 (2.4)	1.1875-18 UNEF
22	.212 (5.38)	.212 (5.38)	1.578 (40.1)	1.766 (44.9)	1.250 (31.8)	1.375 (34.9)	1.275 (32.39)	.587/.556 (14.91/14.12)	.587/.556 (14.91/14.12)	.094 (2.4)	1.3125-18 UNEF
24	.212 (5.38)	.212 (5.38)	1.703 (43.3)	1.891 (48.0)	1.375 (34.9)	1.500 (38.1)	1.275 (32.39)	.587/.556 (14.91/14.12)	.587/.556 (14.91/14.12)	.094 (2.4)	1.4375-18 UNEF

All dimensions in inches (millimeters in parenthesis)

JAM NUT RECEPTACLE

MS3474/ AFD74

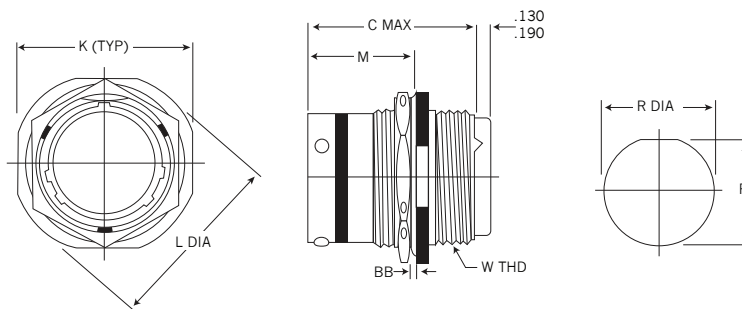

SHELL SIZE	BB MAX. PANEL	K +/- .016 (+/- .394)	L +/- .016 (+/- .394)	M +/- .008 (+/- .203)	C MAX.	W THREAD CLASS 2A
8	.187 (4.75)	.939 (23.84)	1.063 (26.99)	.699 (17.75)	1.215 (30.86)	.5000-20 UNF
10	.187 (4.75)	1.0625 (26.99)	1.188 (30.16)	.699 (17.75)	1.215 (30.86)	.6250-24 UNEF
12	.187 (4.75)	1.251 (31.76)	1.378 (34.94)	.699 (17.75)	1.215 (30.86)	.7500-20 UNEF
14	.187 (4.75)	1.378 (34.94)	1.501 (38.11)	.699 (17.75)	1.215 (30.86)	.8750-20 UNEF
16	.187 (4.75)	1.501 (38.11)	1.626 (41.29)	.699 (17.75)	1.215 (30.86)	1.000-20 UNEF
18	.187 (4.75)	1.626 (41.29)	1.751 (44.46)	.699 (17.75)	1.215 (30.86)	1.0625-18 UNEF
20	.250 (6.35)	1.813 (46.04)	1.939 (49.24)	.763 (19.38)	1.275 (32.39)	1.1875-18 UNEF
22	.250 (6.35)	1.939 (49.24)	2.063 (52.39)	.763 (19.38)	1.275 (32.39)	1.3125-18 UNEF
24	.219 (5.56)	2.063 (52.39)	2.188 (55.56)	.763 (19.38)	1.275 (32.39)	1.4375-18 UNEF

IN-LINE CABLE RECEPTACLE

MS3471/ AFD51

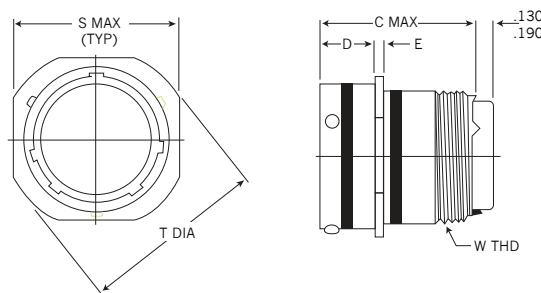

SHELL SIZE	S MAX.	T +/- .040 (+/- .508)	C MAX.	D	E +/- .016 (+/- .406)	W THREAD CLASS 2A
				MS3471/AFD51		
8	.828 (21.03)	.938 (23.83)	1.215 (30.86)	.462/.431 (11.74/10.95)	.062 (1.6)	.5000-20 UNF
10	.954 (24.23)	1.062 (26.97)	1.215 (30.86)	.462/.431 (11.74/10.95)	.062 (1.6)	.6250-24 UNEF
12	1.047 (26.59)	1.156 (29.36)	1.215 (30.86)	.462/.431 (11.74/10.95)	.062 (1.6)	.7500-20 UNEF
14	1.141 (28.98)	1.250 (31.75)	1.215 (30.86)	.462/.431 (11.74/10.95)	.062 (1.6)	.8750-20 UNEF
16	1.234 (31.34)	1.344 (34.14)	1.215 (30.86)	.462/.431 (11.74/10.95)	.062 (1.6)	1.000-20 UNEF
18	1.328 (33.73)	1.438 (36.53)	1.215 (30.86)	.462/.431 (11.74/10.95)	.062 (1.6)	1.0625-18 UNEF
20	1.453 (36.91)	1.562 (39.67)	1.275 (32.39)	.587/.556 (14.91/14.12)	.094 (2.4)	1.1875-18 UNEF
22	1.578 (40.08)	1.688 (42.88)	1.275 (32.39)	.587/.556 (14.91/14.12)	.094 (2.4)	1.3125-18 UNEF
24	1.703 (43.26)	1.812 (46.02)	1.275 (32.39)	.587/.556 (14.91/14.12)	.094 (2.4)	1.4375-18 UNEF

All dimensions in inches (millimeters in parenthesis)

DUMMY RECEPTACLES, DUST CAPS & PLUG CAPS



SHELL SIZE	DUMMY RECEPTACLES OLIVE DRAB OVER CADMIUM PLATED	METAL DUSTCAP		
		FOR PLUGS	FOR RECEPTACLE	
			FLANGED WITH SASH CHAIN	JAM NUT WITH SASH CHAIN AND RING
8	MS3115-8	MS3180-8C*	MS3181-8C*	MS3181-8N*
10	MS3115-10	MS3180-10C*	MS3181-10C*	MS3181-10N*
12	MS3115-12	MS3180-12C*	MS3181-12C*	MS3181-12N*
14	MS3115-14	MS3180-14C*	MS3181-14C*	MS3181-14N*
16	MS3115-16	MS3180-16C*	MS3181-16C*	MS3181-16N*
18	MS3115-18	MS3180-18C*	MS3181-18C*	MS3181-18N*
20	MS3115-20	MS3180-20C*	MS3181-20C*	MS3181-20N*
22	MS3115-22	MS3180-22C*	MS3181-22C*	MS3181-22N*
24	MS3115-24	MS3180-24C*	MS3181-24C*	MS3181-24N*

*Default Plating = Olive Drab over Cadmium
A = Anodized

STANDARD CABLE CLAMPS

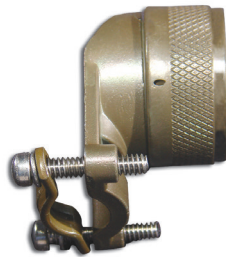







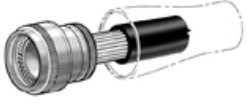

SHELL SIZE	STRAIGHT CLAMP		90°		CABLE ENTRY	
	LOW COST	SELF-LOCKING	LOW COST	SELF-LOCKING	MAX	MIN
8	M85049/52-1-8*	M85049/52S8*	M85049/51-1-8*	M85049/51S8*	.204 (5.18)	.125 (3.18)
10	M85049/52-1-10*	M85049/52S10*	M85049/51-1-10*	M85049/51S10*	.286 (7.26)	.187 (4.75)
12	M85049/52-1-12*	M85049/52S12*	M85049/51-1-12*	M85049/51S12*	.416 (10.57)	.291 (7.39)
14	M85049/52-1-14*	M85049/52S14*	M85049/51-1-14*	M85049/51S14*	.476 (12.09)	.351 (8.92)
16	M85049/52-1-16*	M85049/52S16*	M85049/51-1-16*	M85049/51S16*	.625 (15.88)	.501 (12.72)
18	M85049/52-1-18*	M85049/52S18*	M85049/51-1-18*	M85049/51S18*	.706 (17.93)	.518 (13.16)
20	M85049/52-1-20*	M85049/52S20*	M85049/51-1-20*	M85049/51S20*	.831 (21.11)	.581 (14.76)
22	M85049/52-1-22*	M85049/52S22*	M85049/51-1-22*	M85049/51S22*	.956 (24.28)	.644 (16.36)
24	M85049/52-1-24*	M85049/52S24*	M85049/51-1-24*	M85049/51S24*	1.081 (27.46)	.706 (17.93)

*Select plating code to match connector plating
N = Electroless nickel
W = Olive drab chromate over cadmium over electroless nickel (500-hour salt spray)

All dimensions in inches (millimeters in parenthesis)

STANDARD CABLE CLAMPS

	DESCRIPTION	PART NUMBER PREFIX	STRAIGHT	90°	45°
	Heat Shrink Boot Adapter	M85049/60	X		
	Environmental	M85049/7			X
		M85049/9		X	
		M85049/11	X		
	EMI/RFI Non- Environmental	M85049/23			X
		M85049/24		X	
		M85049/25	X		
	EMI/RFI Environmental	M85049/6			X
		M85049/8		X	
		M85049/10	X		
	EMI/RFI Crimp Ring	M85049/26	X		
	EMI/RFI Banding	M85049/82	X		
		M85049/83			X
		M85049/84		X	
	Cable Tie	M85049/55		X	
		M85049/53	X		
		M85049/54			X
	Wire Seal Compression Nuts "E"	M85049/31	X		

NOTE: If military-standard versions won't work for your applications, please contact us with your requirements.

WIRE STRIPPING AND CONTACT CRIMPING

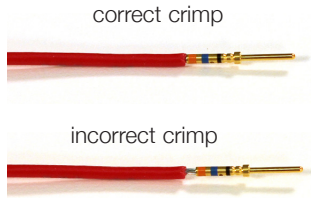

STEP 1: Strip wires. See above for correct strip length for contact. Insert wire into rear of contact. Wire insulation must push against rear of contact. Wire must be visible through inspection hole.

STEP 2: Use M22520/1-01 crimp tool with proper crimp locator M22520/1-02.

CONTACT SIZE	COLOR
20	Red
16	Blue
12	Yellow

STEP 3: Insert contact and wire into tool jaws. To crimp, squeeze handles together fully until ratchet releases and allows handles to expand; otherwise, contact cannot be extracted from tool jaws. Maintain slight insertion pressure on wire while crimping contact to wire.*

*IMPORTANT NOTE: Microsection the contact to verify crimp quality.

CONTACT INSERTION

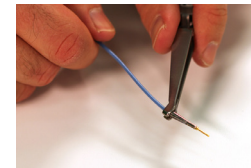
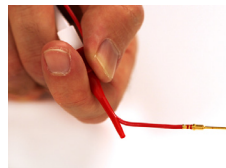
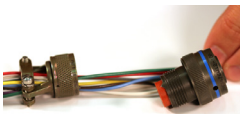

STEP 1: Remove backshell and put wired contacts through cable clamp opening.

STEP 2: Use colored end of CIET tool for insertion. Place wire into tool at large opening. To facilitate contact insertion, a minimum six inches of free wire is recommended.

STEP 3: Slide tool on wire while holding thumb against wire at opening. Wire will slip into tool.

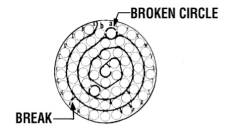
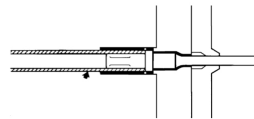

STEP 4: With tool pressed against shoulder of contact, starting at the center cavity, insert wired contact and tool into properly-identified cavity at rear of plug with firm, even pressure. Do not use excessive pressure.

STEP 5: When contact bottoms, a slight click can be heard as tines of metal retaining clip snap into place behind contact shoulder.

STEP 6: Check face of plug or receptacle for proper contact installation. In socket inserts with a large number of contacts, cavities are identified in a spiral pattern. A projecting line from the spiral indicates omission of a letter; a broken circle around a cavity indicates transition between capitals, lower case and double letters.



STEP 7: Withdraw tool from rear of plug. To be sure that contact is locked, pull back lightly on wire. Then remove tool from wire and proceed with other contacts.

STEP 8: After all contacts are inserted, fill unwired cavities with sealing plugs (insert head first and leave end protruding for ease of removal), assemble backshell on rear of connector.

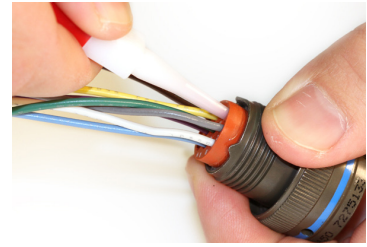
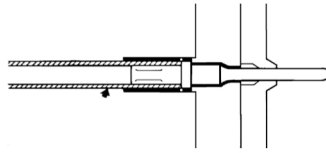
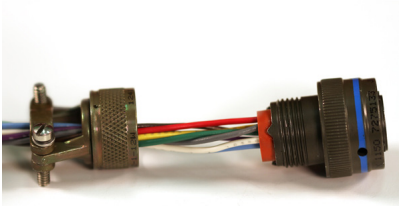

STEP 1: Remove backshell and slide along wires to allow access. To extract a contact, use white end of CIET tool. Place wire into tool at large opening. Slide back tool on wire while holding thumb against wire at opening. Wire will slip into tool.

STEP 2: Push tool into rear of plug until it bottoms. At this point, tool releases tines on retaining clip so that contact can be extracted.

STEP 3: While maintaining slight insertion force on tool, firmly hold wire against serrated shoulder at center of tool and extract both wired contact and tool from plug.

*IMPORTANT NOTE: Microsection the contact to verify crimp quality.

TE Connectivity DEUTSCH DJT Series MIL-DTL-38999 Series I Connectors



INTERMATEABLE WITH SOURIAU CONNECTORS AND ALL MIL-DTL-38999 SERIES I

TE DEUTSCH DJT series MIL-DTL-38999 series I connectors offer high density contact arrangements in a miniature metal circular connector. DJT connectors meet MIL-38999 and were originally designed as military and aerospace components. The TE DEUTSCH DJT series is now being used in many applications requiring extremely reliable interconnections. These TE DEUTSCH connectors are quick-mating, environmentally-sealed, triple-lead threaded, have a self-locking coupling, and are EMI-RFI-shielded. A variety of D38999 backshells are available. For full product details on the TE DEUTSCH DJT series MIL-DTL-38999 series I connectors, please see the specifications below.

APPLICATIONS

- High-performance military aircraft
- Commercial aircraft
- Communications equipment
- Armored personnel carriers & tanks
- High temperature industrial equipment
- Missiles
- Shipboard

FEATURES

- High Reliability
- Outstanding EMI/RFI Shielding Protection
- High Density
- Self Locking Connector Systems
- MIL-DTL-38999
- Scoop-Proof Contact Protection

MATERIALS AND FINISHES

Shell	Aluminium alloy
Bayonet Pins	Passivated stainless steel per QQ-S-763
Shell Plating	Electroless nickel and olive drab chromate over nickel
Contacts	Copper alloy
Contact Platings	50u" gold plated
Insulator	Rigid plastic dielectric
Seals	Fluorinated silicone based elastomer
Grounding Springs	Beryllium copper

ELECTRICAL DATA

Wire Range Sizes	12-28AWG
Insulation Resistance	5000 Megaohms minimum at 77°F (25°C)

Contact Resistance of mated contacts end to end

CONTACT SIZE	MAXIMUM MILLIVOLT DROP
22D	40
20	35
16	25
12	25

Test Voltage ac rms

SERVICE RATING	SEA LEVEL		100,000 FEET ALTITUDE	
	MATED	UNMATED	MATED	UNMATED
M	1300	1300	800	200
N	1000	1000	600	200
I	1800	1800	1000	200
II	2300	2300	1000	200

Current Rating

WIRE SIZE	CONTACT SIZE	MAX. CURRENT FOR TEST IN AMPS	POTENTIAL DROP MILLIVOLT AT 77°F (25°C)
24	20	3	<45
20	20	7.5	<55
20	16	7.5	<45
16	16	13	<50
14	12	17	<45
12	12	23	<50

MECHANICAL DATA

Operating Temperature	B - Olive Drab -65°C to +175°C (-85°F to +347°F) F - Electroless Nickel -65°C to +200°C (-85°F to +392°F)
Sealing	Against sand, dust per MIL-STD-202 & ice resistance

Wire Sealing Range

CONTACT SIZE	MINIMUM		MAXIMUM	
	INCHES	MM	INCHES	MM
22D	0.030	0.76	0.054	1.37
20	0.040	1.02	0.83	2.11
16	0.065	1.65	0.109	2.77
12	0.097	2.46	0.142	3.61
8 (Coax)	0.135	3.43	0.155	3.94
8 (Twinax)	0.124	3.15	0.134	3.4

Insulation Strip Length

CONTACT SIZE	STRIP LENGTH	
	INCHES	MM
22D	0.125	3.18
20	0.188	4.77
16	0.188	4.77
12	0.188	4.77

Mating Life	500 mating cycle
Salt Spray	B - Olive Drab, 500 hours per MIL-STD-1344A method 1001 condition C F - Electroless Nickel, 48 hours per MIL-STD-1344A method 1001 condition B
Temp Durability	B - Olive Drab -65°C to +175°C (-85°F to +347°F) F - Electroless Nickel -65°C to +200°C (-85°F to +392°F)
Chemical Resistance	Lubricating oils, hydraulic fluids, coolants, deicing fluids per MIL-STD-1344A Method 1016 condition a-1
Sine Vibration	60g at -55°C per MIL-DTL-38999L 4.5.23.2.1
Random Vibration	49.5 grms at ambient temperatures
Shock	300 grms
EMI Shielding Effectiveness	100 MHz to 10 GHz - minimum attenuation of 50dB
Contact Type	Crimp, fiber optic, coax, twinax, or printed circuit
Number of Circuits	2 to 128
Contact Insertion	Rear Insertion/Rear Extraction with simple plastic or high quality metal hand tools.
Polarization	Five keyways with optional master keyway rotations (Note insert and main keyways remain fixed)
Approvals	MIL-DTL-38999

Contact Retention

CONTACT SIZE	RETENTION AXIAL LOAD +/-10 PERCENT		SEPARATION FORCE MINIMUM (INITIAL)	
	NEWTONS	LBS.	NEWTONS	OUNCES
22D	44	10	0.19	0.7
20	15	67	0.19	0.7
16	25	111	0.56	2
12	25	111	0.83	3
8	25	111	1.39	5
8 Twinax	25	111	1.39	5

HOW TO ORDER DJT SERIES CONNECTORS - MILITARY

1	2	3A	4	3B	5	6	7
MS27468	T	25	F	35	P		-LC
SHELL STYLE	CLASS	SIZE	PLATING	LAYOUT	CONTACT	POLARIZATION	MODIFIER
(Military part number example)						(OMIT FOR NORMAL)	

STEP 1: SELECT SHELL STYLE, PLUG OR RECEPTACLE

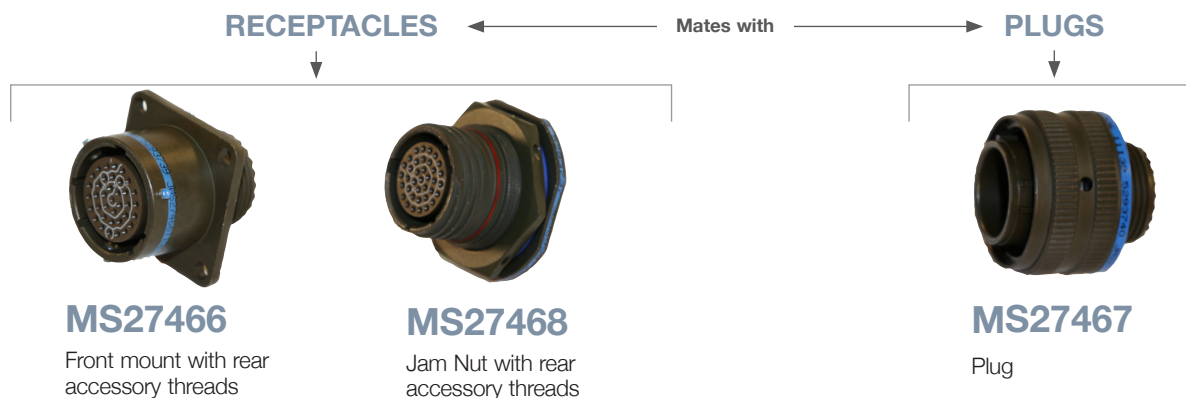

STEP 2: SELECT CLASS

T = No Rear Accessories
P = Potting Ring & Cup

Available with PC pins. Contact us for more details.

STEP 3: SELECT LAYOUT

⇨ See page 52 for listing by # of contacts

NUMBER	RATING	TOTAL	22D	20	16	12
9-35	M	6	6			
9-98	I	3		3		
11-5	I	5		5		
11-35	M	13	13			
11-99	I	7		7		
13-4	I	4			4	
13-35	M	22	22			
13-98	I	10		10		
15-5	II	5			5	
15-18	I	18		18		
15-35	M	37	37			
15-97	I	12		8	4	
17-6	I	6				6
17-8	II	8			8	
17-26	I	26		26		
17-35	M	55	55			
19-11	II	11			11	
19-32	I	32		32		
19-35	M	66	66			
21-11	I	11				11
21-16	II	16			16	
21-35	M	79	79			
21-41	I	41		41		
23-21	II	21			21	
23-35	M	100	100			
23-53	I	53		53		
23-55	I	55		55		
25-4	I	56		48	8	
25-19	I	19				19
25-24	I	24			12	12
25-29	I	29			29	
25-35	M	128	128			
25-61	I	61		61		

WHEN CHOOSING LAYOUT First Number = Step 3A – Shell Size, Second Number = 3B – Layout

STEP 4: SELECT PLATING



- B** = Olive Drab Chromate over Cadmium over Electroless Nickel -65°C to 175°C (-85°F to 347°F)
- F** = Electroless Nickel -65°C to 200°C (-85°F to 392°F)

STEP 5: SELECT CONTACT



- P** = Pin
- S** = Socket
- H** = 1500 cycle Pin contacts
- J** = 1500 cycle Socket contacts
- Note:** See Step 7 if you are not ordering contacts with part.

- A** = Less Pin Contacts
- B** = Less Socket Contact
- May be used for special contact types (PC Pin, Thermocouple, Fiber optic).

STEP 6: SELECT POLARIZATION



- Omit for normal
- A** = Next Most Popular
- B** = Limited Availability
- C** = Check for Availability
- D** = Check for Availability

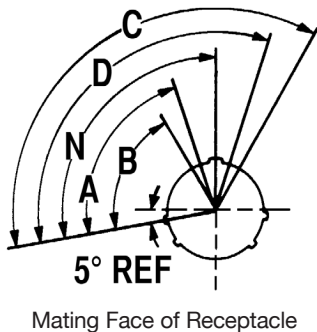

SHELL SIZE	N	A	B	C	D
9	95	77	-	-	113
11	95	81	67	123	109
13	95	75	63	127	115
15	95	74	61	129	116
17	95	77	65	125	113
19	95	77	65	125	113
21	95	77	65	125	113
23	95	80	69	121	110
25	95	80	69	121	110

STEP 7: SELECT MODIFIER



- Omit for standard contacts
- LC** = less contacts, wire hole fillers and plastic insertion/extraction tool. (Purchase Order must state Less Contacts)
- Note:** -LC is not marked on part

HOW TO ORDER DJT SERIES CONNECTORS - COMMERCIAL

1	2	3	4	5	6
DJT14	E	25-35	P	N	-LC
SHELL STYLE	PLATING	LAYOUT	CONTACT	POLARIZATION	MODIFIER

(Commercial part number example)

STEP 1: SELECT SHELL STYLE, PLUG OR RECEPTACLE



STEP 2: SELECT PLATING

- E** = Olive Drab Chromate over Cadmium over Electroless Nickel -65°C to 175°C (-85°F to 347°F)
- F** = Electroless Nickel -65°C to 200°C (-85°F to 392°F)

STEP 3: SELECT LAYOUT

⇒ See page 52 for listing by # of contacts

NUMBER	RATING	TOTAL	22D	20	16	12
9-35	M	6	6			
9-98	I	3		3		
11-5	I	5		5		
11-35	M	13	13			
11-99	I	7		7		
13-4	I	4			4	
13-35	M	22	22			
13-98	I	10		10		
15-5	II	5			5	
15-18	I	18		18		
15-35	M	37	37			
15-97	I	12		8	4	
17-6	I	6				6
17-8	II	8			8	
17-26	I	26		26		
17-35	M	55	55			
19-11	II	11			11	
19-32	I	32		32		
19-35	M	66	66			
21-11	I	11				11
21-16	II	16			16	
21-35	M	79	79			
21-41	I	41		41		
23-21	II	21			21	
23-35	M	100	100			
23-53	I	53		53		
23-55	I	55		55		
25-4	I	56		48	8	
25-19	I	19				19
25-24	I	24			12	12
25-29	I	29			29	
25-35	M	128	128			
25-61	I	61		61		

STEP 4: SELECT CONTACT



P = Pin
S = Socket
H = 1500 cycle Pin contacts
J = 1500 cycle Socket contacts
Note: See Step 7 if you are not ordering contacts with part.

A = Less Pin Contacts
B = Less Socket Contact
 May be used for special contact types (PC Pin, Thermocouple, Fiber optic).

STEP 5: SELECT POLARIZATION



N = Normal Standard
A = Next Most Popular
B = Limited Availability
C = Check for Availability
D = Check for Availability

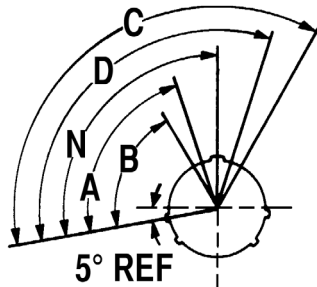

Mating Face of Receptacle

SHELL SIZE	N	A	B	C	D
9	95	77	-	-	113
11	95	81	67	123	109
13	95	75	63	127	115
15	95	74	61	129	116
17	95	77	65	125	113
19	95	77	65	125	113
21	95	77	65	125	113
23	95	80	69	121	110
25	95	80	69	121	110

STEP 6: SELECT MODIFIER



For other commercial modification, i.e., less tools, with PC contact or with endbell, contact us.

Omit for standard contacts

-LC = less contacts, wire hole fillers and plastic insertion/extraction tool. (Purchase Order must state Less Contacts)

Note: LC is not marked on part

LAYOUTS BY SHELL SIZE

•=22 ○=20 ◊=16 ▲=12 ⊕=8

LAYOUT	09-35	09-98	11-05	11-35	11-99	13-04	13-35
# OF CONTACTS	6 - #22	3 - #20	5 - #20	13 - #22	7 - #20	4 - #16	22 - #22
SERVICE RATING	M	I	I	M	I	I	M
LAYOUT	13-98	15-05	15-18	15-35	15-97*	17-06	17-08*
# OF CONTACTS	10 - #20	5 - #16	18 - #20	37 - #22	8 - #20, 4 - #16	6 - #12	8 - #16
SERVICE RATING	I	II	I	M	I	I	II
LAYOUT	17-26	17-35	19-11*	19-32	19-35	21-11*	21-16
# OF CONTACTS	26 - #20	55 - #22	11 - #16	32 - #20	66 - #22	11 - #12	16 - #16
SERVICE RATING	I	M	II	I	M	I	II
LAYOUT	21-41	21-35	23-21*	23-35*	23-53	23-55*	
# OF CONTACTS	41 - #20	79 - #22	21 - #16	100 - #22	53 - #20	55 - #20	
SERVICE RATING	I	M	II	M	I	I	
LAYOUT	25-04*	25-19*	25-24*	25-29*	25-35	25-61*	
# OF CONTACTS	48 - #20, 8 - #16	19 - #12	12 - #16, 12 - #12	29 - #16	128 - #22	61 - #20	
SERVICE RATING	I	I	I	I	M	I	

PINS

CONTACT SIZE	WIRE CRIMP SIZE RANGE	PIN PART NUMBER	COLOR BANDS			WIRE STRIP LENGTHS		WIRE INSULATION SEALING RANGE				WIRE HOLE FILLER	WIRE HOLE FILLER COLOR
			1	2	3	IN.	MM	MIN. IN.	MIN. MM	MAX. IN.	MAX. MM		
22D	28,26,24,22	M39029/58-360	Orange	Blue	Black	0.125	3.18	0.030	0.760	0.054	1.37	MS27488-22-2	Black
20	24,22,20	M39029/58-363	Orange	Blue	Orange	0.188	4.77	0.040	1.020	0.083	2.11	MS27488-20-2	Red
16	20,18,16	M39029/58-364	Orange	Blue	Yellow	0.188	4.77	0.065	1.65	0.109	2.77	MS27488-16-2	Blue
12	14,12	M39029/58-365	Orange	Blue	Green	0.188	4.77	0.097	2.46	0.142	3.61	MS27488-12-2	Yellow

SOCKETS

CONTACT SIZE	WIRE CRIMP SIZE RANGE	SOCKET PART NUMBER	COLOR BANDS			WIRE STRIP LENGTHS		WIRE INSULATION SEALING RANGE				WIRE HOLE FILLER	WIRE HOLE FILLER COLOR
			1	2	3	IN.	MM	MIN. IN.	MIN. MM	MAX. IN.	MAX. MM		
22D	28,26,24,22	M39029/56-348	Orange	Yellow	Gray	0.125	3.18	0.030	0.760	0.054	1.37	MS27488-22-2	Black
20	24,22,20	M39029/56-351	Orange	Green	Brown	0.188	4.77	0.040	1.020	0.083	2.11	MS27488-20-2	Red
16	20,18,16	M39029/56-352	Orange	Green	Red	0.188	4.77	0.065	1.65	0.109	2.77	MS27488-16-2	Blue
12	14,12	M39029/56-353	Orange	Green	Orange	0.188	4.77	0.097	2.46	0.142	3.61	MS27488-12-2	Yellow

CONTACT TOOLS

PINS

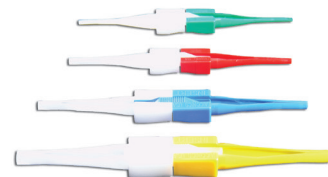

CONTACT SIZE	HAND CRIMP TOOL	TURRET HEAD (LOCATOR)	TURRET HEAD (LOCATOR) COLOR	POWER CRIMP TOOL	POWER TOOL LOCATOR	METAL		PLASTIC		
						INSERTION TOOL	EXTRACTION TOOL	INSERTION/ EXTRACTION TOOL	INSERTION TIP COLOR	EXTRACTION TIP COLOR
22D	M22520/2-01	M22520/2-09	-	WA22	M22520/2-09	MS27495A22M	MS27495A22M	M81969/14-01	Green	White
20	M22520/1-01	M22520/1-04	Red	WA27F	M22520/1-04	MS27495A20	MS27495A20	M81969/14-10	Red	Orange
16	M22520/1-01	M22520/1-04	Blue	WA27F	M22520/1-04	MS27495A16	MS27495A16	M81969/14-03	Blue	White
12	M22520/1-01	M22520/1-04	Yellow	WA27F	M22520/1-04	DAK95-12B	DRK95-12B	M81969/14-04	Yellow	White

SOCKETS

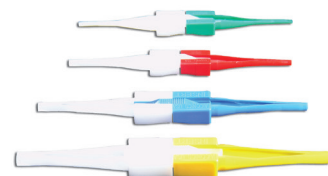

CONTACT SIZE	HAND CRIMP TOOL	TURRET HEAD (LOCATOR)	TURRET HEAD (LOCATOR) COLOR	POWER CRIMP TOOL	POWER TOOL LOCATOR	METAL		PLASTIC		
						INSERTION TOOL	EXTRACTION TOOL	INSERTION/ EXTRACTION TOOL	INSERTION TIP COLOR	EXTRACTION TIP COLOR
22D	M22520/2-01	M22520/2-09	-	WA22	M22520/2-09	MS27495A22M	MS27495A22M	M81969/14-01	Green	White
20	M22520/1-01	M22520/1-04	Red	WA27F	M22520/1-04	MS27495A20	MS27495A20	M81969/14-10	Red	Orange
16	M22520/1-01	M22520/1-04	Blue	WA27F	M22520/1-04	MS27495A16	MS27495A16	M81969/14-03	Blue	White
12	M22520/1-01	M22520/1-04	Yellow	WA27F	M22520/1-04	DAK95-12B	DRK95-12B	M81969/14-04	Yellow	White

PLUGS

MS27467/ DJT16

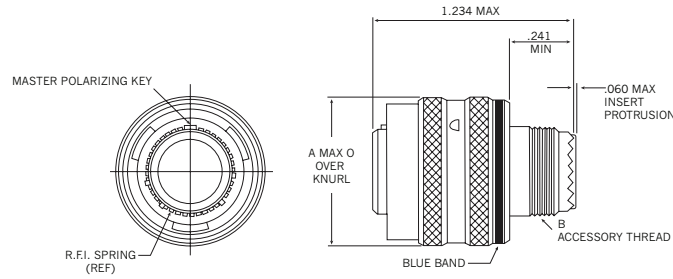

SHELL SIZE	A DIA. +/- .020 (+/- 0.51)	B THREAD UNEF-2A
9	0.859 (21.81)	0.4375-28
11	0.984 (24.99)	0.5625-24
13	1.156 (29.36)	0.6875-24
15	1.281 (32.53)	0.8125-20
17	1.406 (35.71)	0.9375-20
19	1.516 (38.50)	1.0625-18
21	1.641 (41.68)	1.1875-18
23	1.766 (44.85)	1.3125-18
25	1.891 (48.03)	1.4375-18

FLANGE MOUNT

MS27466/ DJT10

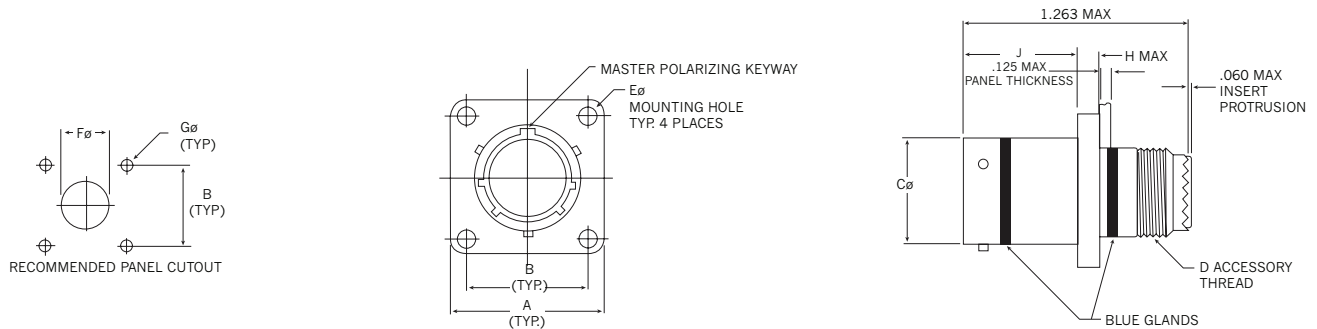

SHELL SIZE	A +/- .020 (+/- .508)	B +/- .005 (+/- .127)	C DIA. +/- .003 (+/- .076)	D THREAD UNEF-2A	E DIA. +.010/- .005 (+ .254/ -.127)	F DIA. MIN.	G DIA. +/- .005 (+/- .127)	H MAX.	J +.000/ -.005 (+ 0 / -.127)
9	0.938 (23.82)	0.719 (18.26)	0.570 (14.47)	0.4375-28	0.128 (3.25)	0.516 (13.10)	0.128 (3.25)	.100 (2.54)	0.632 (16.05)
11	1.031 (26.18)	0.812 (20.62)	0.698 (17.72)	0.5625-24	0.128 (3.25)	0.664 (16.86)	0.128 (3.25)	.100 (2.54)	0.632 (16.05)
13	1.125 (28.57)	0.906 (23.01)	0.848 (21.53)	0.6875-24	0.128 (3.25)	0.750 (19.05)	0.128 (3.25)	.100 (2.54)	0.632 (16.05)
15	1.219 (30.96)	0.969 (24.61)	0.973 (24.71)	0.8125-20	0.128 (3.25)	0.906 (23.01)	0.128 (3.25)	.100 (2.54)	0.632 (16.05)
17	1.312 (33.32)	1.062 (26.97)	1.098 (27.88)	0.9375-20	0.128 (3.25)	1.016 (25.80)	0.128 (3.25)	.100 (2.54)	0.632 (16.05)
19	1.438 (36.52)	1.156 (29.36)	1.205 (30.60)	1.0625-18	0.128 (3.25)	1.141 (28.98)	0.128 (3.25)	.100 (2.54)	0.632 (16.05)
21	1.562 (39.67)	1.250 (31.75)	1.330 (33.78)	1.1875-18	0.128 (3.25)	1.266 (32.15)	0.128 (3.25)	.130 (3.30)	0.602 (15.29)
23	1.688 (42.87)	1.375 (34.92)	1.455 (36.95)	1.3125-18	0.147 (3.73)	1.377 (34.97)	1.54 (39.11)	.130 (3.30)	0.602 (15.29)
25	1.812 (46.02)	1.500 (38.10)	1.580 (40.13)	1.4375-18	0.147 (3.73)	1.484 (37.69)	1.54 (39.11)	.130 (3.30)	0.602 (15.29)

All dimensions in inches (millimeters in parenthesis)

JAM NUT RECEPTACLE



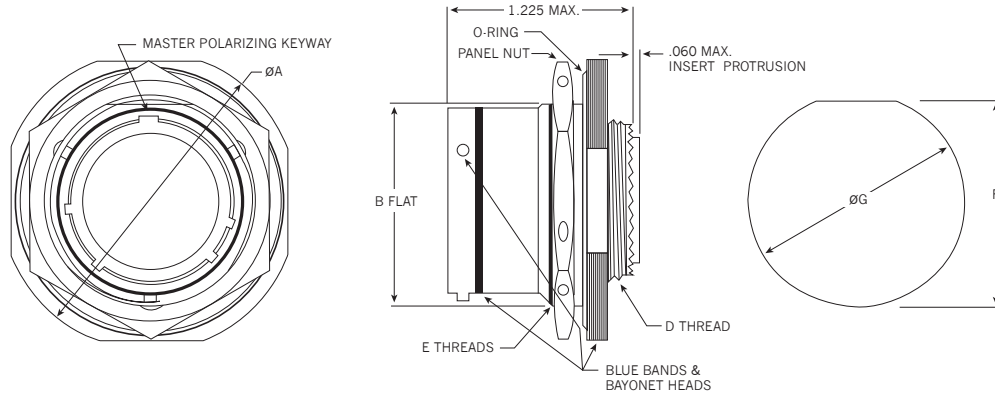

MS27484/ DJT14



SHELL SIZE	A DIA. $\pm .016$ ($\pm .406$)	B FLAT $\pm .000/- .010$ ($\pm .000/- .254$)	D THREAD UNEF -2A	E THREAD UNEF -2A	F $\pm .000/- .010$ ($\pm .000/- .254$)	G DIA. $\pm .000/- .010$ ($\pm .000/- .254$)
9	1.188 (30.18)	0.655 (16.64)	0.4375-28	0.6875-24	0.670 (17.02)	0.700 (17.78)
11	1.375 (34.93)	0.755 (19.18)	0.5625-24	0.8125-20	0.771 (19.58)	0.825 (20.96)
13	1.500 (38.10)	0.942 (23.93)	0.6875-24	1.000-20	0.955 (24.26)	1.010 (25.65)
15	1.625 (41.28)	1.066 (27.08)	0.8125-20	1.1250-18	1.085 (27.60)	1.135 (28.83)
17	1.750 (44.45)	1.191 (30.25)	0.9375-20	1.2500-18	1.210 (30.73)	1.260 (32.00)
19	1.938 (49.23)	1.316 (33.43)	1.0625-18	1.3750-18	1.335 (33.91)	1.385 (35.18)
21	2.062 (52.37)	1.441 (36.60)	1.1875-18	1.5000-18	1.460 (37.08)	1.510 (38.35)
23	2.188 (55.58)	1.566 (39.78)	1.3125-18	1.6250-18	1.585 (40.26)	1.635 (41.53)
25	2.312 (58.72)	1.691 (42.95)	1.4375-18	1.7500-18	1.710 (43.43)	1.760 (44.70)

All dimensions in inches (millimeters in parenthesis)

DUMMY RECEPTACLES, DUST CAPS & PLUG CAPS

				
DJT	DUMMY RECEPTACLES	RECEPTACLE DUST CAPS		PLUG DUST CAP
		FOR FLANGED	FOR JAM NUT	
9	M38999/9-9B	MS27502**9C	MS27502**9N	MS27501**9C
11	M38999/9-11B	MS27502**11C	MS27502**11N	MS27501**11C
13	M38999/9-13B	MS27502**13C	MS27502**13N	MS27501**13C
15	M38999/9-15B	MS27502**15C	MS27502**15N	MS27501**15C
17	M38999/9-17B	MS27502**17C	MS27502**17N	MS27501**17C
19	M38999/9-19B	MS27502**19C	MS27502**19N	MS27501**19C
21	M38999/9-21B	MS27502**21C	MS27502**21N	MS27501**21C
23	M38999/9-23B	MS27502**23C	MS27502**23N	MS27501**23C
25	M38999/9-25B	MS27502**25C	MS27502**25N	MS27501**25C

** Select Code for Plating

B = Olive Drab Chromate over Cadmium over Nickel

F = Electroless Nickel

A = Gold Iridite over Cadmium Nickel

C = Hard Anodized

CABLE CLAMPS

						
DJT	STRAIGHT LOW COST	RIGHT ANGLE LOW COST	CABLE RANGE			
			MIN		MAX	
			INCHES	MM	INCHES	MM
9	M85049/49-2-8**	M85049/47**8	0.098	2.49	0.234	5.94
11	M85049/49-2-10**	M85049/47**10	0.153	3.89	0.234	5.94
13	M85049/49-2-12**	M85049/47**12	0.190	4.83	0.328	8.33
15	M85049/49-2-14**	M85049/47**14	0.260	6.60	0.457	11.61
17	M85049/49-2-16**	M85049/47**16	0.283	7.19	0.614	15.60
19	M85049/49-2-18**	M85049/47**18	0.325	8.25	0.634	16.10
21	M85049/49-2-20**	M85049/47**20	0.343	8.71	0.698	17.73
23	M85049/49-2-22**	M85049/47**22	0.381	9.68	0.823	20.90
25	M85049/49-2-24**	M85049/47**24	0.418	10.62	0.853	21.67

** Select Code for Plating







W = Olive Drab Chromate over Cadmium over Nickel

N = Electroless Nickel

A = Hard Anodized

All dimensions in inches (millimeters in parenthesis)

STANDARD MIL-SPEC

MIL-SPEC PREFIX	SEALED	EMI/RFI	S = STRAIGHT A = 90 DEGREES B = 45 DEGREES	ENDBELL TYPE	DESCRIPTION
M85049/62 	Y	N	S	Heat Shrink Boot Adapters	Designed for use with straight or right angle shrink boots. A knurled rear section with a boot groove provide an excellent surface for the boot to grab the metal endbell. Available with lock wire and drain holes. → See Heat Shrink Boots on pages 168-169.
M85049/32 	N	N	S	Extender Backshell with cable clamp	Non-environmental, designed for use with jacketed cable, allows extra space to break out the wires and still provide strain relief clamping to the outside of the cable jacket.
M85049/17 	Y	Y	S	Environmental Shielded Endbell	This EMI/RFI shielding environmentally sealing endbell features a standard style cable clamp with gland seal at the end of and extender style backshell.
M85049/29 	N	Y	S	Non-Environmental Shielded Endbell	This EMI/RFI shielding non-environmentally sealing endbell features a standard style cable clamp.
M85049/85 M85049/86 M85049/87 	Y	Y	S B A	Banding Adapter	Banding adapters utilize a band of metal that fastens and grounds cable shields to the outside of endbells. This method of terminating shields has advantages in that they typically use tools to tighten trim the bands. These tools make the termination tight, repeatable, reworkable (if you make a mistake just cut the band off and start again) and facilitates service. Banding adapters help lower the total applied cost by having simpler designs that have fewer parts with uncomplicated assembly procedures.
M85049/27 	N	N	S	Compression Nut	Wire Seal Compression Nut

NOTE: If military-standard versions won't work for your applications, please contact us with your requirements.

WIRE STRIPPING

Strip insulation from end of wire to be crimped. (See table for proper stripping dimensions.) Do not cut or damage wire strands.

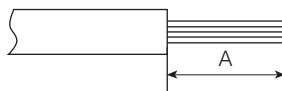

WIRE SIZE	A
22, 22M, 22D	.125 (3.18)
20	.188 (4.77)
16	.188 (4.77)
12	.188 (4.77)
10	.335 (8.51)
8 (power)	.470 (11.99)

CONTACT CRIMPING

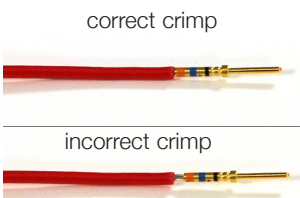

STEP 1: Strip wires. See above for correct strip length for contact. Insert wire into rear of contact. Wire insulation must push against rear of contact. Wire must be visible through inspection hole.

STEP 2: M22520 series crimp tool and locator is recommended. → See page 54 for choice of turret head and selection setting according to correct size, part number and wire gauge size.

STEP 3: Insert contact and wire into tool jaws. To crimp, squeeze handles together fully until ratchet releases and allows handles to expand; otherwise, contact cannot be extracted from tool jaws. Maintain slight insertion pressure on wire while crimping contact to wire.*

CONTACT INSERTION

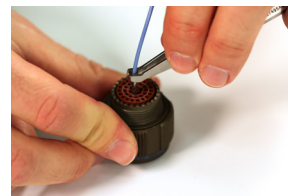
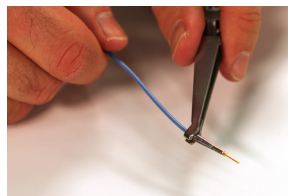
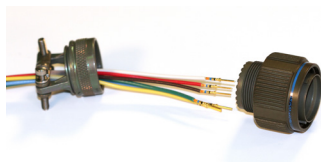

STEP 1: Remove hardware from plug or receptacle and slip over wire bundle in proper order for reassembly.

STEP 2: Using proper plastic or metal insertion tool for corresponding contact, position wire in tip of the tool so that the tool tip presses against the contact shoulder.

STEP 3: Press tool against contact shoulder and, with firm and even pressure, insert wired contact and tool tip into center contact cavity.

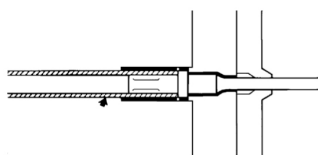

STEP 4: When contact bottoms, a slight "click" can be heard as tines of metal retaining clip snap into place behind contact shoulder.

STEP 5: Remove tool and pull back lightly on wire to make sure contact is properly seated. Repeat operation with remainder of contacts to be inserted, beginning with the center cavity and working outward in alternating rows.

STEP 6: After all contacts are inserted, fill any empty cavities with wire sealing plugs. Reassemble plug or receptacle hardware.

ASSEMBLY INSTRUCTIONS

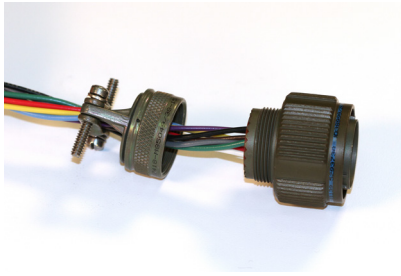

STEP 1: Remove hardware from plug or receptacle and slide hardware back along wire bundle.

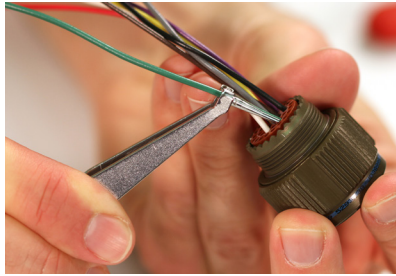

STEP 2: Using plastic or metal extraction tool with proper color code corresponding to contact size, place wire in tool.

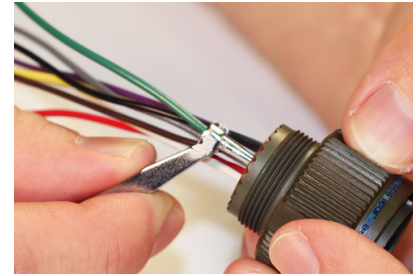

STEP 3: Insert tool into contact cavity until tool tip bottoms against the contact shoulder, expanding clip retaining tines.

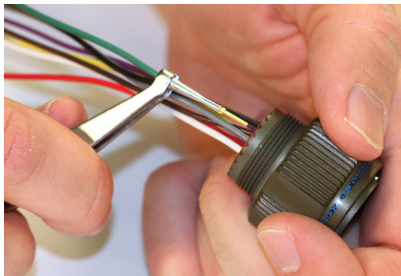

STEP 4: Hold wire firmly in tool and extract wired contact and tool. Repeat operation for all contacts to be extracted.

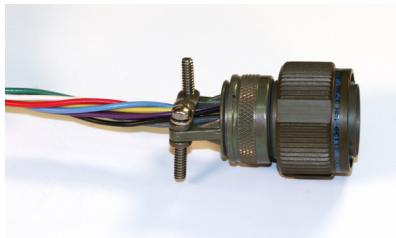

STEP 5: Fill any empty cavities with wire sealing plugs. Reassemble plug or receptacle hardware.

Note: DTS series shown.

TE Connectivity DEUTSCH DTS Series MIL-DTL-38999 Series III Metal Connectors



INTERMATEABLE WITH SOURIAU CONNECTORS AND ALL MIL-DTL-38999 SERIES III

TE DEUTSCH DTS series MIL-DTL-38999 series III metal connectors offer high density contact arrangements in a miniature metal circular connector. DTS connectors meet MIL-38999 and were originally designed as military and aerospace components. The TE DEUTSCH DTS series is now being used in many applications requiring extremely reliable interconnections. These TE DEUTSCH connectors are quick-mating, environmentally-sealed, triple-lead threaded, have a self-locking coupling, and are EMI-RFI-shielded. A variety of D38999 backshells are available. For full product details on the TE DEUTSCH DTS series MIL-DTL-38999 series III metal connectors, please see the specifications below.

APPLICATIONS

- High-performance military aircraft
- Commercial aircraft
- Communications equipment
- Armored personnel carriers & tanks
- High temperature industrial equipment
- Missiles
- Shipboard

FEATURES

- High reliability
- Outstanding EMI/RFI shielding protection
- High density
- Self-locking connector systems
- MIL-DTL-38999
- Scoop-proof contact protection

MATERIALS AND FINISHES

Shell	Aluminium alloy or stainless steel
Shell Plating	Electroless Nickel, Olive Drab Chromate over nickel, Black Zinc Nickel, Nickel PTFE
Contacts	Copper alloy
Contact Platings	50u" gold plated
Insulator	Rigid plastic dielectric
Seals	Fluorinated silicone based elastomer

ELECTRICAL DATA

Wire Range Sizes	12-24AWG
Insulation Resistance	5000 Megaohms minimum at 77°F (25°C)

Contact Resistance of mated contacts end to end

CONTACT SIZE	MAXIMUM MILLIVOLT DROP
22D	40
20	35
16	25
12	25

Test Voltage ac rms

SERVICE RATING	SEA LEVEL		100,000 FEET ALTITUDE	
	MATED	UNMATED	MATED	UNMATED
M	1300	1300	800	200
N	1000	1000	600	200
I	1800	1800	1000	200
II	2300	2300	1000	200

Current Rating

WIRE SIZE	CONTACT SIZE	MAX. CURRENT FOR TEST IN AMPS	POTENTIAL DROP MILLIVOLT AT 77°F (25°C)
24	20	3	<45
20	20	7.5	<55
20	16	7.5	<45
16	16	13	<50
14	12	17	<45
12	12	23	<50

MECHANICAL DATA

Operating Temperature	Z - Black Zinc Nickel -65°C to +175°C (-85°F to +347°F)
	W - Olive drab -65°C to +175°C (-85°F to +347°F)
	F - Electroless nickel -65°C to +200°C (-85°F to +392°F)
	K - Stainless steel -65°C to +200°C (-85°F to +392°F)
	S - Electrodeposited nickel stainless steel -65°C to +200°C (-85°F to +392°F)
Sealing	Against sand, dust per MIL-STD-202 & ice resistance

MECHANICAL DATA

Wire Sealing Range

CONTACT SIZE	MINIMUM		MAXIMUM	
	INCHES	MM	INCHES	MM
22D	0.030	0.76	0.054	1.37
20	0.040	1.02	0.830	2.11
16	0.065	1.65	0.109	2.77
12	0.097	2.46	0.142	3.61
8 (Coax)	0.135	3.43	0.155	3.94
8 (Twinax)	0.124	3.15	0.134	3.40

Insulation Strip Length

CONTACT SIZE	STRIP LENGTH	
	INCHES	MM
22D	0.125	3.18
20	0.188	4.77
16	0.188	4.77
12	0.188	4.77

Mating Life	500 mating cycle
Salt Spray	Z - Black Zinc Nickel, 500 hours per MIL-STD-1344A method 1001 condition C W - Olive Drab, 500 hours per MIL-STD-1344A method 1001 condition C F - Electroless Nickel, 48 hours per MIL-STD-1344A method 1001 condition B K - Stainless Steel, 2000 hours per MIL-STD-1344A method 1001 condition C S - Electrodeposited Nickel Stainless Steel, 2000 hours per MIL-STD-1344A method 1001 condition C
Temp Durability	Z - Black Zinc Nickel -65°C to +175°C (-85°F to +347°F) W - Olive drab -65°C to +175°C (-85°F to +347°F) F - Electroless nickel -65°C to +200°C (-85°F to +392°F) K - Stainless steel -65°C to +200°C (-85°F to +392°F) S - Electrodeposited nickel stainless steel -65°C to +200°C (-85°F to +392°F)
Chemical Resistance	Lubricating oils, hydraulic fluids, coolants, deicing fluids per MIL-STD-1344A Method 1016 condition a-1
Sine Vibration	60g at -55°C per MIL-DTL-38999L 4.5.23.2.1
Random Vibration	49.5 grms at ambient temperatures
Shock	300 grms
EMI Shielding Effectiveness	100 MHz to 10 GHz - minimum attenuation of 50dB
Contact Type	Crimp, fiber optic, coax, twinax, or printed circuit
Number of Circuits	2 to 128
Contact Insertion	Rear Insertion/Rear Extraction with simple plastic or high quality metal hand tools
Polarization	Five keyways with optional master keyway rotations (Note insert and main keyways remain fixed)
Approvals	MIL-DTL-38999

Contact Retention

CONTACT SIZE	RETENTION AXIAL LOAD +/-10 PERCENT		SEPARATION FORCE MINIMUM (INITIAL)	
	NEWTONS	LBS.	NEWTONS	OUNCES
22D	44	10	0.19	0.7
20	15	67	0.19	0.7
16	25	111	0.56	2.0
12	25	111	0.83	3.0
8	25	111	1.39	5.0
8 Twinax	25	111	1.39	5.0

HOW TO ORDER DTS/D38999 SERIES CONNECTORS

1	2	3	4	5	6
D38999/20	F	A35	P	A	-L/C
SHELL STYLE	FINISH	LAYOUT	CONTACT	POLARIZATION	MODIFIER

(Military part number example)

1	2	3	4	5	6
DTS20	F	9-35	P	A	-LC
SHELL STYLE	FINISH	LAYOUT	CONTACT	POLARIZATION (OMIT FOR NORMAL)	MODIFIER

(Commercial part number example)

STEP 1: SELECT SHELL STYLE, PLUG OR RECEPTACLE



STEP 2: SELECT FINISH

- | | |
|--|--|
| <ul style="list-style-type: none"> F = Electroless Nickel K = Stainless Steel -45dB G = Space Grade, Outgassed | <ul style="list-style-type: none"> W = Olive Drab Chromate over Cadmium over Electroless Nickel S = Stainless Steel / Electroless Nickel -65dB Z = Black Zinc Nickel |
|--|--|

Available with PC pins. Contact us for more details.

STEP 3: SELECT LAYOUT

⇒ See page 66 for listing by # of contacts

MILITARY D38999 LAYOUT	COMMERCIAL DTS LAYOUT	SERVICE RATING	CONTACTS					
			TOTAL NUMBER	22D	20	16	12	8
A35	9-35	M	6	6				
A98	9-98	I	3		3			
-	11-01		1					1
B5	11-5	I	5		5			
-	11-12		1				1	
B35	11-35	M	13	13				
B98	11-98	I	6		6			
B99	11-99	I	7		7			
C4	13-4	I	4			4		
C8	13-8	I	8		8			
C35	13-35	M	22	22				
C98	13-98	I	10		10			
D5	15-5	II	5			5		
D15	15-15	I	15		14	1		
D18	15-18	I	18		18			
D19	15-19	I	19		19			
D35	15-35	M	37	37				
D97	15-97	I	12		8	4		
E6	17-6	I	6				6	
E8	17-8	II	8			8		
E26	17-26	I	26		26			
E35	17-35	M	55	55				
-	17-75	I	2					2
E99	17-99	I	23		21	2		
F11	19-11	II	11			11		
F32	19-32	I	32		32			
F35	19-35	M	66	66				
G11	21-11	I	11				11	
G16	21-16	II	16			16		
G35	21-35	M	79	79				
G39	21-39	I	39		37	2		
G41	21-41	I	41		41			
G75	21-75	N	4					4*
H21	23-21	II	21			21		
H35	23-35	M	100	100				
H53	23-53	I	53		53			
H55	23-55	I	55		55			
J4	25-4	I	56		48	8		
J19	25-19	I	19				19	
J20	25-20	N	30		10	13	4*	3**
J24	25-24	I	24			12	12	
J29	25-29	I	29			29		
J35	25-35	M	128	128				
-	25-36		39		24	10	2	3
-	25-41		46		40	4		2
J46	25-46	I	46		40	4		2*
J61	25-61	I	61		61			

* Coax **Twinax

STEP 4: SELECT CONTACT

- P** = Pin
S = Socket
H = 1500 cycle Pin contacts (military only)
J = 1500 cycle Socket contacts (military only)
Note: See Step 6 if you are not ordering contacts with part.
A = Less Pin Contacts
B = Less Socket Contacts
 May be used for special contact types (PC Pin, Thermocouple, Fibre Optic).
U = PCB Pin contacts (commercial only)
M = PCB socket contacts (commercial only)

STEP 5: SELECT POLARIZATION

- N** = Normal (Standard)
A = Next Most Popular
B = Not Popular (limited availability)
C = Check for availability
D = Check for availability
E = Check for availability

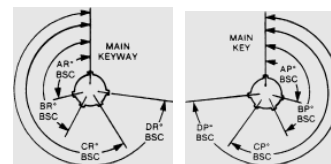

Receptacle Plug

SHELL SIZE	POLARIZATION	MINOR KEY LOCATIONS			
		AR & AP	BR & BP	CR & CP	DR & DP
9	N	105	140	215	265
	A	102	132	248	320
	B	80	118	230	312
	C	35	140	205	275
	D	64	155	234	304
E	91	131	197	240	
11	N	95	141	208	236
13	A	113	156	182	292
15	B	90	145	195	252
	C	53	156	220	255
	D	119	146	176	298
	E	51	141	184	242
17	N	80	142	196	293
19	A	135	170	200	310
	B	49	169	200	244
	C	66	140	200	257
	D	62	145	180	280
	E	79	153	197	272
21	N	80	142	196	293
23	A	135	170	200	310
25	B	49	169	200	244
	C	66	140	200	257
	D	62	145	180	280
	E	79	153	197	272

STEP 6: SELECT MODIFIER

For other commercial modification, i.e., less tools, with pc contact or with endbell, call.

- Omit for standard contacts
-LC = for use with standard contacts, but supplied without contacts, seal plugs or tools (PO must state Less Contacts)
Note: -LC is not marked on part

LAYOUTS BY SHELL SIZE

•=22 ○=20 ◊=16 ▲=12 ⊕=8

LAYOUT	09-35	09-98	11-01*	11-05	11-12*	11-35	11-98
# OF CONTACTS	6 - #22	3 - #20	1 - #8	5 - #20	1 - #12	13 - #22	6 - #20
SERVICE RATING	M	I		I		M	I
LAYOUT	11-99	13-04	13-08	13-35	13-98	15-05	15-15*
# OF CONTACTS	7 - #20	4 - #16	8 - #20	22 - #22	10 - #20	5 - #16	14 - #20, 1 - #16
SERVICE RATING	I	I	I	M	I	II	I
LAYOUT	15-18	15-19	15-35	15-97*	17-06	17-08*	17-26
# OF CONTACTS	18 - #20	19 - #20	37 - #22	8 - #20, 4 - #16	6 - #12	8 - #16	26 - #20
SERVICE RATING	I	I	M	I	I	II	I
LAYOUT	17-35	17-75*	17-99*	19-11*	19-32	19-35	21-11*
# OF CONTACTS	55 - #22	2 - #8	21 - #20, 2 - #16	11 - #16	32 - #20	66 - #22	11 - #12
SERVICE RATING	M	I	I	II	I	M	I
LAYOUT	21-16	21-35	21-39	21-41	21-75*	23-21*	
# OF CONTACTS	16 - #16	79 - #22	2 - #16, 37 - #20	41 - #20	4 - #8	21 - #16	
SERVICE RATING	II	M	I	I	N	II	
LAYOUT	23-35*	23-53	23-55*	25-04*	25-19*	25-20*	
# OF CONTACTS	100 - #22	53 - #20	55 - #20	48 - #20, 8 - #16	19 - #12	10 - #20, 13 - #16, 4 - #12, 3 - #8	
SERVICE RATING	M	I	I	I	I	N	

PINS

CONTACT SIZE	WIRE CRIMP SIZE RANGE	PIN PART NUMBER	COLOR BANDS			WIRE STRIP LENGTHS		WIRE INSULATION SEALING RANGE				WIRE HOLE FILLER	WIRE HOLE FILLER COLOR
			1	2	3	IN.	MM	MIN. IN.	MIN. MM	MAX. IN.	MAX. MM		
22D	28,26,24,22	M39029/58-360	Orange	Blue	Black	0.125	3.18	0.030	0.760	0.054	1.37	MS27488-22-2	Black
20	24,22,20	M39029/58-363	Orange	Blue	Orange	0.188	4.77	0.040	1.020	0.083	2.11	MS27488-20-2	Red
16	20,18,16	M39029/58-364	Orange	Blue	Yellow	0.188	4.77	0.065	1.65	0.109	2.77	MS27488-16-2	Blue
12	14,12	M39029/58-365	Orange	Blue	Green	0.188	4.77	0.097	2.46	0.142	3.61	MS27488-12-2	Yellow

SOCKETS

CONTACT SIZE	WIRE CRIMP SIZE RANGE	SOCKET PART NUMBER	COLOR BANDS			WIRE STRIP LENGTHS		WIRE INSULATION SEALING RANGE				WIRE HOLE FILLER	WIRE HOLE FILLER COLOR
			1	2	3	IN.	MM	MIN. IN.	MIN. MM	MAX. IN.	MAX. MM		
22D	28,26,24,22	M39029/56-348	Orange	Yellow	Gray	0.125	3.18	0.030	0.760	0.054	1.37	MS27488-22-2	Black
20	24,22,20	M39029/56-351	Orange	Green	Brown	0.188	4.77	0.040	1.020	0.083	2.11	MS27488-20-2	Red
16	20,18,16	M39029/56-352	Orange	Green	Red	0.188	4.77	0.065	1.65	0.109	2.77	MS27488-16-2	Blue
12	14,12	M39029/56-353	Orange	Green	Orange	0.188	4.77	0.097	2.46	0.142	3.61	MS27488-12-2	Yellow

PINS

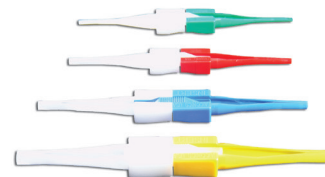

CONTACT SIZE	HAND CRIMP TOOL	TURRET HEAD (LOCATOR)	TURRET HEAD (LOCATOR) COLOR	POWER CRIMP TOOL	POWER TOOL LOCATOR	METAL		PLASTIC		
						INSERTION TOOL	EXTRACTION TOOL	INSERTION/ EXTRACTION TOOL	INSERTION TIP COLOR	EXTRACTION TIP COLOR
22D	M22520/2-01	M22520/2-09	-	WA22	M22520/2-09	MS27495A22M	MS27495A22M	M81969/14-01	Green	White
20	M22520/1-01	M22520/1-04	Red	WA27F	M22520/1-04	MS27495A20	MS27495A20	M81969/14-10	Red	Orange
16	M22520/1-01	M22520/1-04	Blue	WA27F	M22520/1-04	MS27495A16	MS27495A16	M81969/14-03	Blue	White
12	M22520/1-01	M22520/1-04	Yellow	WA27F	M22520/1-04	DAK95-12B	DRK95-12B	M81969/14-04	Yellow	White

SOCKETS

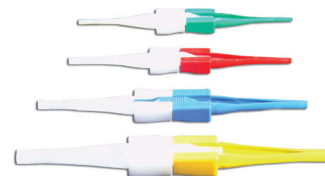

CONTACT SIZE	HAND CRIMP TOOL	TURRET HEAD (LOCATOR)	TURRET HEAD (LOCATOR) COLOR	POWER CRIMP TOOL	POWER TOOL LOCATOR	METAL		PLASTIC		
						INSERTION TOOL	EXTRACTION TOOL	INSERTION/ EXTRACTION TOOL	INSERTION TIP COLOR	EXTRACTION TIP COLOR
22D	M22520/2-01	M22520/2-09	-	WA22	M22520/2-09	MS27495A22M	MS27495A22M	M81969/14-01	Green	White
20	M22520/1-01	M22520/1-04	Red	WA27F	M22520/1-04	MS27495A20	MS27495A20	M81969/14-10	Red	Orange
16	M22520/1-01	M22520/1-04	Blue	WA27F	M22520/1-04	MS27495A16	MS27495A16	M81969/14-03	Blue	White
12	M22520/1-01	M22520/1-04	Yellow	WA27F	M22520/1-04	DAK95-12B	DRK95-12B	M81969/14-04	Yellow	White

TYPE 26 PLUG

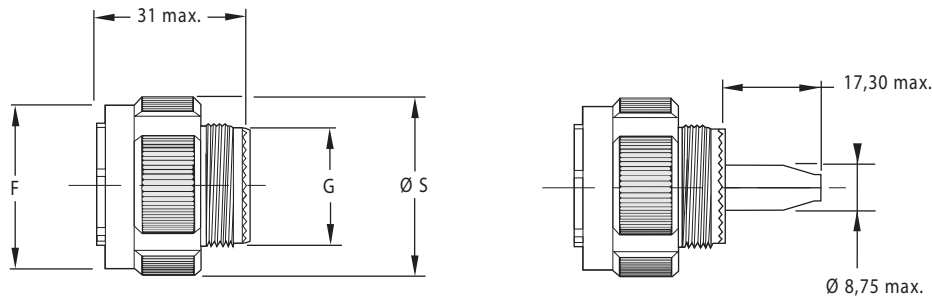

SHELL SIZE	F +.008/-0 (+0.2/-0)	G +/- .004 (+/-0.1)	S MAX.	REAR METRIC THREAD (PLATED)	MASS MAX.*
A/9	.720 (18.4)	.470 (11.9)	.860 (21.8)	M12x1.0-6g 0.100R	15.00 g
B/11	.830 (21.1)	.590 (14.9)	.980 (25.0)	M15x1.0-6g 0.100R	20.00 g
C/13	1.00 (25.4)	.700 (17.9)	1.16 (29.4)	M18x1.0-6g 0.100R	31.00 g
D/15	1.13 (28.7)	.860 (21.9)	1.28 (32.5)	M22x1.0-6g 0.100R	42.00 g
E/17	1.27 (32.2)	.980 (24.9)	1.41 (35.7)	M25x1.0-6g 0.100R	55.00 g
F/19	1.37 (34.9)	1.10 (27.9)	1.52 (38.5)	M28x1.0-6g 0.100R	63.00 g
G/21	1.50 (38.1)	1.22 (30.9)	1.64 (41.7)	M31x1.0-6g 0.100R	79.00 g
H/23	1.62 (41.1)	1.33 (33.9)	1.77 (44.9)	M34x1.0-6g 0.100R	88.00 g
J/25	1.74 (44.3)	1.45 (36.9)	1.89 (48.0)	M37x1.0-6g 0.100R	109.00 g

TYPE 20 SQUARE FLANGE

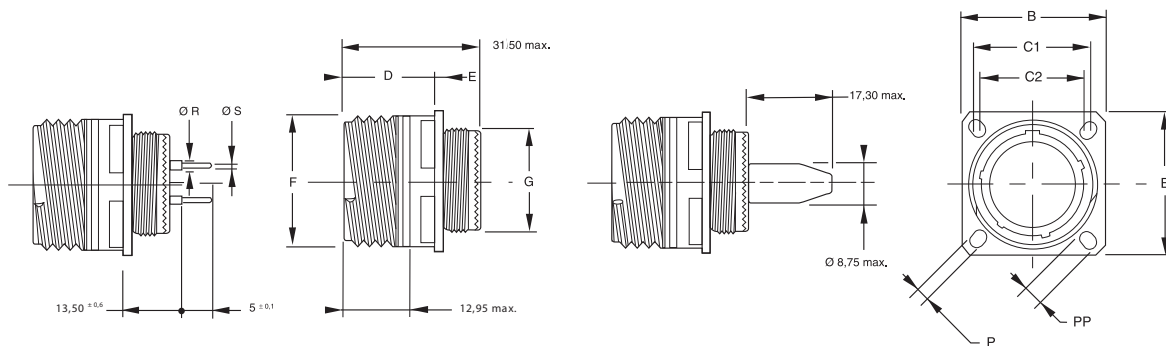

SHELL SIZE	B +/--.012 (+/-0.3)	C1	C2	D MAX.	E +.000 / -.016 (+0 / -0.4)	F +/--.004 (+/-0.1)	G +/--.004 (+/-0.1)	P +/--.008 (+/-0.2)	PP +/--.008 (+/-0.2)	REAR METRIC THREAD (PLATED)	MASS MAX.*
A/9	0.94 (23.80)	0.72 (18.26)	0.59 (15.09)	0.82 (20.90)	.008/.100 (2.10/2.50)	.620 (15.75)	.470 (11.90)	.130 (3.25)	.220 (5.49)	M12x1.0-6g 0.100R	10.00 g
B/11	1.03 (26.20)	0.81 (20.62)	0.72 (18.26)	0.82 (20.90)	.008/.100 (2.10/2.50)	.740 (18.90)	.590 (14.90)	.130 (3.25)	.190 (4.93)	M15x1.0-6g 0.100R	16.00 g
C/13	1.13 (28.60)	0.91 (23.01)	0.81 (20.62)	0.82 (20.90)	.008/.100 (2.10/2.50)	.870 (22.10)	.700 (17.90)	.130 (3.25)	.190 (4.93)	M18x1.0-6g 0.100R	22.00 g
D/15	1.22 (31.00)	0.97 (24.61)	0.91 (23.01)	0.82 (20.90)	.008/.100 (2.10/2.50)	.990 (25.25)	.860 (21.90)	.130 (3.25)	.190 (4.93)	M22x1.0-6g 0.100R	31.00 g
E/17	1.31 (33.30)	1.06 (26.97)	0.97 (24.61)	0.82 (20.90)	.008/.100 (2.10/2.50)	1.18 (29.95)	.980 (24.90)	.130 (3.25)	.190 (4.93)	M25x1.0-6g 0.100R	46.00 g
F/19	1.44 (36.50)	1.16 (29.36)	1.06 (26.97)	0.82 (20.90)	.008/.100 (2.10/2.50)	1.24 (31.55)	1.10 (27.90)	.130 (3.25)	.190 (4.93)	M28x1.0-6g 0.100R	51.00 g
G/21	1.56 (39.70)	1.25 (31.75)	1.16 (29.36)	0.79 (20.10)	.008/.130 (2.10/3.20)	1.37 (34.70)	1.22 (30.90)	.130 (3.25)	.190 (4.93)	M31x1.0-6g 0.100R	65.00 g
H/23	1.69 (42.90)	1.38 (34.93)	1.25 (31.75)	0.79 (20.10)	.008/.130 (2.10/3.20)	1.49 (37.90)	1.33 (33.90)	.150 (3.91)	.240 (6.15)	M34x1.0-6g 0.100R	78.00 g
J/25	1.81 (46.00)	1.50 (38.10)	1.38 (34.93)	.79 (20.10)	.008/.130 (2.10/3.20)	1.62 (41.10)	1.45 (36.90)	.150 (3.91)	.240 (6.15)	M37x1.0-6g 0.100R	97.00 g

All dimensions in inches (millimeters in parenthesis)

TYPE 24 JAM-NUT

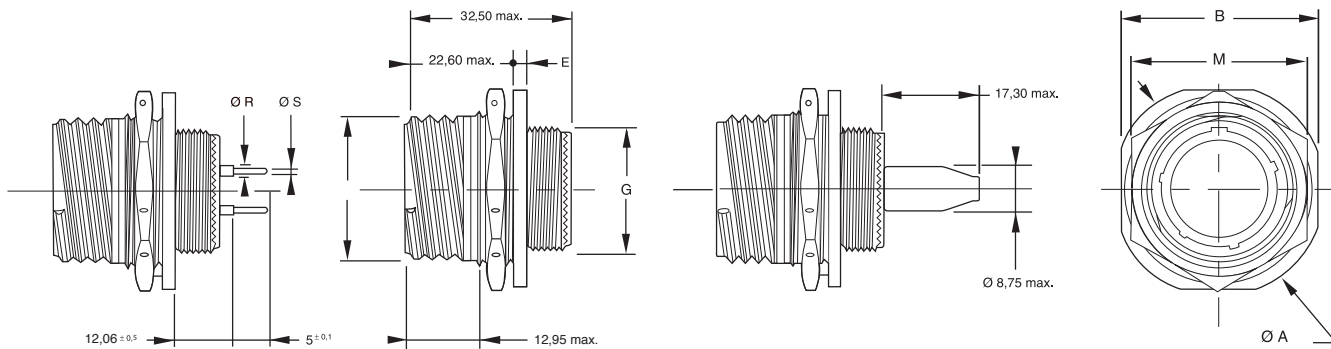

SHELL SIZE	A +/- .012 (+/-0.3)	B +/- .016 (+/-0.4)	E +.004/- .028 (+0.1/-0.7)	F +/- .004 (+/-0.1)	G +/- .004 (+/-0.1)	M MIN./MAX.	REAR METRIC THREAD (PLATED)	MASS MAX.W*
A/9	1.19 (30.20)	1.06 (27.00)	.09 (2.20)	.62 (15.75)	.47 (11.90)	.86/.94 (21.82/24.00)	M12x1.0-6g 0.100R	16.00 g
B/11	1.37 (34.90)	1.25 (31.80)	.09 (2.20)	.74 (18.90)	.59 (14.90)	.98/1.06 (24.99/27.00)	M15x1.0-6g 0.100R	23.00 g
C/13	1.50 (38.10)	1.37 (34.90)	.09 (2.20)	.87 (22.10)	.70 (17.90)	1.17/1.26 (29.77/32.00)	M18x1.0-6g 0.100R	31.00 g
D/15	1.63 (41.30)	1.50 (38.10)	.09 (2.20)	.99 (25.25)	.86 (21.90)	1.30/1.42 (32.91/36.00)	M22x1.0-6g 0.100R	48.00 g
E/17	1.75 (44.50)	1.63 (41.30)	.09 (2.20)	1.18 (29.95)	.98 (24.90)	1.42/1.46 (36.12/37.00)	M25x1.0-6g 0.100R	55.00 g
F/19	1.94 (49.20)	1.81 (46.00)	.12 (3.00)	1.24 (31.55)	1.10 (27.90)	1.55/1.61 (39.25/41.00)	M28x1.0-6g 0.100R	67.00 g
G/21	2.06 (52.40)	1.94 (49.20)	.12 (3.00)	1.37 (34.70)	1.22 (30.90)	1.67/1.81 (42.47/46.00)	M31x1.0-6g 0.100R	81.00 g
H/23	2.19 (55.60)	2.06 (52.40)	.12 (3.00)	1.49 (37.90)	1.33 (33.90)	1.80/1.97 (45.61/50.00)	M34x1.0-6g 0.100R	93.00 g
J/25	2.31 (58.70)	2.19 (55.60)	.12 (3.00)	1.62 (41.10)	1.45 (36.90)	1.94/2.02 (49.25/51.23)	M37x1.0-6g 0.100R	111.00 g

All dimensions in inches (millimeters in parenthesis)

DUMMY RECEPTACLES, DUST CAPS & PLUG CAPS



D38999	DTS	DUMMY RECEPTACLES	RECEPTACLE DUST CAPS		PLUG DUST CAP
			FOR FLANGED	FOR JAM NUT	
A	9	D38999/22A**	D38999/33**9R	D38999/33**9N	D38999/32**9##
B	11	D38999/22B**	D38999/33**11R	D38999/33**11N	D38999/32**11##
C	13	D38999/22C**	D38999/33**13R	D38999/33**13N	D38999/32**13##
D	15	D38999/22D**	D38999/33**15R	D38999/33**15N	D38999/32**15##
E	17	D38999/22E**	D38999/33**17R	D38999/33**17N	D38999/32**17##
F	19	D38999/22F**	D38999/33**19R	D38999/33**19N	D38999/32**19##
G	21	D38999/22G**	D38999/33**21R	D38999/33**21N	D38999/32**21##
H	23	D38999/22H**	D38999/33**23R	D38999/33**23N	D38999/32**23##
J	25	D38999/22J**	D38999/33**25R	D38999/33**25N	D38999/32**25##

** Select Code for Plating

W = Aluminium Olive Drab over Chromate

F = Aluminium Electroless Nickel

K = Stainless Steel

G = Aluminium Electroless Nickel Space Grade

= Select code for ring or loop

N = Ring to attach to backshell as shown

R = Loop for screw mounting

CABLE CLAMPS



D38999	DTS	STRAIGHT		RIGHT ANGLE		CABLE RANGE			
		LOW COST	SELF LOCKING	LOW COST	SELF LOCKING	MIN		MAX	
						INCHES	MM	INCHES	MM
A	9	M85049/38-9**	M85049/38S9**	M85049/39-9**	M85049/39S9**	0.098	2.49	0.234	5.94
B	11	M85049/38-11**	M85049/38S11**	M85049/39-11**	M85049/39S11**	0.153	3.89	0.234	5.94
C	13	M85049/38-13**	M85049/38S13**	M85049/39-13**	M85049/39S13**	0.190	4.83	0.328	8.33
D	15	M85049/38-15**	M85049/38S15**	M85049/39-15**	M85049/39S15**	0.260	6.60	0.457	11.61
E	17	M85049/38-17**	M85049/38S17**	M85049/39-17**	M85049/39S17**	0.283	7.19	0.614	15.60
F	19	M85049/38-19**	M85049/38S19**	M85049/39-19**	M85049/39S19**	0.325	8.25	0.634	16.10
G	21	M85049/38-21**	M85049/38S21**	M85049/39-21**	M85049/39S21**	0.343	8.71	0.698	17.73
H	23	M85049/38-23**	M85049/38S23**	M85049/39-23**	M85049/39S23**	0.381	9.68	0.823	20.90
J	25	M85049/38-25**	M85049/38S25**	M85049/39-25**	M85049/39S25**	0.418	10.62	0.853	21.67

** Select Plating

W = Aluminium Olive Drab over Chromate







F = Aluminium Electroless Nickel

K = Stainless Steel

G = Aluminium Electroless Nickel Space Grade

All dimensions in inches (millimeters in parenthesis)

STANDARD MIL-SPEC

MIL-SPEC PREFIX	SEALED	EMI/RFI	S = STRAIGHT A = 90 DEGREES B = 45 DEGREES	ENDBELL TYPE	DESCRIPTION
M85049/62 	Y	N	S	Heat Shrink Boot Adapters	Designed for use with straight or right angle shrink boots. A knurled rear section with a boot groove provide an excellent surface for the boot to grab the metal endbell. Available with lock wire and drain holes. See Heat Shrink Boots on ↔ See Heat Shrink Boots on pages 168-169.
M85049/32 	N	N	S	Extender Backshell with cable clamp	Non-environmental, designed for use with jacketed cable, allows extra space to break out the wires and still provide strain relief clamping to the outside of the cable jacket.
M85049/17 	Y	Y	S	Environmental Shielded Endbell	This EMI/RFI shielding environmentally sealing endbell features a standard style cable clamp with gland seal at the end of and extender style backshell.
M85049/29 	N	Y	S	Non-Environmental Shielded Endbell	This EMI/RFI shielding non-environmentally sealing endbell features a standard style cable clamp.
M85049/85 M85049/86 M85049/87 	Y	Y	S B A	Banding Adapter	Banding adapters utilize a band of metal that fastens and grounds cable shields to the outside of endbells. This method of terminating shields has advantages in that they typically use tools to tighten trim the bands. These tools make the termination tight, repeatable, reworkable (if you make a mistake just cut the band off and start again) and facilitates service. Banding adapters help lower the total applied cost by having simpler designs that have fewer parts with uncomplicated assembly procedures.
M85049/27 	N	N	S	Compression Nut	Wire Seal Compression Nut

NOTE: If military-standard versions won't work for your applications, please contact us with your requirements.

WIRE STRIPPING

Strip insulation from end of wire to be crimped. (See table for proper stripping dimensions.) Do not cut or damage wire strands.

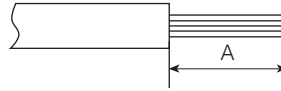

WIRE SIZE	A
22, 22M, 22D	.125 (3.18)
20	.188 (4.77)
16	.188 (4.77)
12	.188 (4.77)
10	.335 (8.51)
8 (power)	.470 (11.99)

CONTACT CRIMPING

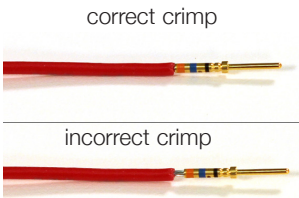

STEP 1: Strip wires. See above for correct strip length for contact. Insert wire into rear of contact. Wire insulation must push against rear of contact. Wire must be visible through inspection hole.

STEP 2: M22520 series crimp tool and locator is recommended. → See page 68 here for choice of turret head and selection setting according to correct size, part number and wire gauge size.

STEP 3: Insert contact and wire into tool jaws. To crimp, squeeze handles together fully until ratchet releases and allows handles to expand; otherwise, contact cannot be extracted from tool jaws. Maintain slight insertion pressure on wire while crimping contact to wire.*

CONTACT INSERTION

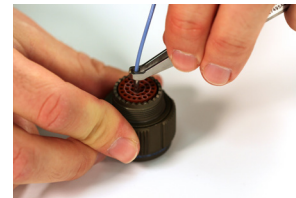
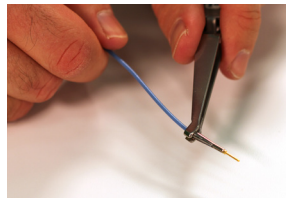
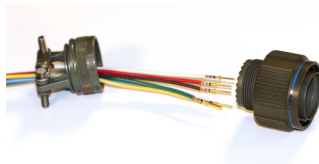

STEP 1: Remove hardware from plug or receptacle and slip over wire bundle in proper order for reassembly.

STEP 2: Using proper plastic or metal insertion tool for corresponding contact, position wire in tip of the tool so that the tool tip presses against the contact shoulder.

STEP 3: Press tool against contact shoulder and, with firm and even pressure, insert wired contact and tool tip into center contact cavity.

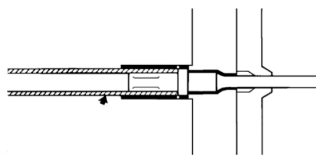

STEP 4: When contact bottoms, a slight "click" can be heard as tines of metal retaining clip snap into place behind contact shoulder.

STEP 5: Remove tool and pull back lightly on wire to make sure contact is properly seated. Repeat operation with remainder of contacts to be inserted, beginning with the center cavity and working outward in alternating rows.

STEP 6: After all contacts are inserted, fill any empty cavities with wire sealing plugs. Reassemble plug or receptacle hardware.

ASSEMBLY INSTRUCTIONS

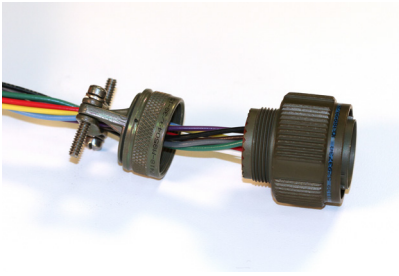

STEP 1: Remove hardware from plug or receptacle and slide hardware back along wire bundle.

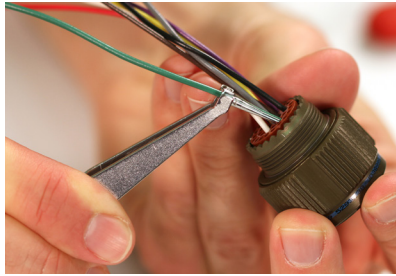

STEP 2: Using plastic or metal extraction tool with proper color code corresponding to contact size, place wire in tool.

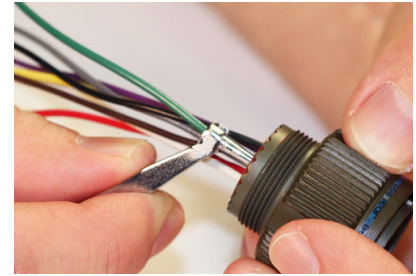

STEP 3: Insert tool into contact cavity until tool tip bottoms against the contact shoulder, expanding clip retaining tines.

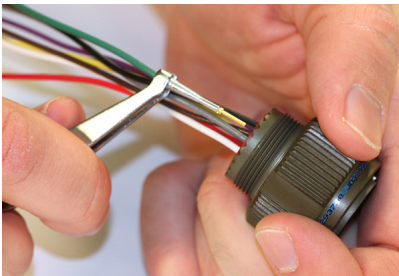

STEP 4: Hold wire firmly in tool and extract wired contact and tool. Repeat operation for all contacts to be extracted.

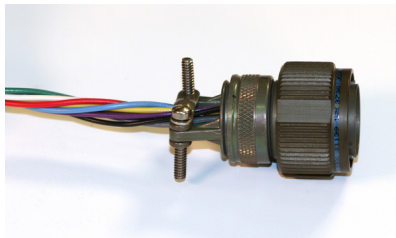

STEP 5: Fill any empty cavities with wire sealing plugs. Reassemble plug or receptacle hardware.

Note: DTS series shown.

TE Connectivity DEUTSCH ACT Series MIL-DTL-38999 Series III Composite Connectors



INTERMATEABLE WITH SOURIAU CONNECTORS AND ALL MIL-DTL-38999 SERIES III

TE DEUTSCH ACT series MIL-DTL-38999 series III composite connectors offer high density contact arrangements in a miniature circular connector composed of composite materials. ACT connectors meet MIL-38999 and were originally designed as military and aerospace components. The DEUTSCH ACT series is now being used in many applications requiring extremely reliable interconnections. These DEUTSCH connectors are quick-mating, environmentally-sealed, triple-lead threaded, have a self-locking coupling, and are EMI-RFI-shielded. A variety of D38999 backshells are available. For full product details on the DEUTSCH ACT series MIL-DTL-38999 series III composite connectors, please see the specifications below.

APPLICATIONS

- High-performance military aircraft
- Commercial aircraft
- Communications equipment
- Armored personnel carriers & tanks
- High temperature industrial equipment
- Missiles
- Shipboard

FEATURES

- High reliability
- Outstanding/RFI shielding protection
- High density
- Self-locking connector systems
- MIL-DTL-38999
- Scoop-proof contact protection
- Light-weight

MATERIALS AND FINISHES

Shell	Composite
Shell Plating	Electroless nickel and olive drab chromate over nickel
Contacts	Copper alloy
Contact Platings	50u" gold plated
Insulator	Rigid plastic dielectric
Seals	Fluorinated silicone based elastomer

ELECTRICAL DATA

Wire Range Sizes	12-24AWG
Insulation Resistance	5000 Megaohms minimum at 77°F (25°C)

Contact Resistance Of Mated Contacts End To End

CONTACT SIZE	MAXIMUM MILLIVOLT DROP
22D	40
20	35
16	25
12	25

Test Voltage ac rms

SERVICE RATING	SEA LEVEL		100,000 FEET ALTITUDE	
	MATED	UNMATED	MATED	UNMATED
M	1300	1300	800	200
N	1000	1000	600	200
I	1800	1800	1000	200
II	2300	2300	1000	200

Current Rating

WIRE SIZE	CONTACT SIZE	MAX. CURRENT FOR TEST IN AMPS	POTENTIAL DROP MILLIVOLT AT 77°F (25°C)
24	20	3	<45
20	20	7.5	<55
20	16	7.5	<45
16	16	13	<50
14	12	17	<45
12	12	23	<50

MECHANICAL DATA

Operating Temperature	J - Olive drab composite -65°C to +175°C (-85°F to +347°F) M - Electroless nickel composite -65°C to +200°C (-85°F to +392°F)
Sealing	Against sand, dust per MIL-STD-202 & ice resistance

MECHANICAL DATA

Wire Sealing Range

CONTACT SIZE	MINIMUM		MAXIMUM	
	INCHES	MM	INCHES	MM
22D	0.030	0.76	0.054	1.37
20	0.040	1.02	0.83	2.11
16	0.065	1.65	0.109	2.77
12	0.097	2.46	0.142	3.61
8 (Coax)	0.135	3.43	0.155	3.94
8 (Twinax)	0.124	3.15	0.134	3.4

Insulation Strip Length

CONTACT SIZE	STRIP LENGTH	
	INCHES	MM
22D	0.125	3.18
20	0.188	4.77
16	0.188	4.77
12	0.188	4.77

Mating Life	1500 mating cycle with high mating cycle, 500 mating cycle with typical P and S contacts
Salt Spray	2000 hours per MIL-STD-1344A method 1001 condition C
Temp Durability	J - Olive drab composite +175°C (+347°F) M - Electroless nickel composite +200°C (+392°F)
Chemical Resistance	Lubricating oils, hydraulic fluids, coolants, deicing fluids per MIL-STD-1344A Method 1016 condition a-1
Sine Vibration	60g at -55°C per MIL-DTL-38999L 4.5.23.2.1
Random Vibration	49.5 grms at ambient temperatures
Shock	300 grms
EMI Shielding Effectiveness	100 MHz to 10 GHz - minimum attenuation of 50dB
Contact Type	Crimp, fiber optic, coax, twinax, or printed circuit
Number of Circuits	2 to 128
Contact Insertion	Rear insertion/Rear extraction with simple plastic or high quality metal hand tools.
Polarization	Five keyways with optional master keyway rotations (Note insert and main keyways remain fixed)
Approvals	MIL-DTL-38999

Contact Retention

CONTACT SIZE	RETENTION AXIAL LOAD +/- 10 PERCENT		SEPARATION FORCE MINIMUM (INITIAL)	
	NEWTONS	LBS.	NEWTONS	OUNCES
22D	44	10	0.19	0.7
20	15	67	0.19	0.7
16	25	111	0.56	2
12	25	111	0.83	3
8	25	111	1.39	5
8 Twinax	25	111	1.39	5

HOW TO ORDER ACT/38999 SERIES CONNECTORS

1	2	3	4	5	6
ACT20	M	A35	P	A	-LC
SHELL STYLE	FINISH	LAYOUT	CONTACT	KEYING	MODIFIER

(Commercial part number example)

1	2	3	4	5	6
D38999/20	M	A35	P	A	-LC
SHELL STYLE	FINISH	LAYOUT	CONTACT	KEYING	MODIFIER

(Military part number example)

STEP 1: SELECT SHELL STYLE, PLUG OR RECEPTACLE



STEP 2: SELECT FINISH

Military

- M = Electroless Nickel
- OR
- J = Olive Drab Chromate over Cadmium

Commercial

- M = Electroless Nickel
- OR
- W = Olive Drab Chromate over Cadmium

STEP 3: SELECT LAYOUT

⇒ See page 80 for listing by # of contacts

MILITARY LAYOUT	RATING	TOTAL	22D	20	16	12	12 COAX	8
A35	M	6	6					
A98	I	3		3				
B2		2			2			
B5	I	5		5				
B35	M	13	13					
B98	I	6		6				
B99	I	7		7				
C4	I	4			4			
C8	I	8		8				
C35	M	22	22					
C98	I	10		10				
D5	II	5			5			
D15	I	15		14	1			
D18	I	18		18				
D19	I	19		19				
D35	M	37	37					
D97	I	12		8	4			
E2	M	39	38					1**
E6	I	6				6		
E8	II	8			8			
E26	I	26		26				
E35	M	55	55					
E99	I	23		21	2			
F11	II	11			11			
F32	I	32		32				
F35	M	66	66					
G11	I	11				11		
G16	II	16			16			
G35	M	79	79					
G39	I	39		37	2			
G41	I	41		41				
G75	N	4						4*
H21	II	21			21			
H35	M	100	100					
H53	I	53		53				
H55	I	55		55				
J4	I	56		48	8			
J7	TWINAX	99	97					2**
J8	TWINAX	8						8**
J19	I	19				19		
J20	N	30		10	13		4*	3**
J24	I	24			12	12		
J29	I	29			29			
J35	M	128	128					
J43	I	43		23	20			
J61	I	61		61				
J90	I	46		40	4			2**

* Coax ** Twinax

STEP 4: SELECT CONTACT

- P** = Pin
- S** = Socket
- H** = 1500 cycle Pin contacts
- J** = 1500 cycle Socket contacts
- Note:** See Step 6 if you are not ordering contacts with part.
- A** = Less Pin Contacts
- B** = Less Socket Contacts
May be used for special contact types (PC Pin, Thermocouple, Fiberoptic).
- U** = PCB Pin contacts (ACT only)
- M** = PCB socket contacts (ACT only)

STEP 5: SELECT POLARIZATION

- N** = Normal (Standard)
- A** = Next Most Popular
- B** = Not Popular (limited availability)
- C** = Check for availability
- D** = Check for availability
- E** = Check for availability

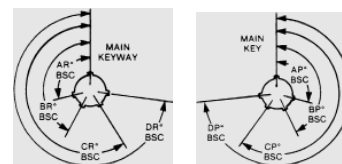

SHELL SIZE	POLARIZATION	MINOR KEY LOCATIONS				
		AR & AP	BR & BP	CR & CP	DR & DP	
9	N	105	140	215	265	
	A	102	132	248	320	
	B	80	118	230	312	
	C	35	140	205	275	
	D	64	155	234	304	
11	E	91	131	197	240	
	N	95	141	208	236	
	13	A	113	156	182	292
		B	90	145	195	252
		C	53	156	220	255
D		119	146	176	298	
E		51	141	184	242	
15	N	80	142	196	293	
	A	135	170	200	310	
	B	49	169	200	244	
	C	66	140	200	257	
	D	62	145	180	280	
17	E	79	153	197	272	
	N	80	142	196	293	
	19	A	135	170	200	310
		B	49	169	200	244
		C	66	140	200	257
D		62	145	180	280	
E		79	153	197	272	
21	N	80	142	196	293	
	23	A	135	170	200	310
		B	49	169	200	244
		C	66	140	200	257
		D	62	145	180	280
25		E	79	153	197	272

STEP 6: SELECT MODIFIER

For other commercial modification, i.e., less tools, with PC contact or with endbell, call.

- Omit for standard contacts
- LC** = for use with standard contacts, but supplied without contacts, seal plugs or tools (PO must state Less Contacts)
- Note:** -LC is not marked on part
- 3025 = Standard 500 mating cycle contact (ACT only)

LAYOUTS BY SHELL SIZE

LAYOUT								
# OF CONTACTS	A-35 6 - #22	A-98 3 - #20	B-02 2 - #16	B-05 5 - #20	B-35 13 - #22	B-98 6 - #20	B-99 7 - #20	C-04 4 - #16
SERVICE RATING	M	I		I	M	I	I	I
LAYOUT								
# OF CONTACTS	C-08 8 - #20	C-35 22 - #22	C-98 10 - #20	D-05 5 - #16	D-15 14 - #20, 1 - #16	D-18 18 - #20	D-19 19 - #20	D-35 37 - #22
SERVICE RATING	I	M	I	II	I	I	I	M
LAYOUT								
# OF CONTACTS	D-97 8 - #20, 4 - #16	E-02 38 - #22, 1 - #8	E-06 6 - #12	E-08 8 - #16	E-26 26 - #20	E-35 55 - #22	E-99 21 - #20	F-11 11 - #16
SERVICE RATING	I	M	I	II	I	M	I	II
LAYOUT								
# OF CONTACTS	F-32 32 - #20	F-35 66 - #22	G-11 11 - #12	G-16 16 - #16	G-35 79 - #22	G-39 2 - #16, 37 - #20	G-41 41 - #20	G-75 4 - #8
SERVICE RATING	I	M	I	II	M	I	I	N
LAYOUT								
# OF CONTACTS	H-21 21 - #16	H-35 100 - #22	H-53 53 - #20	H-55 55 - #20	J-04 48 - #20, 8 - #16	J-7 97 - #22, 2 - #8	J-8 8 - #8	
SERVICE RATING	I	M	I	I	I	TWINAX	TWINAX	
LAYOUT								
# OF CONTACTS	J-19 19 - #12	J-20* 10 - #20, 13 - #16, 4 - #12, 3 - #8	J-24 12 - #16, 12 - #12	J-29 29 - #16	J-35 128 - #22	J-43 23 - #20, 20 - #16	J-61 61 - #20	
SERVICE RATING	I	N	I	I	M	I	I	
LAYOUT								
# OF CONTACTS	J-90 40 - #20, 4 - #16, 2 - #8							
SERVICE RATING	I							

• =22 ○ =20 ◊ =16 ▲ =12 ⊕ =8

PINS

CONTACT SIZE	WIRE CRIMP SIZE RANGE	PIN PART NUMBER	COLOR BANDS			WIRE STRIP LENGTHS		WIRE INSULATION SEALING RANGE				WIRE HOLE FILLER	WIRE HOLE FILLER COLOR
			1	2	3	IN.	MM	MIN. IN.	MIN. MM	MAX. IN.	MAX. MM		
22D	28,26,24,22	M39029/58-360	Orange	Blue	Black	0.125	3.18	0.030	0.760	0.054	1.37	MS27488-22-2	Black
20	24,22,20	M39029/58-363	Orange	Blue	Orange	0.188	4.77	0.040	1.020	0.083	2.11	MS27488-20-2	Red
16	20,18,16	M39029/58-364	Orange	Blue	Yellow	0.188	4.77	0.065	1.65	0.109	2.77	MS27488-16-2	Blue
12	14,12	M39029/58-365	Orange	Blue	Green	0.188	4.77	0.097	2.46	0.142	3.61	MS27488-12-2	Yellow

SOCKETS

CONTACT SIZE	WIRE CRIMP SIZE RANGE	SOCKET PART NUMBER	COLOR BANDS			WIRE STRIP LENGTHS		WIRE INSULATION SEALING RANGE				WIRE HOLE FILLER	WIRE HOLE FILLER COLOR
			1	2	3	IN.	MM	MIN. IN.	MIN. MM	MAX. IN.	MAX. MM		
22D	28,26,24,22	M39029/56-348	Orange	Yellow	Gray	0.125	3.18	0.030	0.760	0.054	1.37	MS27488-22-2	Black
20	24,22,20	M39029/56-351	Orange	Green	Brown	0.188	4.77	0.040	1.020	0.083	2.11	MS27488-20-2	Red
16	20,18,16	M39029/56-352	Orange	Green	Red	0.188	4.77	0.065	1.65	0.109	2.77	MS27488-16-2	Blue
12	14,12	M39029/56-353	Orange	Green	Orange	0.188	4.77	0.097	2.46	0.142	3.61	MS27488-12-2	Yellow

CONTACT TOOLS

PINS

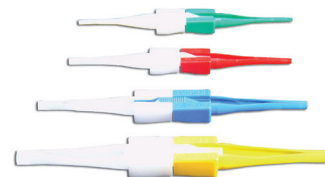

CONTACT SIZE	HAND CRIMP TOOL	TURRET HEAD (LOCATOR)	TURRET HEAD (LOCATOR) COLOR	POWER CRIMP TOOL	POWER TOOL LOCATOR	METAL		PLASTIC		
						INSERTION TOOL	EXTRACTION TOOL	INSERTION/ EXTRACTION TOOL	INSERTION TIP COLOR	EXTRACTION TIP COLOR
22D	M22520/2-01	M22520/2-09	-	WA22	M22520/2-09	MS27495A22M	MS27495A22M	M81969/14-01	Green	White
20	M22520/1-01	M22520/1-04	Red	WA27F	M22520/1-04	MS27495A20	MS27495A20	M81969/14-10	Red	Orange
16	M22520/1-01	M22520/1-04	Blue	WA27F	M22520/1-04	MS27495A16	MS27495A16	M81969/14-03	Blue	White
12	M22520/1-01	M22520/1-04	Yellow	WA27F	M22520/1-04	DAK95-12B	DRK95-12B	M81969/14-04	Yellow	White

SOCKETS

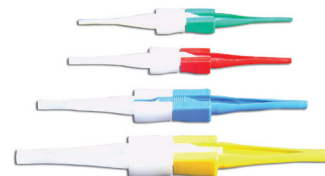

CONTACT SIZE	HAND CRIMP TOOL	TURRET HEAD (LOCATOR)	TURRET HEAD (LOCATOR) COLOR	POWER CRIMP TOOL	POWER TOOL LOCATOR	METAL		PLASTIC		
						INSERTION TOOL	EXTRACTION TOOL	INSERTION/ EXTRACTION TOOL	INSERTION TIP COLOR	EXTRACTION TIP COLOR
22D	M22520/2-01	M22520/2-09	-	WA22	M22520/2-09	MS27495A22M	MS27495A22M	M81969/14-01	Green	White
20	M22520/1-01	M22520/1-04	Red	WA27F	M22520/1-04	MS27495A20	MS27495A20	M81969/14-10	Red	Orange
16	M22520/1-01	M22520/1-04	Blue	WA27F	M22520/1-04	MS27495A16	MS27495A16	M81969/14-03	Blue	White
12	M22520/1-01	M22520/1-04	Yellow	WA27F	M22520/1-04	DAK95-12B	DRK95-12B	M81969/14-04	Yellow	White

TYPE 26 PLUG

D38999/26
ACT 26

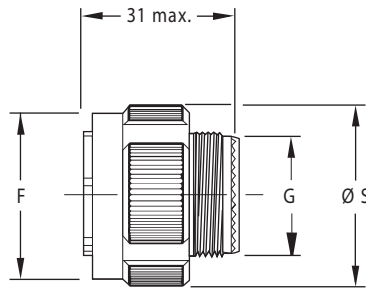

SHELL SIZE	F MAX.	G MAX.	S MAX.	REAR METRIC THREAD (PLATED)	MASS MAX.*
A/9	.720 (18.4)	.470 (11.9)	.860 (21.8)	M12x1.0-6g 0.100R	9.00 g
B/11	.830 (21.1)	.590 (14.9)	.980 (25.0)	M15x1.0-6g 0.100R	13.00 g
C/13	1.00 (25.4)	.700 (17.9)	1.16 (29.4)	M18x1.0-6g 0.100R	18.00 g
D/15	1.13 (28.7)	.860 (21.9)	1.28 (32.5)	M22x1.0-6g 0.100R	23.00 g
E/17	1.27 (32.2)	.980 (24.9)	1.41 (35.7)	M25x1.0-6g 0.100R	25.00 g
F/19	1.37 (34.9)	1.10 (27.9)	1.52 (38.5)	M28x1.0-6g 0.100R	32.00 g
G/21	1.50 (38.1)	1.22 (30.9)	1.64 (41.7)	M31x1.0-6g 0.100R	35.00 g
H/23	1.62 (41.1)	1.33 (33.9)	1.77 (44.9)	M34x1.0-6g 0.100R	41.00 g
J/25	1.74 (44.3)	1.45 (36.9)	1.89 (48.0)	M37x1.0-6g 0.100R	48.00 g

*Mass without contacts

TYPE 20 SQUARE FLANGE

D38999/20
ACT 20

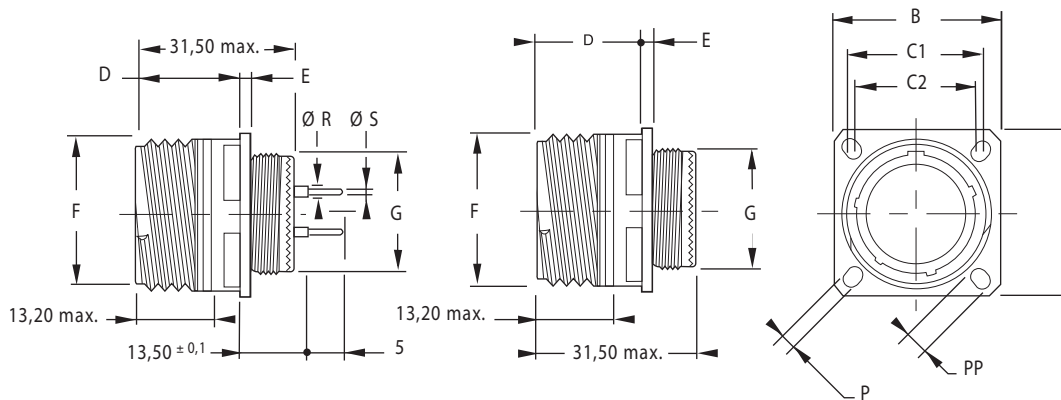

SHELL SIZE	B +/--.012 (+/-0.3)	C1	C2	D MAX.	F +/--.004 (+/-0.1)	G +/--.004 (+/-0.1)	P +/--.008 (+/-0.2)	PP +/--.008 (+/-0.2)	REAR METRIC THREAD (PLATED)	MASS MAX.*
A/9	.94 (23.80)	.72 (18.26)	.59 (15.09)	.77 (19.50)	.620 (15.75)	.470 (11.90)	.130 (3.25)	.220 (5.49)	M12x1.0-6g 0.100R	8.00 g
B/11	1.03 (26.20)	.81 (20.62)	.72 (18.26)	.77 (19.50)	.740 (18.90)	.590 (14.90)	.130 (3.25)	.190 (4.93)	M15x1.0-6g 0.100R	11.00 g
C/13	1.13 (28.60)	.91 (23.01)	.81 (20.62)	.77 (19.50)	.870 (22.10)	.700 (17.90)	.130 (3.25)	.190 (4.93)	M18x1.0-6g 0.100R	14.00 g
D/15	1.22 (31.00)	.97 (24.61)	.91 (23.01)	.77 (19.50)	.990 (25.25)	.860 (21.90)	.130 (3.25)	.190 (4.93)	M22x1.0-6g 0.100R	18.00 g
E/17	1.31 (33.30)	1.06 (26.97)	.97 (24.61)	.77 (19.50)	1.18 (29.95)	.980 (24.90)	.130 (3.25)	.190 (4.93)	M25x1.0-6g 0.100R	23.00 g
F/19	1.44 (36.50)	1.16 (29.36)	1.06 (26.97)	.77 (19.50)	1.24 (31.55)	1.10 (27.90)	.130 (3.25)	.190 (4.93)	M28x1.0-6g 0.100R	26.00 g
G/21	1.56 (39.70)	1.25 (31.75)	1.16 (29.36)	.74 (18.70)	1.37 (34.70)	1.22 (30.90)	.130 (3.25)	.190 (4.93)	M31x1.0-6g 0.100R	31.00 g
H/23	1.69 (42.90)	1.38 (34.93)	1.25 (31.75)	.74 (18.70)	1.49 (37.90)	1.33 (33.90)	.150 (3.91)	.240 (6.15)	M34x1.0-6g 0.100R	36.00 g
J/25	1.81 (46.00)	1.50 (38.10)	1.38 (34.93)	.74 (18.70)	1.62 (41.10)	1.45 (36.90)	.150 (3.91)	.240 (6.15)	M37x1.0-6g 0.100R	43.00 g

*Mass without contacts

All dimensions in inches (millimeters in parenthesis)

DIMENSIONS

TYPE 24 JAM-NUT

D38999/24
ACT 24

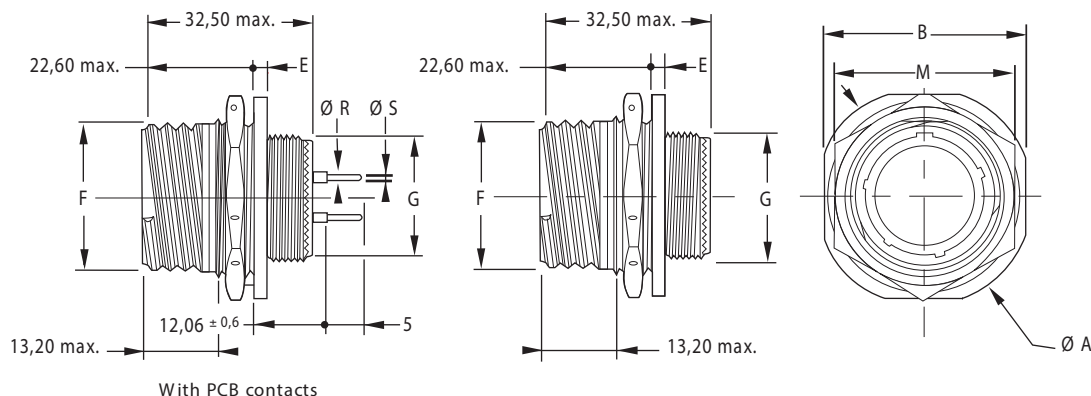

SHELL SIZE	A +/- .012 (+/-0.3)	B +/- .016 (+/-0.4)	E +.004/- .028 (+0.1/-0.7)	F +/- .004 (+/-0.1)	G +/- .004 (+/-0.1)	M	REAR METRIC THREAD (PLATED)	MASS MAX.*
A/9	1.19 (30.20)	1.06 (27.00)	.12 (3.00)	.62 (15.75)	.47 (11.90)	.86 (21.82)	M12x1.0-6g 0.100R	11.00 g
B/11	1.37 (34.90)	1.25 (31.80)	.12 (3.00)	.74 (18.90)	.59 (14.90)	.98 (24.99)	M15x1.0-6g 0.100R	14.00 g
C/13	1.50 (38.10)	1.37 (34.90)	.12 (3.00)	.87 (22.10)	.70 (17.90)	1.17 (29.77)	M18x1.0-6g 0.100R	18.00 g
D/15	1.63 (41.30)	1.50 (38.10)	.12 (3.00)	.99 (25.25)	.86 (21.90)	1.30 (32.91)	M22x1.0-6g 0.100R	23.00 g
E/17	1.75 (44.50)	1.63 (41.30)	.12 (3.00)	1.18 (29.95)	.98 (24.90)	1.42 (36.12)	M25x1.0-6g 0.100R	29.00 g
F/19	1.94 (49.20)	1.81 (46.00)	.15 (3.70)	1.24 (31.55)	1.10 (27.90)	1.55 (39.25)	M28x1.0-6g 0.100R	35.00 g
G/21	2.06 (52.40)	1.94 (49.20)	.15 (3.70)	1.37 (34.70)	1.22 (30.90)	1.67 (42.47)	M31x1.0-6g 0.100R	38.00 g
H/23	2.19 (55.60)	2.06 (52.40)	.15 (3.70)	1.49 (37.90)	1.33 (33.90)	1.80 (45.61)	M34x1.0-6g 0.100R	46.00 g
J/25	2.31 (58.70)	2.19 (55.60)	.15 (3.70)	1.62 (41.10)	1.45 (36.90)	1.94 (49.25)	M37x1.0-6g 0.100R	55.00 g

*Mass without contacts

All dimensions in inches (millimeters in parenthesis)

DUMMY RECEPTACLES, DUST CAPS & PLUG CAPS

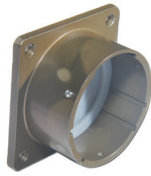

D38999	DTS	DUMMY RECEPTACLES	RECEPTACLE DUST CAPS		PLUG DUST CAP
			FOR FLANGED	FOR JAM NUT	
A	9	D38999/22A**	D38999/33**9R	D38999/33**9N	D38999/32**9##
B	11	D38999/22B**	D38999/33**11R	D38999/33**11N	D38999/32**11##
C	13	D38999/22C**	D38999/33**13R	D38999/33**13N	D38999/32**13##
D	15	D38999/22D**	D38999/33**15R	D38999/33**15N	D38999/32**15##
E	17	D38999/22E**	D38999/33**17R	D38999/33**17N	D38999/32**17##
F	19	D38999/22F**	D38999/33**19R	D38999/33**19N	D38999/32**19##
G	21	D38999/22G**	D38999/33**21R	D38999/33**21N	D38999/32**21##
H	23	D38999/22H**	D38999/33**23R	D38999/33**23N	D38999/32**23##
J	25	D38999/22J**	D38999/33**25R	D38999/33**25N	D38999/32**25##

** Select Code for Plating

J = Composite Olive Drab over Chromate

M = Composite Electroless Nickel

F = Aluminium Electroless Nickel

W = Aluminium Olive Drab over Chromate

= Select code for ring or loop

N = Ring to attach to backshell as shown

R = Loop for screw mounting

CABLE CLAMPS



D38999	DTS	STRAIGHT		RIGHT ANGLE		CABLE RANGE	
		LOW COST	NON- DETENT	LOW COST	NON- DETENT	INCHES	MM
A	9	M85049/91-9**	M85049/91S9**	M85049/92-9**	M85049/92S9**	0.219	5.56
B	11	M85049/91-11**	M85049/91S11**	M85049/92-11**	M85049/92S11**	0.264	6.71
C	13	M85049/91-13**	M85049/91S13**	M85049/92-13**	M85049/92S13**	0.344	8.74
D	15	M85049/91-15**	M85049/91S15**	M85049/92-15**	M85049/92S15**	0.460	11.68
E	17	M85049/91-17**	M85049/91S17**	M85049/92-17**	M85049/92S17**	0.545	13.84
F	19	M85049/91-19**	M85049/91S19**	M85049/92-19**	M85049/92S19**	0.615	15.62
G	21	M85049/91-21**	M85049/91S21**	M85049/92-21**	M85049/92S21**	0.698	17.73
H	23	M85049/91-23**	M85049/91S23**	M85049/92-23**	M85049/92S23**	0.700	17.78
J	25	M85049/91-25**	M85049/91S25**	M85049/92-25**	M85049/92S25**	0.850	21.59

** Select Plating

J = Composite Olive Drab over Chromate

M = Composite Electroless Nickel







T = Composite without plating

F = Aluminium Electroless Nickel

W = Aluminium Olive Drab over Chromate

All dimensions in inches (millimeters in parenthesis)

STANDARD MIL-SPEC

MIL-SPEC PREFIX	SEALED	EMI/RFI	S = STRAIGHT A = 90 DEGREES B = 45 DEGREES	ENDBELL TYPE	DESCRIPTION
M85049/69 	Y	N	S	Heat Shrink Boot Adapters	Designed for use with straight or right angle shrink boots. A knurled rear section with a boot groove provide an excellent surface for the boot to grab the metal endbell. Available with lock wire and drain holes. See Heat Shrink Boots on ↔ See Heat Shrink Boots on pages 168-169.
M85049/21 	N	N	S	Extender Backshell with cable clamp	Non-environmental, designed for use with jacketed cable, allows extra space to break out the wires and still provide strain relief clamping to the outside of the cable jacket.
M85049/18 	Y	Y	S	Environmental Shielded Endbell	This EMI/RFI shielding environmentally sealing endbell features a standard style cable clamp with gland seal at the end of and extender style backshell.
M85049/19 	N	Y	S	Non-Environmental Shielded Endbell	This EMI/RFI shielding non-environmentally sealing endbell features a standard style cable clamp.
M85049/88 M85049/89 M85049/88 	Y	Y	S B A	Banding Adapter	Banding adapters utilize a band of metal that fastens and grounds cable shields to the outside of endbells. This method of terminating shields has advantages in that they typically use tools to tighten trim the bands. These tools make the termination tight, repeatable, reworkable (if you make a mistake just cut the band off and start again) and facilitates service. Banding adapters help lower the total applied cost by having simpler designs that have fewer parts with uncomplicated assembly procedures.
M85049/14S 	N	N	S	Compression Nut	Wire Seal Compression Nut

NOTE: If military-standard versions won't work for your applications, please contact us with your requirements.

WIRE STRIPPING

Strip insulation from end of wire to be crimped. (See table for proper stripping dimensions.) Do not cut or damage wire strands.

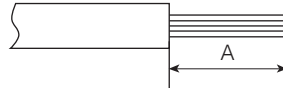

WIRE SIZE	A
22, 22M, 22D	.125 (3.18)
20	.188 (4.77)
16	.188 (4.77)
12	.188 (4.77)
10	.335 (8.51)
8 (power)	.470 (11.99)

CONTACT CRIMPING

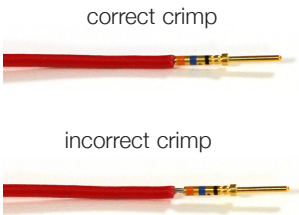

STEP 1: Strip wires. See above for correct strip length for contact. Insert wire into rear of contact. Wire insulation must push against rear of contact. Wire must be visible through inspection hole.

STEP 2: M22520 series crimp tool and locator is recommended. → See page 82 for choice of turret head and selection setting according to correct size, part number and wire gauge size.

STEP 3: Insert contact and wire into tool jaws. To crimp, squeeze handles together fully until ratchet releases and allows handles to expand; otherwise, contact cannot be extracted from tool jaws. Maintain slight insertion pressure on wire while crimping contact to wire.

CONTACT INSERTION

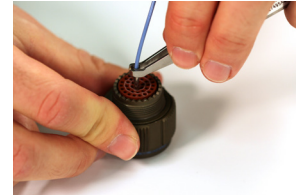
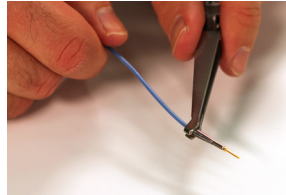
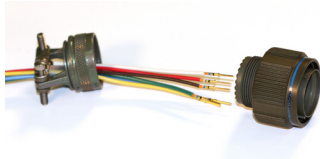

STEP 1: Remove hardware from plug or receptacle and slip over wire bundle in proper order for reassembly.

STEP 2: Using proper plastic or metal insertion tool for corresponding contact, position wire in tip of the tool so that the tool tip presses against the contact shoulder.

STEP 3: Press tool against contact shoulder and, with firm and even pressure, insert wired contact and tool tip into center contact cavity.

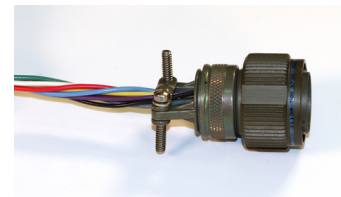
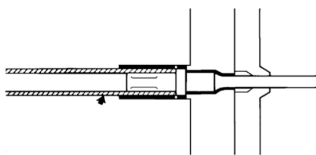

STEP 4: When contact bottoms, a slight "click" can be heard as tines of metal retaining clip snap into place behind contact shoulder.

STEP 5: Remove tool and pull back lightly on wire to make sure contact is properly seated. Repeat operation with remainder of contacts to be inserted, beginning with the center cavity and working outward in alternating rows.

STEP 6: After all contacts are inserted, fill any empty cavities with wire sealing plugs. Reassemble plug or receptacle hardware.

ASSEMBLY INSTRUCTIONS

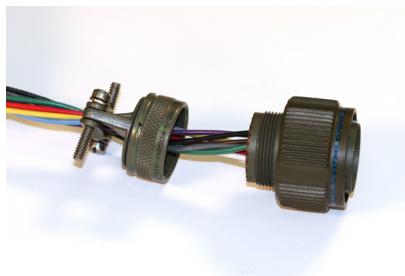

STEP 1: Remove hardware from plug or receptacle and slide hardware back along wire bundle.

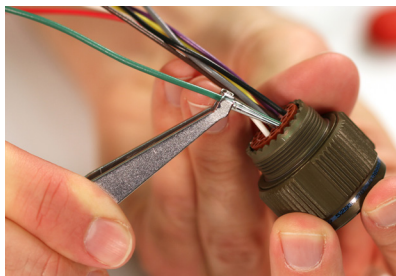

STEP 2: Using plastic or metal extraction tool with proper color code corresponding to contact size, place wire in tool.

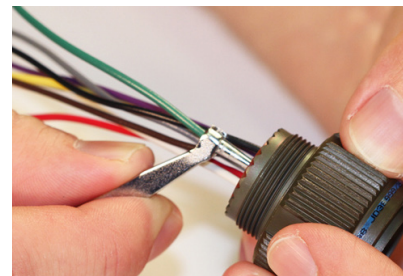

STEP 3: Insert tool into contact cavity until tool tip bottoms against the contact shoulder, expanding clip retaining lines.

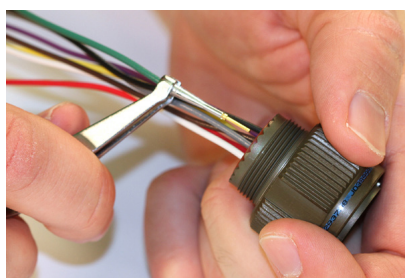

STEP 4: Hold wire firmly in tool and extract wired contact and tool. Repeat operation for all contacts to be extracted.

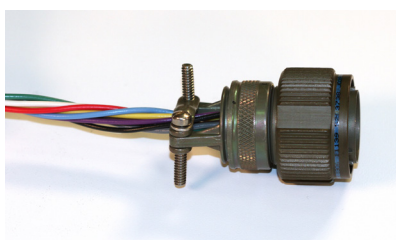

STEP 5: Fill any empty cavities with wire sealing plugs. Reassemble plug or receptacle hardware.

Note: DTS series shown.

TE Connectivity DEUTSCH DL Series MIL-DTL-83723 Series III Connectors



INTERMATEABLE WITH SOURIAU CONNECTORS AND ALL MIL-DTL-83723 SERIES III

TE DEUTSCH DL series MIL-DTL-83723 series III connectors have a quick-mating, three-point bayonet coupling system. TE DEUTSCH DL series connectors are designed for the harsh environments found in communications equipment, industrial equipment, and armored tanks, and are excellent aerospace connectors. These TE DEUTSCH connectors are mil spec to MIL-83723 and have a high-quality contact retention system. The DL series is intermateable with Souriau connectors, all MIL-DTL-83723 series III connectors, and all MIL-DTL-26500 bayonet connectors. For full product details on the TE DEUTSCH DL series MIL-DTL-83723 series III connectors, please see the specifications below.

APPLICATIONS

- High-performance military aircraft
- Commercial aircraft
- Communications equipment
- Armored personnel carriers & tanks
- High temperature industrial equipment

FEATURES

- High-reliability
- Outstanding EMI-shielding protection
- Operates at extreme temperatures
- High-density connectors
- Broad range of military and commercial accessories
- MIL-DTL-83723 qualified

MATERIALS AND FINISHES

Shell	Aluminium Alloy or Stainless Steel
Shell Plating	Electroless Nickel, Olive Drab Chromate over nickel, Anodized, and Passivated
Bayonet Pin	Passivated Stainless Steel
Contacts	Copper Alloy
Contact Platings	50u" Gold Plated
Insulator	Rigid Plastic dielectric
Seals	Silicone based elastomer

ELECTRICAL DATA

Test Voltage

SERVICE RATING	SEA LEVEL VAC RMS	50000 FEET ALTITUDE VAC RMS	70000 FEET ALTITUDE VAC RMS	110000 FEET ALTITUDE VAC RMS
I	1500	500	375	200
II	2300	750	500	200

Current Rating

CONTACT SIZE	DC TEST CURRENT IN AMPS	POTENTIAL DROP MILLIVOLT AT 77°F (25°C)
20	7.5	<15
16	13	<21
12	23	<22

MECHANICAL DATA

Wire Range Sizes	12-24AWG
Insulation Resistance	5000 Megaohms minimum at 77°F (25°C)
Mating Life	500 cycle minimum
Salt Spray	48 hours unmated; 452 hours mated
Heat	Class A,R, & G +392°F (200°C), Class W +347°F (175°C) for 1000 hours
Vibration	10 to 2000Hz (20g's) 1 microseconds maximum discontinuity.
Shock	300g's for 3 microseconds duration, 1 microsecond maximum discontinuity
Contact Type	Crimp, coax, shielded, printed circuit board, thermocouple, and fiber optic
Number of Circuits	3 to 61
Polarization	Five keyway, three point bayonet with optional keyed polarization shells or rotation of insert
Approvals/Agency Listing	MIL-DTL-83723

Contact Retention

CONTACT SIZE	RETENTION AXIAL LOAD +/-10 PERCENT		SEPARATION FORCE MINIMUM (INITIAL)	
	NEWTONS	LBS.	NEWTONS	OUNCES
20	88.9	20	0.194	0.7
16	111.2	25	0.556	2
12	133.4	30	0.834	3

Wire Sealing Range

CONTACT SIZE	WIRE SEALING RANGE MIN.		WIRE SEALING RANGE MAX.	
	IN	MM	IN	MM
20	0.040	1.02	0.083	2.11
16	0.053	1.35	0.103	2.62
12	0.097	2.46	0.158	4.01
8	0.164	4.17	0.255	6.48
4	0.288	7.32	0.370	9.40
0	0.415	10.54	0.550	13.97

HOW TO ORDER 83723/DL SERIES CONNECTORS - MILITARY



(Military part number example)

STEP 1: SELECT SHELL STYLE, PLUG OR RECEPTACLE

RECEPTACLES ← Mates with → PLUGS

↓	↓	↓	↓
			
M83723/71 with Socket contacts	M83723/73 with Socket contacts	M83723/75 with Socket contacts	M83723/77 with Socket contacts
M83723/72 with Pin contacts Square Flange Receptacle	M83723/74 with Pin contacts Jam Nut Receptacle	M83723/76 with Pin contacts Standard Plug	M83723/78 with Pin contacts Shielded Plug

MATING GUIDE

	/71	/72	/73	/74	/75	/76	/77	/78
/71						*		*
/72					*		*	
/73						*		*
/74					*		*	
/75		*		*				
/76	*		*					
/77		*		*				
/78	*		*					

Mating connectors will mate a plug to a receptacle, so long as the layout and keying are the same and the contact types are opposite.

STEP 2: SELECT FINISH



- A*** = Aluminium Shell, black non-conductive anodized plated
- R** = Aluminium Shell, electroless nickel plated
- W** = Aluminium Shell, olive drab cadmium plated

*not available for styles /77 and /78

STEP 3: SELECT LAYOUT

⇒ See page 96-97 for listing by # of contacts

LAYOUT NUMBER	SERVICE RATING	CONTACTS			
		TOTAL NUMBER	20	16	12
0803	I	3	3		
0898	I	3	3		
1002	I	2	2		
1005	I	5	5		
1006	I	6	6		
1020	I	2		2	
1203	I	3		3	
1212	I	12	12		
1404	I	4			4
1407	I	7		7	
1412	I	12	9	3	
1415	I	15	15		
1610	I	10		10	
1624	I	24	24		
1808	I	8			8
1814	I	14		14	
1831	I	31	31		
2016	I	16		16	
2025	I	25	19		6
2028	I	28	24		4
2039	I	39	37	2	
2041	I	41	41		
2212	I	12			12
2219	I	19		19	
2232	I	32	26		6
2255	I	55	55		
2419	I	19			19
2443	I	43	23	20	
2457	I	57	55		2
2461	I	61	61		

STEP 4: SELECT POLARIZATION

- N = Normal
- 6 = Keyed Shell
- 7 = Keyed Shell
- 8 = Keyed Shell
- 9 = Keyed Shell
- Y** = Keyed Shell

- N = Normal Rotation
- 1 = Insert Rotation ***
- 2 = Insert Rotation ***
- 3 = Insert Rotation ***
- 4 = Insert Rotation ***
- 5 = Insert Rotation ***

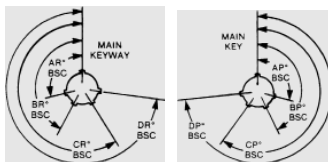

Receptacles

Plug

ALTERNATE KEYING POSITIONS OF SHELL					
SHELL SIZE	POLARIZING POSITION	KEYWAY ANGLE (DEGREES)			
		A	B	C	D
8 thru 24	N	105	140	215	265
	6	102	132	248	320
8 & 10	7	80	118	230	312
	8	35	140	205	275
10 only	9	64	155	234	304
	Y**	25	115	220	270
12 thru 28	6	18	149	192	259
	7	92	152	222	342
	8	84	152	204	334
	9	24	135	199	240
	Y**	98	152	268	338

** Position Y supersedes inactive positions 10 & Z designations. Ref MIL-STD-1554

ALTERNATE ROTATIONS OF LAYOUTS ***		
SHELL SIZE	POLARIZING POSITION	INSERT ANGLE (DEGREE)
8 & 10	N	0
	1	10
	2	20
	3	30
	4	40
12 thru 28	5	50
	N	0
	1	10
	2	20
	3	30
	4	40
	5	50

*** Positions 1-5 are inactive for new designs per MIL-STD-1554.

STEP 5: SELECT MODIFIER

-LC = for use with standard contacts, but supplied without contacts, seal plugs or tools (PO must state Less Contacts)

Note: -LC is not marked on part

HOW TO ORDER 83723/DL SERIES CONNECTORS - COMMERCIAL

1	2	3	4	5	6
DL66R	12-10	P	N	-6117	-LC
SHELL STYLE	LAYOUT	CONTACT	POLARIZATION	FINISH	MODIFIER

(Commercial part number example)

STEP 1: SELECT SHELL STYLE, PLUG OR RECEPTACLE

RECEPTACLES

Mates with

PLUGS



DL60R
Square Flange Receptacle



DL64R
Jam Nut Receptacle



DL66R
Standard Plug



DL68G
Shielded Plug

STEP 2: SELECT LAYOUT

⇒ See page 96-97 for listing by # of contacts

LAYOUT NUMBER	SERVICE RATING	CONTACTS			
		TOTAL NUMBER	20	16	12
8-3	I	3	3		
8-98	I	3	3		
10-2	I	2	2		
10-5	I	5	5		
10-6	I	6	6		
10-20	I	2		2	
12-3	I	3		3	
12-12	I	12	12		
14-4	I	4			4
14-7	I	7		7	
14-12	I	12	9	3	
14-15	I	15	15		
16-10	I	10		10	
16-24	I	24	24		
18-08	I	8			8
18-14	I	14		14	
18-31	I	31	31		
20-16	I	16		16	
20-25	I	25	19		6
20-28	I	28	24		4
20-39	I	39	37	2	
20-41	I	41	41		
22-12	I	12			12
22-19	I	19		19	
22-21	I	21		21	
22-32	I	32	26		6
22-55	I	55	55		
24-19	I	19			19
24-43	I	43	23	20	
24-57	I	57	55		2
24-61	I	61	61		

STEP 3: SELECT CONTACT



P = Pin **S** = Socket

STEP 4: SELECT POLARIZATION



- N** = Normal
- 6** = Keyed Shell
- 7** = Keyed Shell
- 8** = Keyed Shell
- 9** = Keyed Shell
- Y**** = Keyed Shell

ALTERNATE KEYING POSITIONS OF SHELL					
SHELL SIZE	POLARIZING POSITION	KEYWAY ANGLE (DEGREES)			
		A	B	C	D
8 thru 24	N	105	140	215	265
8 & 10	6	102	132	248	320
	7	80	118	230	312
	8	35	140	205	275
	9	64	155	234	304
10 only	Y**	25	115	220	270
12 thru 28	6	18	149	192	259
	7	92	152	222	342
	8	84	152	204	334
	9	24	135	199	240
	Y**	98	152	268	338

** Position Y supersedes inactive positions 10 & Z designations. Ref MIL-STD-1554

STEP 5: SELECT FINISH



- 6116*** = Aluminium Shell, black non-conductive anodized plated
- 6117** = Aluminium Shell, olive drab cadmium plated
- 6106** = Aluminium Shell, electroless nickel plated

*Not available for shell type DL68G

STEP 6: SELECT MODIFIER



-LC = for use with standard contacts, but supplied without contacts, seal plugs or tools (PO must state Less Contacts)

Note: -LC is not marked on part

LAYOUTS BY SHELL SIZE

○=20 ●=16 ◐=12

LAYOUT	8-3	8-98	10-2	10-5	10-6
# OF CONTACTS	3-#20	3-#20	2-#20	5-#20	6-#20
SERVICE RATING	I	I	I	I	I
LAYOUT	10-20	12-3	12-12	14-4	14-7
# OF CONTACTS	2-#16	3-#16	12-#20	4-#12	7-#16
SERVICE RATING	I	I	I	I	I
LAYOUT	14-12	14-15	16-10	16-24	18-08
# OF CONTACTS	9-#20, 3-#16	15-#20	10-#16	24-#20	8-#12
SERVICE RATING	I	I	I	I	I
LAYOUT	18-14	18-31	20-16	20-25	20-28
# OF CONTACTS	14-#16	31-#20	16-#16	19-#20, 6-#12	24-#20, 4-#12
SERVICE RATING	I	I	I	I	I

LAYOUTS BY SHELL SIZE

○=20 ●=16 ◐=12

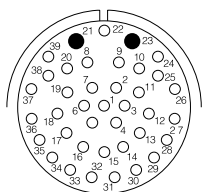

20-39

37-#20, 2-#16

LAYOUT

OF CONTACTS

SERVICE RATING

|

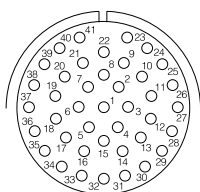

20-41

41-#20

|

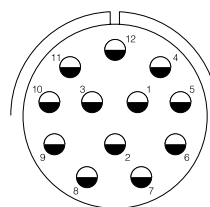

22-12

12-#12

|

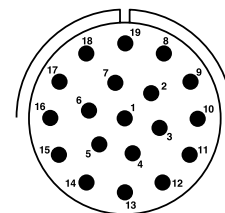

22-19

19-#16

|

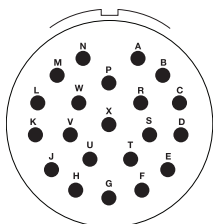

22-21

21-#16

LAYOUT

OF CONTACTS

SERVICE RATING

|

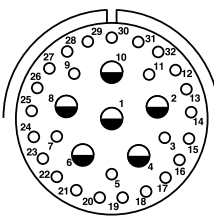

22-32

26-#20, 6-#12W

|

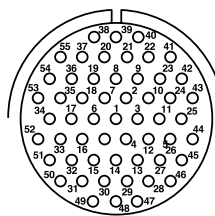

22-55

55-#20

|

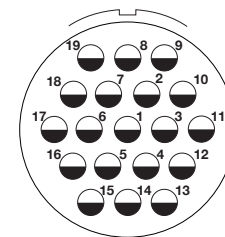

24-19

19-#12

|

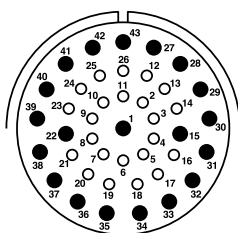

24-43

23-#20, 20-#16

LAYOUT

OF CONTACTS

SERVICE RATING

|

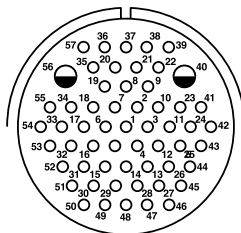

24-57

55-#20, 2-#12

|

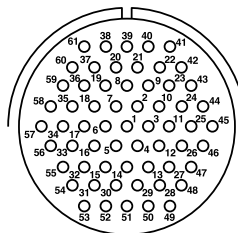

24-61

61-#20

|

CONTACTS

PINS

CONTACT SIZE	WIRE CRIMP SIZE RANGE	PIN PART NUMBER	COLOR BANDS			WIRE STRIP LENGTHS		WIRE INSULATION SEALING RANGE		WIRE HOLE FILLER	WIRE HOLE FILLER COLOR
			1	2	3	IN	MM	IN	MM		
20	20,22,24	M39029/5-115	Brown	Brown	Green	0.1875	4.77	.040/.083	1.02/2.11	MS27488-20-2	Red
16	16,18,20	M39029/5-116	Brown	Brown	Blue	0.2812	7.14	.053/.103	1.35/2.62	MS27488-16-2	Blue
12	12 & 14	M39029/5-118	Brown	Brown	Grey	0.2812	7.14	.097/.158	2.46/4.01	MS27488-12-2	Yellow

Insert head first, trim excess



SOCKETS

CONTACT SIZE	WIRE CRIMP SIZE RANGE	SOCKET PART NUMBER	COLOR BANDS			WIRE STRIP LENGTHS		WIRE INSULATION SEALING RANGE		WIRE HOLE FILLER	WIRE HOLE FILLER COLOR
			1	2	3	IN	MM	IN	MM		
20	20,22,24	M39029/5-115	Brown	Brown	Green	0.1875	4.77	.040/.083	1.02/2.11	MS27488-20-2	Red
16	16,18,20	M39029/5-116	Brown	Brown	Blue	0.2812	7.14	.053/.103	1.35/2.62	MS27488-16-2	Blue
12	12 & 14	M39029/5-118	Brown	Brown	Grey	0.2812	7.14	.097/.158	2.46/4.01	MS27488-12-2	Yellow

Insert head first, trim excess



PINS

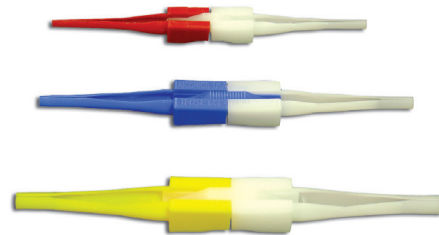
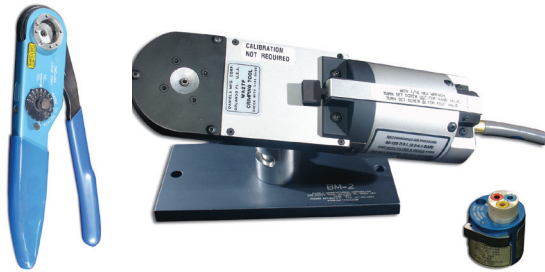

CONTACT SIZE	HAND-CRIMP TOOL	POWER-CRIMP TOOL	TURRET HEADS	USE LOCATOR COLOR	METAL		PLASTIC		
					INSERTION TOOL	EXTRACTION TOOL	INSERTION/EXTRACTION TOOL	INSERTION TIP COLOR	EXTRACTION TIP COLOR
20	M22520/1-01	WA27FH	M22520/1-02	Red	DAK83-20B	DRK83-20B	M81969/14-11	Red	White
16	M22520/1-01	WA27FH	M22520/1-02	Blue	DAK83-16B	DRK83-16B	M81969/14-03	Blue	White
12	M22520/1-01	WA27FH	M22520/1-02	Yellow	DAK83-12B	DRK83-12B	M81969/14-04	Yellow	White

SOCKETS

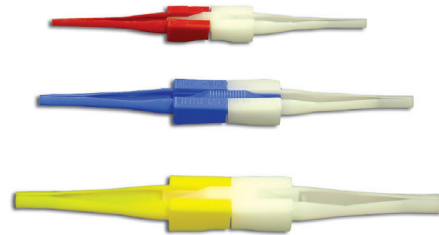
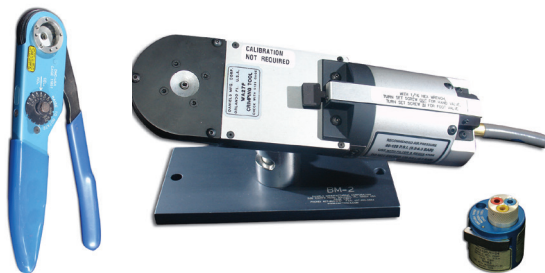

CONTACT SIZE	HAND-CRIMP TOOL	POWER-CRIMP TOOL	TURRET HEADS	USE LOCATOR COLOR	METAL		PLASTIC		
					INSERTION TOOL	EXTRACTION TOOL	INSERTION/EXTRACTION TOOL	INSERTION TIP COLOR	EXTRACTION TIP COLOR
20	M22520/1-01	WA27FH	M22520/1-02	Red	DAK83-20B	DRK83-20B	M81969/14-11	Red	White
16	M22520/1-01	WA27FH	M22520/1-02	Blue	DAK83-16B	DRK83-16B	M81969/14-03	Blue	White
12	M22520/1-01	WA27FH	M22520/1-02	Yellow	DAK83-12B	DRK83-12B	M81969/14-04	Yellow	White

DIMENSIONS

PLUG

M83723/75, /76, /77, /78
DL66R

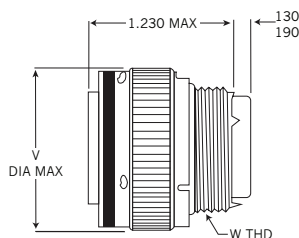

SHELL SIZE	V DIA. MAX.	W THREAD CLASS 2A
8	0.782 (19.86)	.5000-20 UNF
10	0.926 (23.52)	.6250-24 UNEF
12	1.043 (26.49)	.7500-20 UNEF
14	1.183 (30.04)	.8750-20 UNEF
16	1.305 (33.14)	1.000-20 UNEF
18	1.391 (35.33)	1.0625-18 UNEF
20	1.531 (38.88)	1.1875-18 UNEF
22	1.656 (42.06)	1.3125-18 UNEF
24	1.777 (45.13)	1.4375-18 UNEF

FLANGE MOUNT

M83723/71 & M83723/72
DL60R

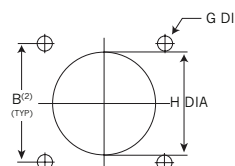
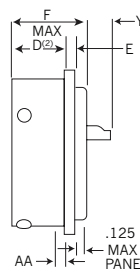
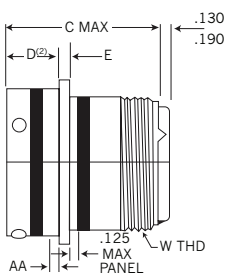
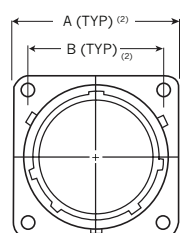

SHELL SIZE	AA MAX. PANEL THICKNESS		A MAX.	B +/- .005 (+/- 1.27)	C MAX.	D +/- .010 (+/- .254)	E +/- .016 (+/- .406)	W THREAD CLASS 2A	G +/- .005 (+/- .127)	H DIA. +/- .005 (+/- .127)
8	.087 (2.21)	.118 (3.00)	.828 (21.0)	.594 (15.1)	1.300 (33.02)	.781 (18.24)	.062 (1.6)	.5000-20 UNF	0.120 (3.05)	0.568 (14.42)
10	.087 (2.21)	.118 (3.00)	.954 (24.2)	.719 (18.3)	1.300 (33.02)	.781 (18.24)	.062 (1.6)	.6250-24 UNEF	0.120 (3.05)	0.685 (17.39)
12	.087 (2.21)	.118 (3.00)	1.047 (26.6)	.812 (20.6)	1.300 (33.02)	.781 (18.24)	.062 (1.6)	.7500-20 UNEF	0.120 (3.05)	0.864 (21.94)
14	.087 (2.21)	.118 (3.00)	1.141 (29.0)	.906 (23.0)	1.300 (33.02)	.781 (18.24)	.062 (1.6)	.8750-20 UNEF	0.120 (3.05)	0.989 (25.12)
16	.087 (2.21)	.118 (3.00)	1.234 (31.3)	.969 (24.6)	1.300 (33.02)	.781 (18.24)	.062 (1.6)	1.000-20 UNEF	0.120 (3.05)	1.113 (28.27)
18	.087 (2.21)	.118 (3.00)	1.328 (33.7)	1.062 (27.0)	1.300 (33.02)	.781 (18.24)	.062 (1.6)	1.0625-18 UNEF	0.120 (3.05)	1.238 (31.44)
20	.212 (5.38)	.212 (5.38)	1.453 (36.9)	1.156 (29.4)	1.300 (33.02)	.781 (18.24)	.094 (2.4)	1.1875-18 UNEF	0.120 (3.05)	1.363 (34.62)
22	.212 (5.38)	.212 (5.38)	1.578 (40.1)	1.250 (31.8)	1.300 (33.02)	.781 (18.24)	.094 (2.4)	1.3125-18 UNEF	0.120 (3.05)	1.488 (37.79)
24	.212 (5.38)	.212 (5.38)	1.703 (43.3)	1.375 (34.9)	1.300 (33.02)	.781 (18.24)	.094 (2.4)	1.4375-18 UNEF	0.147 (3.73)	1.615 (41.02)

All dimensions in inches (millimeters in parenthesis)

JAM NUT RECEPTACLE

M83723/73 & M83723/74
DL64R

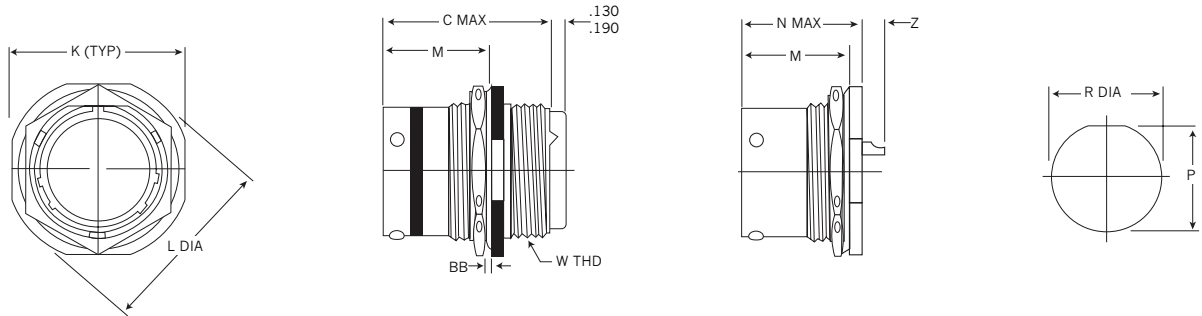

SHELL SIZE	BB MAX. PANEL	K MAX.	L +/- .016 (+/- .406)	M +/- .010 (+/- .254)	C MAX.	W THREAD CLASS 2A
8	.187 (4.75)	.979 (24.87)	1.063 (26.99)	.771 (19.58)	1.300 (33.02)	.5000-20 UNF
10	.187 (4.75)	1.104 (28.04)	1.188 (30.16)	.771 (19.58)	1.300 (33.02)	.6250-24 UNEF
12	.187 (4.75)	1.291 (32.79)	1.378 (34.94)	.771 (19.58)	1.300 (33.02)	.7500-20 UNEF
14	.187 (4.75)	1.391 (35.33)	1.501 (38.11)	.771 (19.58)	1.300 (33.02)	.8750-20 UNEF
16	.187 (4.75)	1.516 (38.51)	1.626 (41.29)	.771 (19.58)	1.300 (33.02)	1.000-20 UNEF
18	.187 (4.75)	1.641 (41.68)	1.751 (44.46)	.771 (19.58)	1.300 (33.02)	1.0625-18 UNEF
20	.250 (6.35)	1.766 (44.86)	1.939 (49.24)	.771 (19.58)	1.300 (33.02)	1.1875-18 UNEF
22	.250 (6.35)	1.954 (49.63)	2.063 (52.39)	.771 (19.58)	1.300 (33.02)	1.3125-18 UNEF
24	.219 (5.56)	2.079 (52.81)	2.188 (55.56)	.771 (19.58)	1.300 (33.02)	1.4375-18 UNEF

P	R DIA.
.605 (15.37)	.635 (16.13)
.730 (18.54)	.760 (19.30)
.917 (23.29)	.947 (24.05)
.980 (24.89)	1.010 (25.65)
1.105 (28.07)	1.135 (28.83)
1.229 (31.22)	1.260 (32.00)
1.354 (34.39)	1.385 (35.18)
1.479 (37.57)	1.510 (38.35)
1.604 (40.74)	1.635 (41.53)

All dimensions in inches (millimeters in parenthesis)

DUMMY RECEPTACLES, DUST CAPS & PLUG CAPS



SHELL SIZE	DUMMY RECEPTACLES OLIVE DRAB OVER CADMIUM PLATED	METAL DUSTCAP	
		FOR PLUGS	FOR RECEPTACLE FLANGED WITH SASH CHAIN
8	M83723/61-28*	M83723/59-28*	M83723/60-28*
10	M83723/61-210*	M83723/59-210*	M83723/60-210*
12	M83723/61-212*	M83723/59-212*	M83723/60-212*
14	M83723/61-214*	M83723/59-214*	M83723/60-214*
16	M83723/61-216*	M83723/59-216*	M83723/60-216*
18	M83723/61-218*	M83723/59-218*	M83723/60-218*
20	M83723/61-220*	M83723/59-220*	M83723/60-220*
22	M83723/61-222*	M83723/59-222*	M83723/60-222*
24	M83723/61-224*	M83723/59-224*	M83723/60-224*

*Select plating code to match connector plating

A = Black Anodized

R = Electroless nickel

W = Olive drab chromate over cadmium over electroless nickel (500-hour salt spray)

STANDARD CABLE CLAMPS

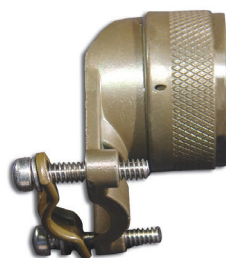

SHELL SIZE	STRAIGHT CLAMP		90°		CABLE ENTRY	
	LOW COST	SELF-LOCKING	LOW COST	SELF-LOCKING	MAX	MIN
8	M85049/52-1-8*	M85049/52S8*	M85049/51-1-8*	M85049/51S8*	.204 (5.18)	.125 (3.18)
10	M85049/52-1-10*	M85049/52S10*	M85049/51-1-10*	M85049/51S10*	.286 (7.26)	.187 (4.75)
12	M85049/52-1-12*	M85049/52S12*	M85049/51-1-12*	M85049/51S12*	.416 (10.57)	.291 (7.39)
14	M85049/52-1-14*	M85049/52S14*	M85049/51-1-14*	M85049/51S14*	.476 (12.09)	.351 (8.92)
16	M85049/52-1-16*	M85049/52S16*	M85049/51-1-16*	M85049/51S16*	.625 (15.88)	.501 (12.72)
18	M85049/52-1-18*	M85049/52S18*	M85049/51-1-18*	M85049/51S18*	.706 (17.93)	.518 (13.16)
20	M85049/52-1-20*	M85049/52S20*	M85049/51-1-20*	M85049/51S20*	.831 (21.11)	.581 (14.76)
22	M85049/52-1-22*	M85049/52S22*	M85049/51-1-22*	M85049/51S22*	.956 (24.28)	.644 (16.36)
24	M85049/52-1-24*	M85049/52S24*	M85049/51-1-24*	M85049/51S24*	1.081 (27.46)	.706 (17.93)

*Select plating code to match connector plating

A = Black Anodized

R = Electroless nickel

W = Olive drab chromate over cadmium over electroless nickel (500-hour salt spray)

All dimensions in inches (millimeters in parenthesis)

STANDARD CABLE CLAMPS

	DESCRIPTION	PART NUMBER PREFIX	STRAIGHT	90°	45°
	Heat Shrink Boot Adapter	M85049/60	X		
	Environmental	M85049/7			X
		M85049/9		X	
		M85049/11	X		
	EMI/RFI Non- Environmental	M85049/23			X
		M85049/24		X	
		M85049/25	X		
	EMI/RFI Environmental	M85049/6			X
		M85049/8		X	
		M85049/10	X		
	EMI/RFI Crimp Ring	M85049/26	X		
	EMI/RFI Banding	M85049/82	X		
		M85049/83			X
		M85049/84		X	
	Cable Tie	M85049/55		X	
		M85049/53	X		
		M85049/54			X
	Wire Seal Compression Nuts "E"	M85049/31	X		

NOTE: If military-standard versions won't work for your applications, please contact us with your requirements.

WIRE STRIPPING AND CONTACT CRIMPING

correct crimp



incorrect crimp



STEP 1: Strip wires. See above for correct strip length for contact. Insert wire into rear of contact. Wire insulation must push against rear of contact. Wire must be visible through inspection hole.

STEP 2: Use M22520/1-01 crimp tool with proper crimp locator M22520/1-02.

CONTACT SIZE	COLOR
20	Red
16	Blue
12	Yellow

STEP 3: Insert contact and wire into tool jaws. To crimp, squeeze handles together fully until ratchet releases and allows handles to expand; otherwise, contact cannot be extracted from tool jaws. Maintain slight insertion pressure on wire while crimping contact to wire.*

*IMPORTANT NOTE: Microsection the contact to verify crimp quality.

CONTACT INSERTION

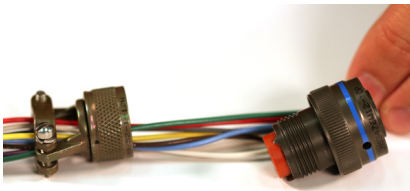

STEP 1: Remove backshell and put wired contacts through cable clamp opening.

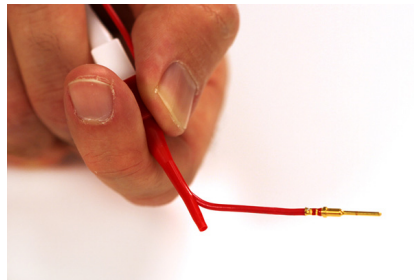

STEP 2: Use colored end of CIET tool for insertion. Place wire into tool at large opening. To facilitate contact insertion, a minimum six inches of free wire is recommended.

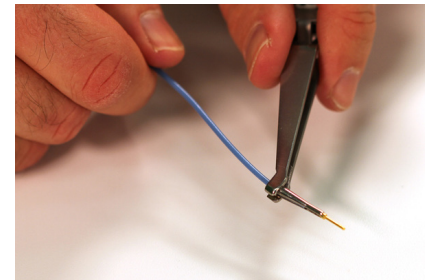

STEP 3: Slide tool on wire while holding thumb against wire at opening. Wire will slip into tool.

CONTACT INSERTION (CONT.)



STEP 4: With tool pressed against shoulder of contact, starting at the center cavity, insert wired contact and tool into properly-identified cavity at rear of plug with firm, even pressure. Do not use excessive pressure.

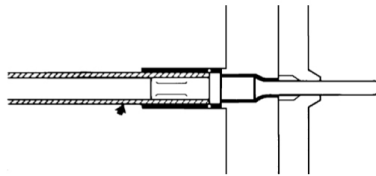

STEP 5: When contact bottoms, a slight click can be heard as tines of metal retaining clip snap into place behind contact shoulder.

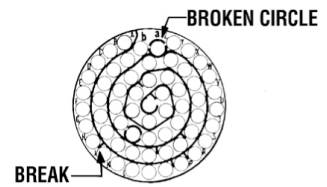

STEP 6: Check face of plug or receptacle for proper contact installation. In socket inserts with a large number of contacts, cavities are identified in a spiral pattern. A projecting line from the spiral indicates omission of a letter; a broken circle around a cavity indicates transition between capitals, lower case and double letters.



STEP 7: Withdraw tool from rear of plug. To be sure that contact is locked, pull back lightly on wire. Then remove tool from wire and proceed with other contacts.



STEP 8: After all contacts are inserted, fill unwired cavities with sealing plugs (insert head first and leave end protruding for ease of removal), assemble backshell on rear of connector.

CONTACT EXTRACTION

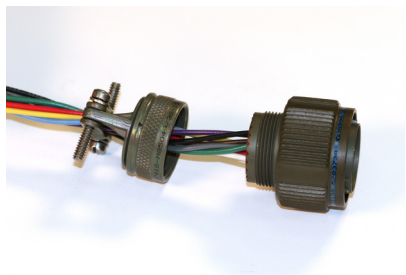

STEP 1: Remove hardware from plug or receptacle and slide hardware back along wire bundle.

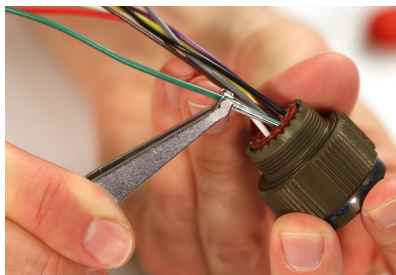

STEP 2: Using plastic or metal extraction tool with proper color code corresponding to contact size, place wire in tool.

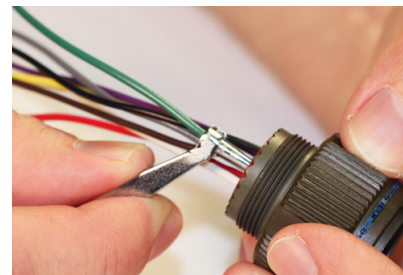

STEP 3: Insert tool into contact cavity until tool tip bottoms against the contact shoulder, expanding clip retaining tines.

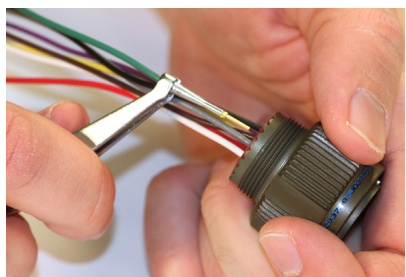

STEP 4: Hold wire firmly in tool and extract wired contact and tool. Repeat operation for all contacts to be extracted.

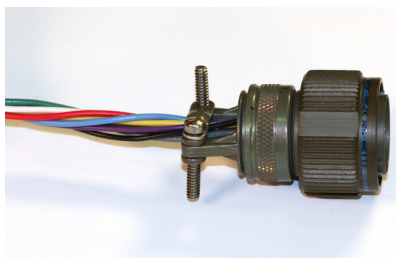

STEP 5: Fill any empty cavities with wire sealing plugs. Reassemble plug or receptacle hardware.

Note: DTS series shown.

TE Connectivity DEUTSCH 369 Series Connectors



HARSH ENVIRONMENT CONNECTORS PERFECT FOR AIRCRAFT CABIN SYSTEMS

TE DEUTSCH 369 series connectors offer high reliability in a compact, lightweight, fully sealed and cost-effective composite design. These harsh environment connectors are perfect for use in commercial aircraft cabin systems and other aerospace applications. Based on the popular TE DEUTSCH ARINC 809/EN4165 single module connector, 369 series connectors are available in 3, 6 and 9 contacts. AS39029 contacts can be easily extracted and reinserted using standard tooling and cable installation and maintenance is simple, with individually color-coded keying options. A scoop-proof design prevents damage and permits mating in low visibility conditions.

APPLICATIONS

- Aerospace cabin systems
- Automotive safety & security system connectors
- Traffic control equipment
- Marine industrial connectors
- Truck accessory disconnects
- Mining ventilation systems
- Car interconnections
- RV interconnections

FEATURES

- 3, 6 and 9 way configurations
- Based on existing ARINC 809 / EN4165
- Low smoke composite materials
- Robust design
- Mounting of in-line with cable-tie
- Button latching mechanism
- Color-coded keyed shells
- Scoop-proof interface
- Military standard AS39029 contacts
- Latch security feature
- Fully sealed

MATERIALS AND FINISHES

Shells, Insulators and backshells	High performance thermoplastic
Contacts	Copper alloy, gold plated
Seals	Fluorosilicone rubber

Designed to meet the requirements of RoHS

ELECTRICAL DATA

Dielectric withstanding voltage	1300 Vrms mated, <2 mA leakage
Operating current	5 A (size 22)

MECHANICAL DATA

Operating temperature	-55°C to +175°C (-67°F to +347°F)
Fluid resistance	I.A.W. EN2591-315
Sealing	12.1 kPa (1.75 psi) [15 km/(50,000 ft) altitude] / IP67
Vibration	EN2591-403, Method B, Level E, 8h/axis
Smoke & Toxicity	I.A.W. FAR 25.853, Appendix F
Flammability	I.A.W. FAR25.853 Appendix F; EN2591-317
Durability	500 mating cycles
Shock	EN2591-402, Method A, severity 100
Sealing Range size 22	.071 to 1.37mm (.028 to .054")

TE DEUTSCH 369 SERIES SELECT PART NUMBER

	1	2	3	4	5
D369-	P	33	-N	P	1
SERIES PREFIX	SHELL STYLE	LAYOUT	KEYING	CONTACT TYPE	CONTACTS SUPPLIED

STEP 1: SELECT SHELL STYLE



STEP 2: SELECT LAYOUT

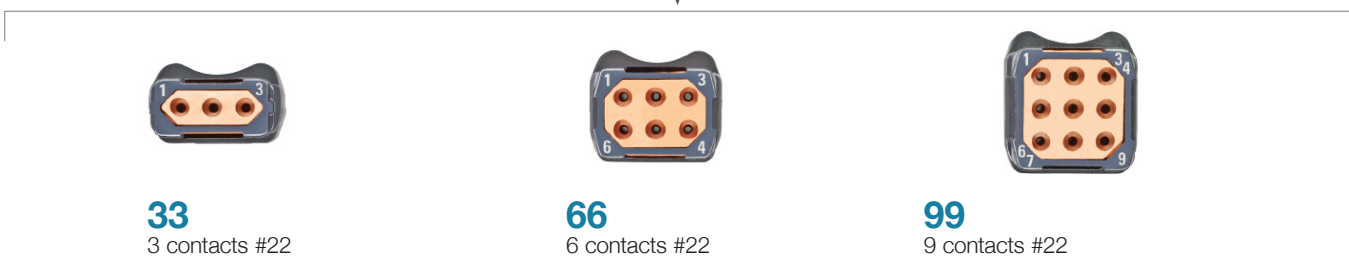

NOTE: View of termination side

STEP 3: SELECT KEYING



NOTE: Connectors are physically keyed and color coded. View on front of receptacle with female insert

STEP 4: SELECT CONTACT TYPE



STEP 5: SELECT CONTACT SUPPLIED



TE DEUTSCH 369 SERIES SELECT BACC PART NUMBER

	1	2	3	4
BACC65	CP	1	P	N
SERIES PREFIX	SHELL STYLE	LAYOUT	KEYING	CONTACT TYPE

STEP 1: SELECT SHELL STYLE



STEP 2: SELECT LAYOUT

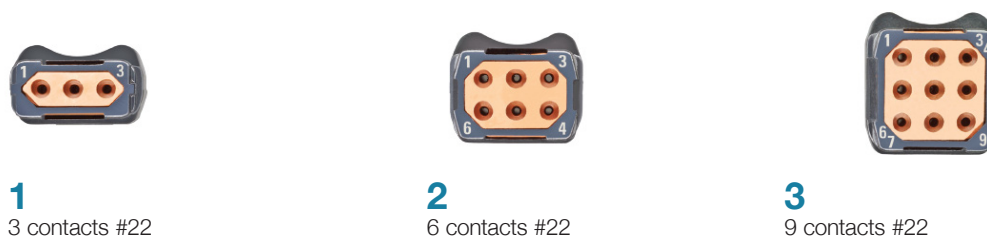

NOTE: View of termination side

STEP 3: SELECT KEYING



NOTE: Connectors are physically keyed and color coded. View on front of receptacle with female insert

STEP 4: SELECT CONTACT TYPE

P = Pin **S** = Socket

NOTE: Contacts are purchased separately
Pin - BACC47GC type

PINS

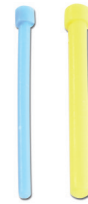
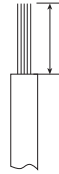

Insert head first, trim excess

CONTACT SIZE	WIRE SIZE AWG	PIN PART NUMBER	COLOR BANDS			WIRE STRIP LENGTHS	WIRE INSULATION		WIRE HOLE FILLER	COLOR
			1	2	3		MIN.	MAX.		
22	22,24,26 & 28	M39029/58-360	Orange	Blue	Black	.125 (3.18)	.028 (0.71)	.054 (1.37)	MS27488-22-2	Black

All dimensions in inches (millimeters in parenthesis)

SOCKETS

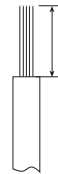

Insert head first, trim excess

CONTACT SIZE	WIRE SIZE AWG	SOCKET CONTACT PART NUMBER	COLOR BANDS			WIRE STRIP LENGTHS	WIRE RANGE		WIRE HOLE FILLER	COLOR
			1	2	3		MIN.	MAX.		
22	22,24,26 & 28	M39029/57-354	Orange	Yellow	Gray	.125 (3.18)	.028 (0.71)	.054 (1.37)	MS27488-22-2	Black

All dimensions in inches (millimeters in parenthesis)

CONTACT TOOLS

PINS



CONTACT SIZE	HAND-CRIMP TOOL	POWER- CRIMP TOOL	TURRET HEADS	USE LOCATOR COLOR	PLASTIC INSERTION/ EXTRACTION TOOL	INSERTION TIP COLOR	EXTRACTION TIP COLOR
22	M22520/2-01	WA22††	M22520/2-09	-	M81969/14-01	Green	White

†† Contact us for more tool accessories.
All dimensions in inches (millimeters in parenthesis)

SOCKETS



CONTACT SIZE	HAND-CRIMP TOOL	POWER- CRIMP TOOL	TURRET HEADS	USE LOCATOR COLOR	PLASTIC INSERTION/ EXTRACTION TOOL	INSERTION TIP COLOR	EXTRACTION TIP COLOR
22	M22520/2-01	WA22††	M22520/2-08	-	M81969/14-01	Green	White

†† Contact us for more tool accessories.
All dimensions in inches (millimeters in parenthesis)

PLUG

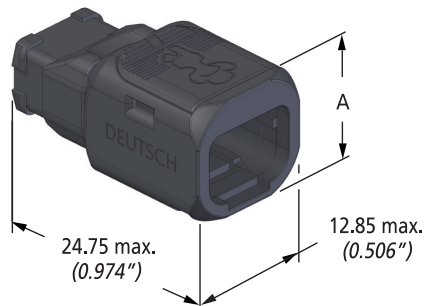

SHELL SIZE	A MAX.	MASS*
3	10.41 mm (0.410")	1.90 g
6	12.95 mm (0.510")	2.40 g
9	15.49 mm (0.610")	3.00 g

*Mass based on plug less male contact configuration
 Mass for 1 male contact = 0.073 g

IN-LINE RECEPTACLE

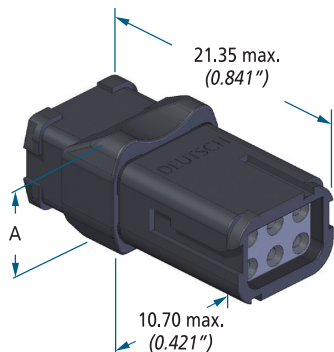

SHELL SIZE	A MAX.	MASS*
3	6.52 mm (0.257")	1.00 g
6	9.06 mm (0.357")	1.50 g
9	11.60 mm (0.457")	2.00 g

*Mass based on receptacle less female contact configuration
 Mass for 1 female contact = 0.112 g

STRAIGHT FOR CABLE TIE BACKSHELL

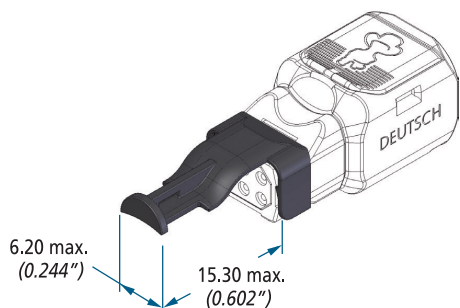

SHELL SIZE	PART NUMBER	MASS
3	D369-STB-3	0.24 g
6	D369-STB-6	0.25 g
9	D369-STB-9	0.28 g

Recommended cable-tie: 2.5 mm (0.10")

STRAIGHT BACKSHELLS FOR CABLE TIE

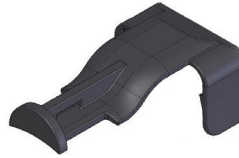

SHELL SIZE	STRAIGHT BACKSHELL
Size 3	D369-STB-3
Size 6	D369-STB-6
Size 9	D369-STB-9

ASSEMBLY

WIRE STRIPPING

Strip insulation from end of wire to be crimped. (See table for proper stripping dimensions.) Do not cut or damage wire strands.

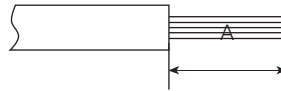

WIRE SIZE	A
22	.125 (3.18)

All dimensions in inches
(millimeters in parenthesis)

CONTACT CRIMPING

correct crimp



incorrect crimp



STEP 1: Strip wires. See above for correct strip length for contact. Insert wire into rear of contact. Wire insulation must push against rear of contact. Wire must be visible through inspection hole.

STEP 2: M22520 series crimp tool and locator is recommended. → See page 112 for choice of turret head and selection setting according to correct size, part number and wire gauge size.

STEP 3: Insert contact and wire into tool jaws. To crimp, squeeze handles together fully until ratchet releases and allows handles to expand; otherwise, contact cannot be extracted from tool jaws. Maintain slight insertion pressure on wire while crimping contact to wire.

CONTACT INSERTION

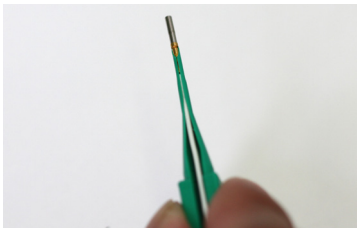

STEP 1: Using proper plastic insertion tool for corresponding contact, position wire in tip of the tool so that the tool tip presses against the contact shoulder. Use lubrication, Isopropyl Alcohol to aid with contact insertion/extraction.

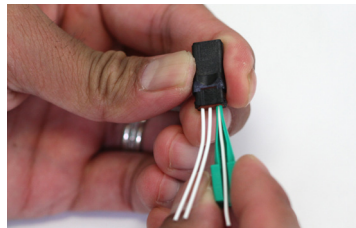

STEP 2: Press tool against contact shoulder and, with firm and even pressure, insert wired contact and tool tip into center contact cavity.

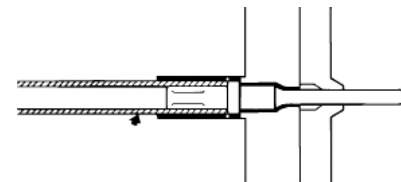

STEP 3: When contact bottoms, a slight "click" can be heard as tines of retaining clip snap into place behind contact shoulder. Do not rotate insertion/extraction tool in the connector. It can cause damage to the retention tines.

CONTACT INSERTION (CONT.)

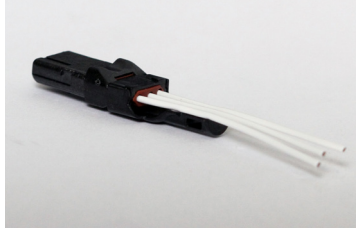

STEP 4 : Remove tool and pull back lightly on wire to make sure contact is properly seated. Repeat operation with remainder of contacts to be inserted.

STEP 5 : After all contacts are inserted, fill any empty cavities with wire sealing plugs.

CONTACT EXTRACTION

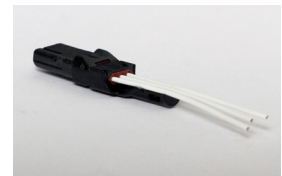
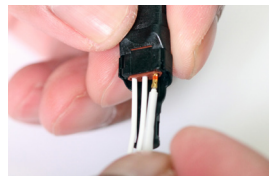
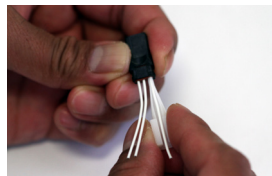
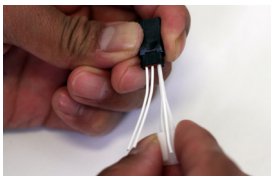

STEP 1: Using plastic extraction tool with proper color code corresponding to contact size, place wire in tool.

STEP 2: Insert tool into contact cavity until tool tip bottoms against the contact shoulder, expanding clip retaining tines.

STEP 3: Hold wire firmly in tool and extract wired contact and tool. Repeat operation for all contacts to be extracted.

STEP 4: Fill any empty cavities with wire sealing plugs. Reassemble plug or receptacle hardware.

BACKSHELL ASSEMBLY

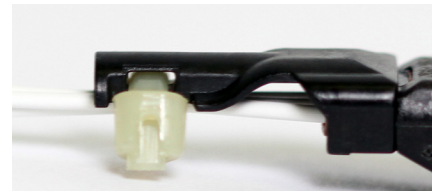
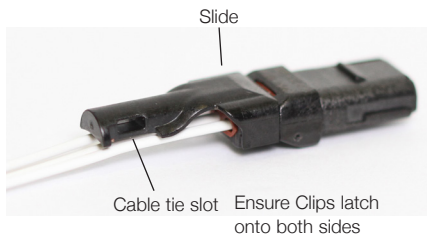

STEP 1: Backshell clips to the rear of the connector, fitting from either the top of the underside of the connector. Slide into position ensuring the side clips have latched into position.

STEP 2: Bundle the wires together under the backshell, ensuring the wires remain as straight as possible where they enter the wire seal. Secure wires with cable tie <math>< .10'' (2.5\text{mm})\text{ width x } .04'' (1.05)\text{ thick}</math> through the cable tie slot.

CONNECTOR MOUNTING

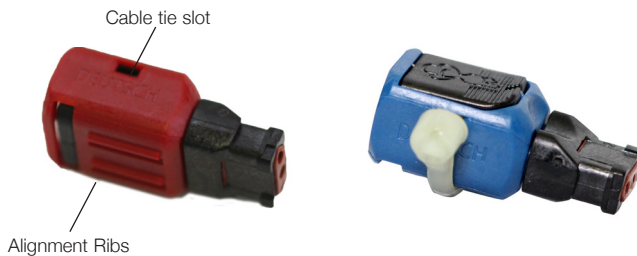

OPTION 1: Can mount connectors using cable tie <math>< .10'' (2.5\text{mm})\text{ width x } .04'' (1.05)\text{ thick}</math> through the connector cable tie slot.

OPTION 2: Connectors can be nested with adjacent 369 connectors. Pass one cable tie through both connectors to secure.

BACC CROSS REFERENCE

BACC P/N X-REF (LESS CONTACTS)	TE DEUTSCH PART NUMBER (LESS CONTACTS)
BACC65CP1SN	D369-P33-NS0
BACC65CP1PN	D369-P33-NP0
BACC65CR1PN	D369-R33-NP0
BACC65CR1SN	D369-R33-NS0
BACC65CP2SN	D369-P66-NS0
BACC65CP2PN	D369-P66-NP0
BACC65CR2PN	D369-R66-NP0
BACC65CR2SN	D369-R66-NS0
BACC65CP3SN	D369-P99-NS0
BACC65CP3PN	D369-P99-NP0
BACC65CR3PN	D369-R99-NP0
BACC65CR3SN	D369-R99-NS0
BACC65CP1PA	D369-P33-AP0
BACC65CR1SA	D369-R33-AS0
BACC65CP2PA	D369-P66-AP0
BACC65CR2SA	D369-R66-AS0
BACC65CP3PA	D369-P99-AP0
BACC65CR3SA	D369-R99-AS0
BACC65CP1PB	D369-P33-BP0
BACC65CR1SB	D369-R33-BS0
BACC65CP2PB	D369-P66-BP0
BACC65CR2SB	D369-R66-BS0
BACC65CP3PB	D369-P99-BP0
BACC65CR3SB	D369-R99-BS0
BACC65CP1PC	D369-P33-CP0
BACC65CR1SC	D369-R33-CS0
BACC65CP2PC	D369-P66-CP0
BACC65CR2SC	D369-R66-CS0
BACC65CP3PC	D369-P99-CP0
BACC65CR3SC	D369-R99-CS0
BACC65CP1PD	D369-P33-DP0
BACC65CR1SD	D369-R33-DS0
BACC65CP2PD	D369-P66-DP0
BACC65CR2SD	D369-R66-DS0
BACC65CP3PD	D369-P99-DP0
BACC65CR3SD	D369-R99-DS0
CONTACTS	
BACC47GC1A	M39029/58-360 (Pin)

Socket not available as BACC callout from TE DEUTSCH.

TE Connectivity DEUTSCH

Single Module EN4165 Connectors



HIGH RELIABILITY FOR CABIN INTERCONNECTIONS

The DMC-M has set the modular connector standard in the Aerospace & Military industries since the 1980's, and is now standardized by European Specification EN4165.

The DMC-M Single Module has a rectangular design perfect for both new design customs and retrofit applications thanks to its wide range of contact arrangements from sizes 24 to 8. Each mated half of the DMC-M connector can contain both male and female configuration modules, which allows you to mix input and output with signal and power supply. With a large number of insert layout possibilities, there are also many different keying possibilities between plugs and receptacles and a real EMI protection following most stringent Aerospace and Military specifications. Compliance with the most demanding avionic specifications in terms of sealing, vibrations, fire, smoke and toxicity compliance or mechanical endurance increases the reliability of the cabin interconnections. Designed with a lightweight composite material and metal plating, the Single Module DMC-M is ideal for weight and mass saving.

APPLICATIONS

- Cabin and avionic systems
- High-performance military aircraft
- Commercial airlines
- Communications equipment
- Missiles
- Military
- Railway
- Medical

FEATURES

- Light weight composite
- Modularity
- Color and mechanical coded
- Push-pull coupling
- Aluminum cable contact compliant

MATERIALS AND FINISHES

Housing	Composite
Plating	Nickel
Inserts	Thermoplastic and FSR
Contacts	Copper alloy with gold on nickel plating

ELECTRICAL DATA

Insulation Resistance	≥ 5000 MΩ
Maximum Current	Size 22 - 5 A Size 20 - 7.5 A Size 16 - 13 A Size 12 - 23 A Size 8 - 46 A

EMI Shielding Performance

FREQUENCY (MHz)	ATTENUATION (dB)
100	50
200	45
300	45
400	40
800	35
1000	30

MECHANICAL DATA

Temperature Range	-55°C to +175°C
Vibrations	20 g
Shock	100g
Durability	500 mating cycles
Salt Spray	500 hours
Interfacial Sealing	1.1 x 10 ⁻² bar

MECHANICAL DATA (CONT.)

Weight

EXTENDER RECEPTACLE	SHORT RECEPTACLE	PLUG	BACKSHELL
7 gr	6 gr	9 gr	4 - 7 gr
0.015 lbs	0.013 lbs	0.020 lbs	0.009 - 0.015 lbs

Recommended Mounting
for Receptacle Screw Torque

0.5 ± 0.1 N.m or 4.4 ± 0.9 In.LbF
When using TE DEUTSCH integrated nut plate
Ref. 787-0016-00 (see Accessories).

EXPLODED VIEW

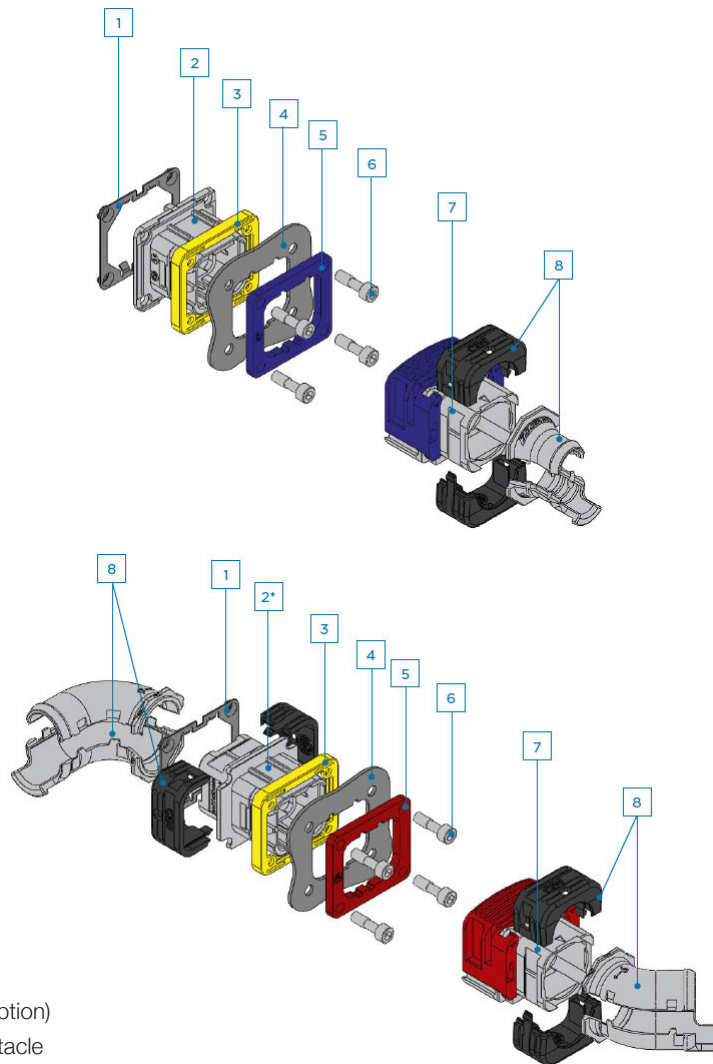

- 1 - Nut plate (option)
- 2 - Short receptacle
- 2* - Extender receptacle
- 3 - Sealing gasket (option)
- 4 - Panel (up to 2 mm thick)
- 5 - Color coding plate (option)
- 6 - Screws (ordered separately)
- 7 - Plug
- 8 - Backshell

HOW TO ORDER SINGLE MODULE EN4165 - COMMERCIAL

	1	2	3*	4*	5*
DMC-MD	24	D	-K	-S	-T
CONNECTOR TYPE	SHELL TYPE	SHELL KEYING	CODING PLATE	SEALING GASKET	NUT PLATE

*Note: Steps 3,4 and 5 are only for receptacles.

STEP 1: CHOOSE SHELL TYPE

20
Plug

24
Short Receptacle

26
Extender Receptacle

STEP 2: CHOOSE SHELL KEYING

N - A - B - C - D - E - F - G

STEP 3: CHOOSE CODING PLATE*

OMIT
Without

K
With

STEP 4: CHOOSE SEALING GASKET*

OMIT
Without

S
With

STEP 5: CHOOSE NUT PLATE*

OMIT
Without

T
With

Example: DMC-MD 24 A-K-S-T

	1	2	3	4	5	6*	7*	8*
EN4165	M	0	1	A	D	1	G	1
NUMBER OF THE BASIC STANDARD	FINISH	SHELL TYPE	SHELL TYPE	SERIES	SHELL KEYING	CODING PLATE	SEALING GASKET	NUT PLATE

Note: Steps 6, 7, and 8 are only for receptacles.

STEP 1: CHOOSE FINISH

M
Composite Nickel Plated

STEP 2: CHOOSE SHELL TYPE

6
Plug

0
Short Receptacle

7
Extender Receptacle

STEP 3: CHOOSE SHELL TYPE

1
Monomodule

STEP 4: CHOOSE SERIES

A
Series 2

STEP 5: CHOOSE SHELL KEYING

N - A - B - C - D - E - F - G

STEP 6: CHOOSE CODING PLATE*

0
Without

1
With

STEP 7: CHOOSE SEALING GASKET*

U
Without

G
With

STEP 8: CHOOSE NUT PLATE*

0
Without

1
With

HOW TO ORDER SINGLE MODULE EN4165 - ACCESSORIES (COMMERCIAL)

787	-8055	1 -20	2 M
CONNECTOR TYPE		ACCESSORIES TYPE	PLATING

STEP 1: CHOOSE ACCESSORIES TYPE

10 Straight Chimney	11 Clampshell	12 Straight Tie Wrap Ø 7mm	13 Straight Tie Wrap Ø 10mm
20 45° Indexable Chimney	21 45° Indexable Chimney Tie Wrap	30 90° Indexable Chimney	31 90° Indexable Chimney Tie Wrap

STEP 2: CHOOSE PLATING

M
Nickel

HOW TO ORDER SINGLE MODULE EN4165 - ACCESSORIES

EN4165	-026	1 M	2 20 A
NUMBER OF THE BASIC STANDARD	CHAPTER	FINISH	ACCESSORIES TYPE

STEP 1: CHOOSE FINISH

M
Composite Nickel Plated

STEP 2: CHOOSE ACCESSORIES TYPE

10 Straight Chimney	20 45° Indexable Chimney	30 90° Indexable Chimney
10 A Straight Tie Wrap Ø 10mm	20 A 45° Indexable Chimney Tie Wrap	30 A 90° Indexable Chimney Tie Wrap

BACKSHELLS & PLUGS

Backshells

Straight Clampshell
787-8055-11M
Screws Delivered

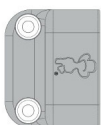

Straight Chimney
787-8055-10M
EN4165-026M10

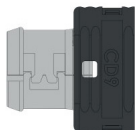

Straight Chimney
Tie Wrap Ø 7mm
787-8055-12M

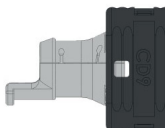

Straight Chimney
Tie Wrap Ø 10mm
787-8055-13M
EN4165-026M10A

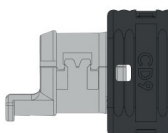

45° Indexable Chimney
787-8055-20M
EN4165-026M20

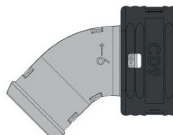

45° Indexable Chimney
Tie Wrap
787-8055-21M
EN4165-026M20A

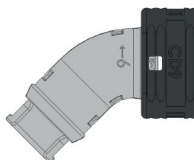

90° Indexable Chimney
787-8055-30M
EN4165-026M30

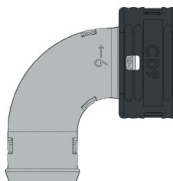

90° Indexable Chimney
Tie Wrap
787-8055-31M
EN4165-026M30A

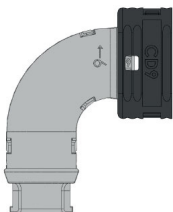

Mates with



Plugs

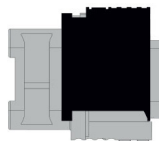

DMC-MD 20 N
BACC65BUMN
EN4165M61AN

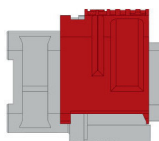

DMC-MD 20 A
BACC65BUMA
EN4165M61AA

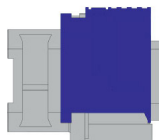

DMC-MD 20 B
BACC65BUMB
EN4165M61AB

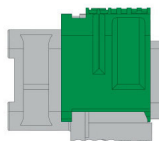

DMC-MD 20 C
BACC65BUMC
EN4165M61AC

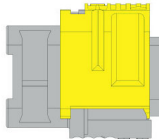

DMC-MD 20 D
BACC65BUMD
EN4165M61AD

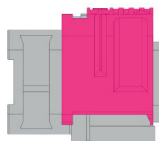

DMC-MD 20 E
EN4165M61AE

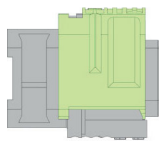

DMC-MD 20 F
EN4165M61AF

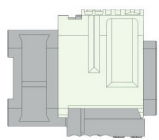

DMC-MD 20 G
EN4165M61AG

TE/DEUTSCH Part Numbers (DMC-M / 787)
BOEING Part Numbers (BACC)
STANDARD Part Numbers (EN4165)

BACKSHELLS & RECEPTACLES

RECEPTACLES

Extender Receptacle

DMC-MD 26 *X
 BACC65CAM*X
 EN4165M71A*X

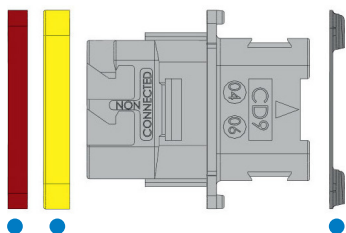

● = To be ordered separately (no BACC65 references)

SHELL KEYING

*X							
N	A	B	C	D	E	F	G

Short Receptacle

DMC-MD 24 *X
 BACC65BVM*X
 EN4165M01A*X

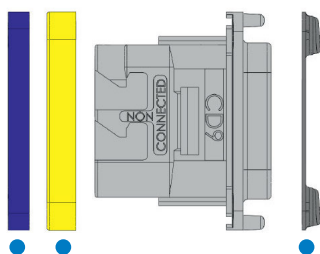

● = To be ordered separately (no BACC65 references)

NOTE: No accessory can be fixed on this receptacle.

Mates with
 ↔

BACKSHELLS

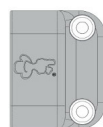

Straight Clampshell
 787-8055-11M
 Screws Delivered

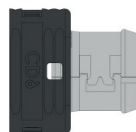

Straight Chimney
 787-8055-10M
 EN4165-026M10



Straight Chimney
 Tie Wrap Ø 7mm
 787-8055-12M

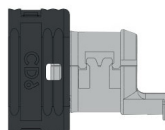

Straight Chimney
 Tie Wrap Ø 10mm
 787-8055-13M
 EN4165-026M10A

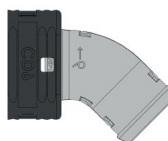

45° Indexable Chimney
 787-8055-20M
 EN4165-026M20

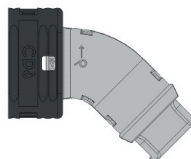

45° Indexable Chimney
 Tie Wrap
 787-8055-21M
 EN4165-026M20A

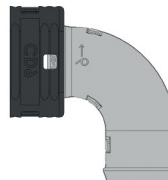

90° Indexable Chimney
 787-8055-30M
 EN4165-026M30

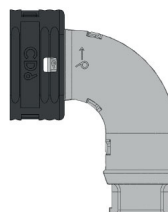



















90° Indexable Chimney
 Tie Wrap
 787-8055-31M
 EN4165-026M30A

TE/DEUTSCH Part Numbers (DMC-M / 787)
 BOEING Part Numbers (BACC)
 STANDARD Part Numbers (EN4165)

MODULES

PIN CONTACTS PER AS39029/58 AND EN3155



















MODULES	DETAILS	PART NUMBER CROSS
	20 contacts size 22	DMC-M 20-22 AN BAC10BC2022PNB EN4165A20-221NA
	20 contacts size 22	DMC-MA 20-22 AN EN4165A20A221NA
	12 contacts size 20	DMC-M 12-20 AN BAC10BC1220PNB EN4165A12-201NA
	8 contacts size 16	DMC-M 08-16 AN BAC10BC0816PNB EN4165A08-161NA
	4 contacts size 12	DMC-M 04-12 AN EN4165A04-121NA
	1 contact size 8	DMC-M 01-08 AN EN4165A01-081NA
	6 contacts size 16 2 contacts size 22 8 contacts size 24	DMC-M 16-02 AN 2226454-1
	6 contacts size 16 5 contacts size 22	DMC-M 99-01 AN BAC10BC1622PNB EN4165A99-011NA
	6 contacts size 16 5 contacts size 22	DMC-MA 99-01 AN EN4165A99A011NA
	8 contacts size 22 3 contacts size 20	DMC-M 99-02 AN
	8 contacts size 20 8 contacts size 24	DMC-M 99-03 AN
	6 contacts size 20 2 contacts size 22 8 contacts size 24	DMC-M 99-04 AN
	8 contacts size 22 2 contacts size 12	DMC-M 99-06 AN BAC10BC1001PNB
	8 contacts size 20 2 contacts size 16	DMC-M 99-10 AN EN4165A99-101NA
	6 optical contacts	DMC-M MC5 AN
	2 optical contacts 5 contacts size 16 2 contacts size 22	DMC-M T47 AN
	12 or 24 optical contacts for round or ribbon cable	Hermaphrodite DMC-M MC6
	Blanking module	DMC-M 00-00 PN EN4165-1N

Aluminum Cable Technology

High Speed Modules

Distribution Shunt Modules

SOCKET CONTACTS PER AS39029/57 AND EN3155

MODULES	DETAILS	PART NUMBER CROSS
	20 contacts size 22	DMC-M 20-22 BN BAC10BC2022SNB EN4165 20-22 A1NB
	20 contacts size 22	DMC-MA 20-22 BN EN4165A20A221NB
	12 contacts size 20	DMC-M 12-20 BN BAC10BC1220SNB EN4165A12-201NB
	8 contacts size 16	DMC-M 08-16 BN BAC10BC0816SNB EN4165A08-161NB
	4 contacts size 12	DMC-M 04-12 BN EN4165A04-121NB
	1 contact size 8	DMC-M 01-08 BN EN4165A01-081NB
	6 contacts size 16 2 contacts size 22 8 contacts size 24	DMC-M 16-02 BN 2226455-1
	6 contacts size 16 5 contacts size 22	DMC-M 99-01 BN BAC10BC1622SNB EN4165A99-011NB
	6 contacts size 16 5 contacts size 22	DMC-MA 99-01 BN EN4165A99A011NB
	8 contacts size 22 3 contacts size 20	DMC-M 99-02 BN
	8 contacts size 20 8 contacts size 24	DMC-M 99-03 BN
	6 contacts size 20 2 contacts size 22 8 contacts size 24	DMC-M 99-04 BN
	8 contacts size 22 2 contacts size 12	DMC-M 99-06 BN BAC10BC1001SNB
	8 contacts size 20 2 contacts size 16	DMC-M 99-10 BN EN4165A99-101NB
	6 optical contacts	DMC-M MC5 BN
	2 optical contacts 5 contacts size 16 2 contacts size 22	DMC-M T47 BN
	20 contacts size 22 5 shunts 4 ways	DMC-M 22-05 BN EN4165A20Y221NB
	20 contacts size 22 3 shunts 4 ways 4 shunts 2 ways	DMC-M 22-07 BN EN4165A2AY221NB
	20 contacts size 22 10 shunts 2 ways	DMC-M 22-10 BN EN4165A2BY221NB

Note: 1) DMC-M modules are compatible with Aluminum Cable contacts and with EN3155-70 / 71 size 22. 2) Distribution shunt modules use dedicated contacts based on standard M39029. 3) DMC-M 99-02, 99-03, 99-04, 16-02 are specific modules for high speed Ethernet application.

TE/DEUTSCH Part Numbers (DMC-M / 787)
BOEING Part Numbers (BAC10)
STANDARD Part Numbers (EN4165)

CONTACTS

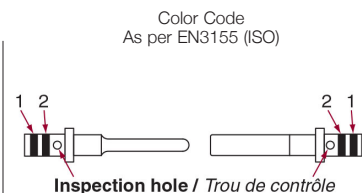
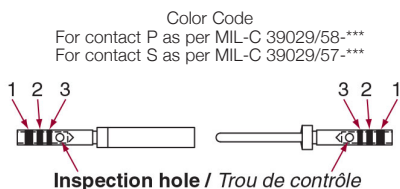

CONTACTS								CABLES	
PART NUMBER DEUTSCH	TYPE	SIZE	COLOR CODES AS PER MIL			COLOR CODES AS PER EN3155		Ø OVER INSULATION IN/MM (GAUGE AWG)	WIRE SECTION IN/ MM²
			1	2	3	1	2		
724-0001-22	P	22/22	Orange	Blue	Black	-	-	0.71 to 1.37 (22 - 26)	0.095 to 0.40
724-0003-22	S		Orange	Green	Yellow	-	-		
182-0860-22	P	22/20	-	-	-	Red	Green	0.71 to 1.37 (22 - 26)	0.095 to 0.40
182-0862-22	S		-	-	-				
724-0001-20	P	20/20	Orange	Blue	Orange	-	-	0.85 to 2.11 (20 - 24)	0.25 to 0.60
724-0003-20	S		Orange	Green	Violet	-	-		
724-1063-20	P	20/18	-	-	-	Red	Brown	(18 - 24)	0.25 to 1.00
724-1064-20	S		-	-	-				
724-0001-16	P	16/16	Orange	Blue	Yellow	-	-	1.20 to 2.77 (16 - 20)	0.60 to 1.20
724-0003-16	S		Orange	Green	Gray	-	-		
724-1063-16	P	16/14	-	-	-	Blue	White	(14 - 20)	0.60 to 2.00
724-1064-16	S		-	-	-				
724-0001-12	P	12/12	Orange	Blue	Green	-	-	1.90 to 3.61 (12 - 14)	2.00 to 3.00
724-0003-12	S		Orange	Green	White	-	-		
724-1063-12	P	12/10	-	-	-	Yellow	White	1.90 to 2.90 (14 - 10)	2.00 to 5.00
724-1064-12	S		-	-	-				
724-0001-08	P	Power 8	-	-	-	-	-	3.80 to 5.15 (8)	5.30 to 8.98
724-0003-08	S		-	-	-	-	-		
182-0001-08	P	Power 8	-	-	-	-	-	3.80 to 5.15 (8)	5.30 to 8.98
182-0003-08	S		-	-	-	-	-		
724-0004-16	P	Micro-Coax 16	Yellow	Red	Yellow	-	-	KX 22	0.057 to 0.158
724-0005-16	S		Yellow	Orange	Red	-	-		
182-0125-08	P	8	-	-	-	-	-	ALPEN A 26 DT	-
182-0126-08	S		-	-	-	-	-		
182-0048-08	P	8	-	-	-	-	-	Interface SMA	-
182-0044-08	S		-	-	-	-	-		
724-1272-22	S	Shunt 22	-	-	-	-	-	0.71 to 1.37 (22 - 26)	0.095 to 0.40

DATABUS CONTACTS

DATABUS CONTACTS (TWISTED PAIR) AS PER MIL-C 38999 SERIES I, III AND IV STANDARD						
CONTACTS				CABLES		
PART NUMBER	TYPE	SIZE	COLOR CODE	TYPES	CONDUCT. MAX. SECTION	BRAID Ø MAX.
182-0034-03	P	8	Brown-Red	Braid Simple	2 x 0.34 mm²	3.48
182-0035-03	S					
182-0034-04	P	8	Red-Red	High Immunity Double Braid	2 x 0.34 mm²	3.91
182-0035-04	S					

Part numbers in red - Standard contacts delivered with modules

Note: Contacts for aluminium cable, contact us.

CONTACTS AND TOOLING



CONTACTS	TOOLING				
	CRIMPING TOOL P/N DEUTSCH	CRIMPING TOOL P/N MIL	LOCATOR P/N DEUTSCH	LOCATOR P/N MIL	INSERTION AND EXTRACTION TOOL
724-0001-22	057-0463-12	M22520/2-01	057-0467-32	M22520/2-09	M81969/14-01
724-0003-22			057-0515-32	M22520/2-06	
182-0860-22	057-0463-12	M22520/2-01	057-0467-32	M22520/2-09	M81969/14-01
182-0862-22					
724-0001-20	057-0461-11	M22520/1-01	057-0466-21	M22520/1-04	M15570-20
724-0003-20					
724-1063-20	057-0461-11	M22520/1-01	056-0466-21	M22520/1-04	-
724-1064-20					
724-0001-16	057-0461-11	M22520/1-01	057-0466-21	M22520/1-04	M15570-16
724-0003-16					
724-1063-16	057-0461-11	M22520/1-01	056-0466-21	M22520/1-04	-
724-1064-16					
724-0001-12	057-0461-11	M22520/1-01	057-0466-21	M22520/1-04	M15570-12
724-0003-12					
724-1063-12	057-0461-11	-	056-0466-21	M22520/1-04	-
724-1064-12					
724-0001-08	057-0064-05 A	-	057-0065-05 A	-	114-008 or M81969/14-06
724-0003-08					
182-0001-08	057-0064-05 A	-	057-0065-05 A	-	114-008 or M81969/14-06
182-0003-08					
724-0004-16	057-0463-12*	-	057-0539-32*	-	M15570-16
724-0005-16	057-0509-14**		057-0511-34**		
182-0125-08	-	-	-	-	-
182-0126-08	-	-	-	-	-
182-0048-08	-	-	-	-	-
182-0044-08	-	-	-	-	-
724-1272-22	057-0463-12	M22520/2-01	057-0467-32	M22520/2-09	M81969/14-01

Part numbers in red - Standard contacts delivered with modules

*For central contact **For exterior contact

DATABUS CONTACTS

DATABUS CONTACTS (TWISTED PAIR) AS PER MIL-C 38999 SERIES I, III AND IV STANDARD			
SLEEVE TYPE	CRIMPING TOOL CENTRAL CONDUCTOR	CRIMPING TOOL FERRULE	INSERTION AND EXTRACTION TOOL
Thermoplastic and silicone	TDB-CY-08	TDB-CT-HEX Mark C	114-008 or M81969/14-06
Thermoplastic and silicone	TDB-CT-08	TDB-CT-HEX Mark D	114-008 or M81969/14-06

RECEPTACLES & PLUG

RECEPTACLE

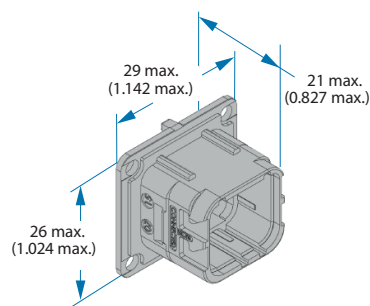

EXTENDER RECEPTACLE

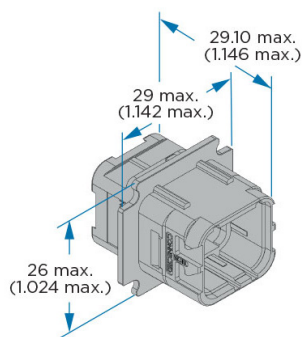

PLUG

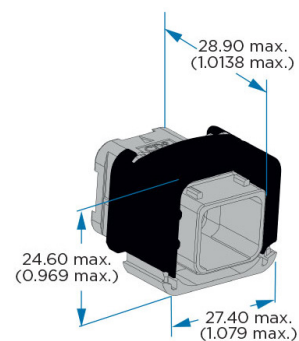

BACKSHELL / CHIMNEY INDEXATION

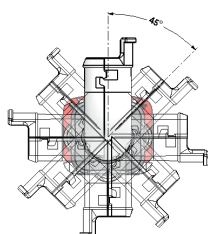

All backshells can be indexed in eight positions on the rear of plug and extender receptacle shell. This gives maximum flexibility during design and cable installation and reduces the number of variants and components.

MOUNTING PANEL DETAILS

BOX MOUNTING RECEPTACLE

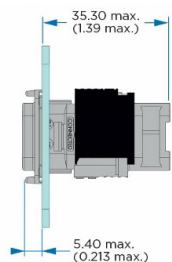

EXTENDER RECEPTACLE

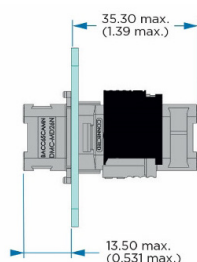

STRAIGHT CHIMNEY

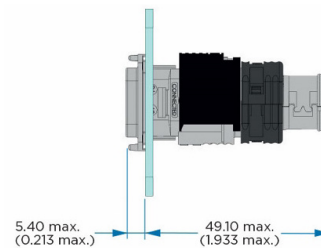

STRAIGHT CLAMPSHELL

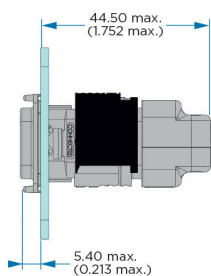

STRAIGHT CHIMNEY TIE WRAP

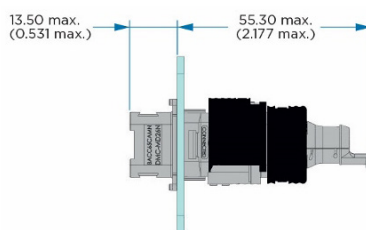

UNIVERSAL UNSHIELDED ACCESSORY

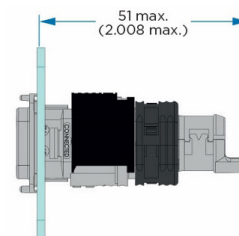

45° INDEXABLE CHIMNEY

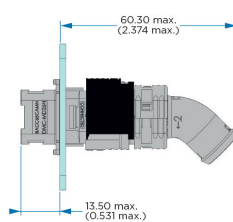

45° INDEXABLE CHIMNEY TIE WRAP

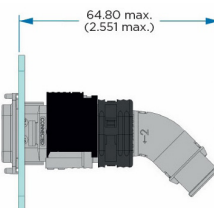

90° INDEXABLE CHIMNEY

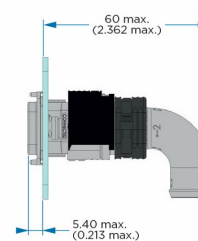

PANEL CUTOUT

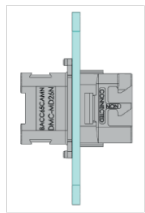

GENERIC DIMENSIONS

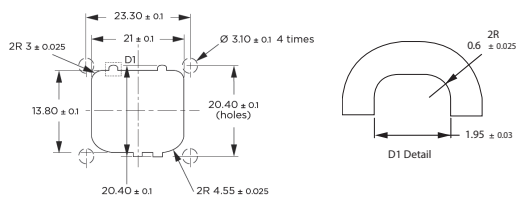

FREE

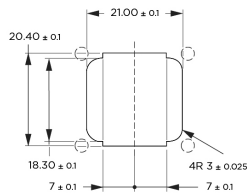

ORIENTATION

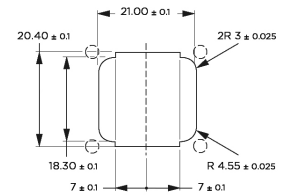

Note: Dimensions are in millimeters. Each hole Ø 3.1 mm must receive a screw (screw type 4-40) Recommended panel thickness: 0.8 mm min. - 2 mm max.

PANEL CODING KEYING

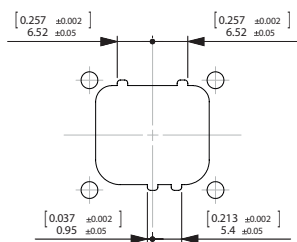

CODING N

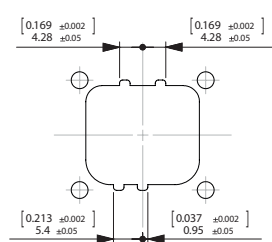

CODING A

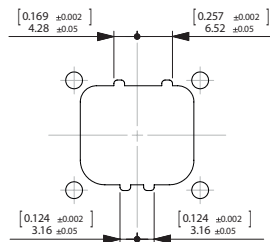

CODING B

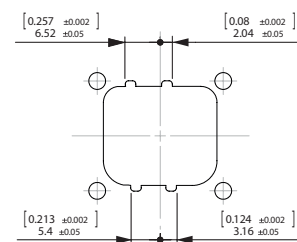

CODING C

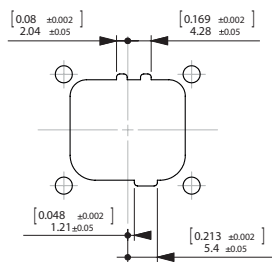

CODING D

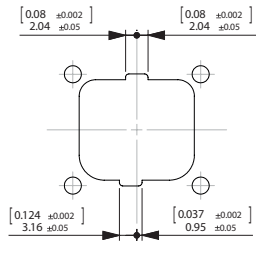

CODING E

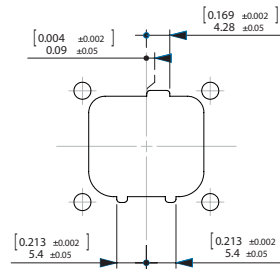

CODING F

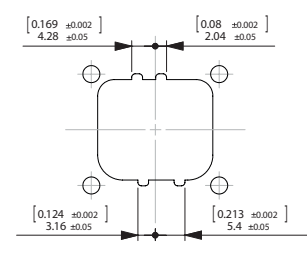

CODING G

PANEL MOUNTING BRACKET CUTOUT

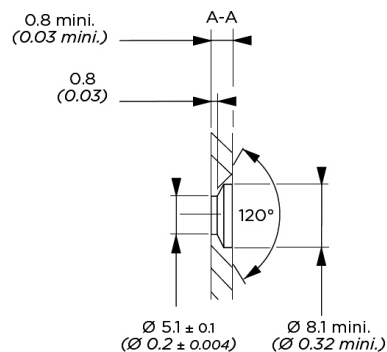
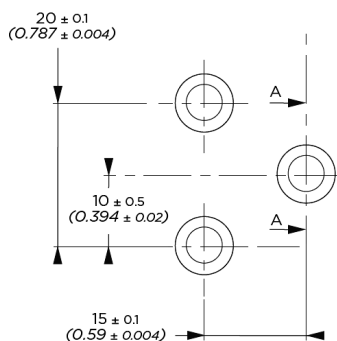

Overall dimensions and characteristics are given for indication guidance only. TE DEUTSCH reserves the right to modify them for production improvement reasons.

OPTIONAL PARTS FOR RECEPTACLE

KEYING PLATE

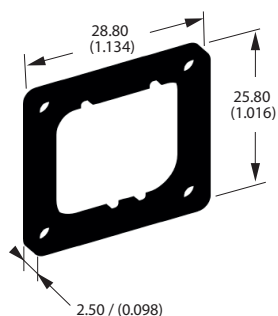

- | | |
|-----------------|-------------|
| N - 787-0015-00 | EN4165-25CN |
| A - 787-0015-01 | EN4165-25CA |
| B - 787-0015-02 | EN4165-25CB |
| C - 787-0015-03 | EN4165-25CC |
| D - 787-0015-04 | EN4165-25CD |
| E - 787-0015-05 | EN4165-25CE |
| F - 787-0015-06 | EN4165-25CF |
| G - 787-0015-07 | EN4165-25CG |

SEALING GASKET

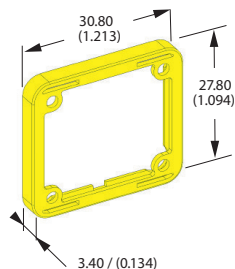

787-0011-00
EN4165-25E

NUT PLATE

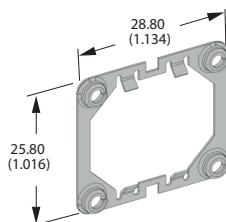

787-0016-00
EN4165-25D

PANEL MOUNTING BRACKET

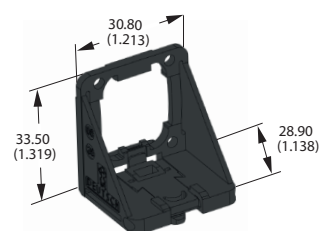

787-8014-00

PROTECTIVE CAPS

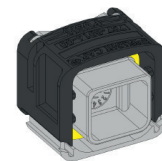
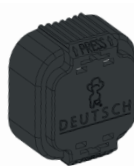

PROTECTION LEVEL	PLUG CAP	RECEPTACLE CAP	RECEPTACLE AND EXTENDER CAP	PLUG FLIGHT CAP	RECEPTACLE AND EXTENDER FLIGHT CAP
	104-0236-00	104-0235-00	WITH LANYARD 787-8011-00 WITHOUT LANYARD 787-8009-00	787-8010-00	WITH LANYARD 787-8017-00; EN4165M3C WITHOUT LANYARD 787-8016-00
Shipping	x	x	-	-	-
Dust	x	x	x	x	x
EMI	-	-	x	x	x
Low Pressure Sealing	-	-	-	x	x



Lanyard
787-8013-00

TE DEUTSCH Part Numbers (DMC-M / 787)

MOUNTING BRACKETS

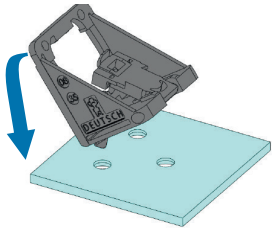

STEP 1: Locate mating parts

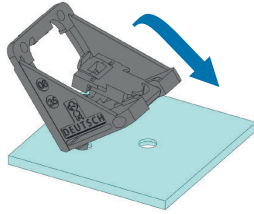

STEP 2: Install rear dowels

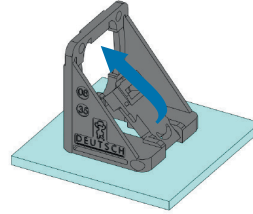

STEP 3: Fix and snap in position

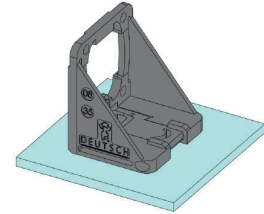

STEP 4: Installed.

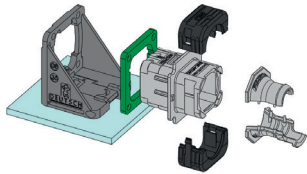

STEP 5: Align receptacle with bracket

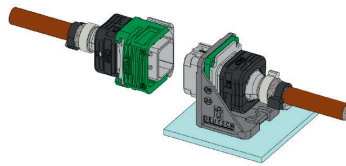

STEP 6: Install and fix in position

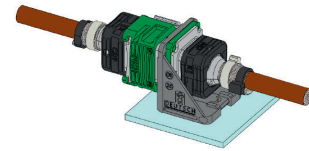

STEP 7: Assembled

CONTACT CRIMPING



STEP 1: Use a crimping tool with the appropriate locator.



STEP 2: Strip the insulation* 5 mm maximum.



STEP 3: Insert the contact in the crimping tool.



STEP 4: Insert the wire in the contact.



STEP 5: Tighten the crimping tool.



STEP 6: Inspect the contact. It must have 8 indents, and the wire must be seen in the contact inspection hole.

*For aluminum wire, contact us.

Note: For the use of a shielded version, do not forget to slide the cables in the chimney before crimping the contacts.

CONTACT INSERTION / EXTRACTION



STEP 1: Use the appropriate plastic tool. There is one tool for each contact size.

TOOLS PART NUMBERS	CONTACTS SIZE
M81969/14-01	22
M15570-20	20
M15570-16	16
M15570-12	12
114-008 or M81969/14-06	8

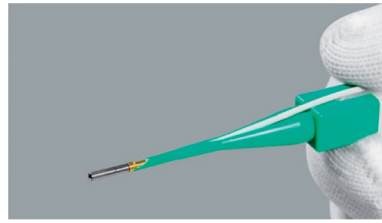

STEP 2: Insert the wire in the slot of the colored side of tool. Pull the wire until the contact butts against the tool.

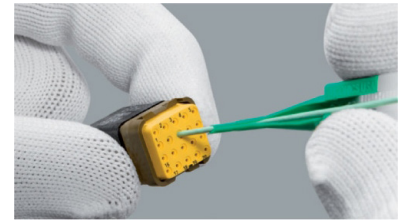

STEP 3: Insert the contact in the corresponding module cavity. Push the contact fully home. Then remove the tool and lightly pull the wire back to make sure that the contact is well inserted.



STEP 4: For extraction, insert the wire in the slot of the white side of the tool. Slide the tool into the cavity and push fully home until it is butted against the contact shoulder.

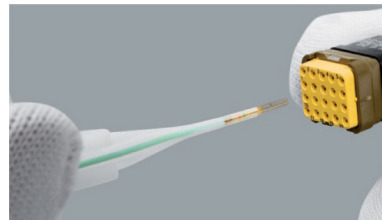

STEP 5: Press the wire between the fingers and the tool. Then pull the overall wire and tool back.

MODULE INSERTION / EXTRACTION (NOTE: 4-WAY MODULE SHOWN)

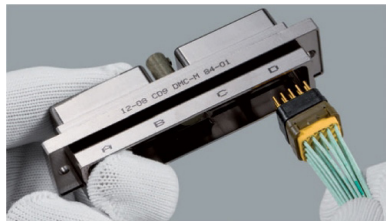

STEP 1: The module must be inserted from the rear side of the housing. The module polarization key must be visible from the marked side of the housing.



STEP 2: Push manually the module (wired or not) until butting. For sealed modules use the insertion tool part number 057-0699-00 A or B. Make sure that the module is well inserted either by pulling back the wires (if wired) or by pushing the module from the front of the housing.

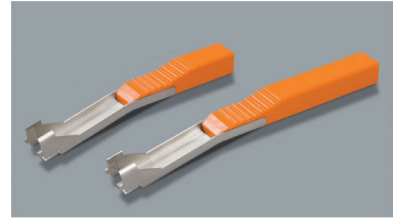

STEP 3: For extraction use the tool part number 057-0289-00 A or B.

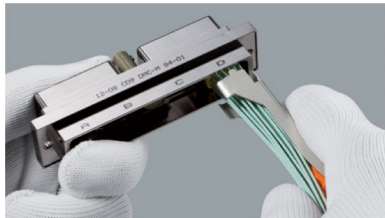

STEP 4: Slide the tool around the cable. Then push the tool inside the housing until butting.



STEP 5: Note the different tool's position depending on the A, B, C or D cavities.

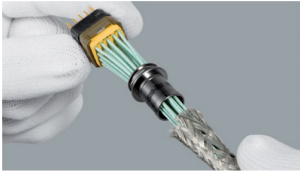

STEP 6: Press the cable between the tool and the fingers and pull the overall back. If the module is not wired, use the same tool, but push the module from the front of the housing.

SHIELDED BRAID MOUNT ON CHIMNEY (NOTE: 4-WAY MODULE SHOWN)

STEP 1: Slide the chimney and the shielded braid around the cable.

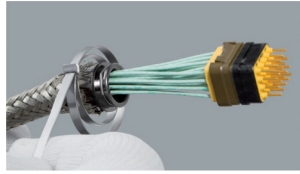

STEP 2: Slide the shielded braid and the 3 mm “band it” ring over the chimney.

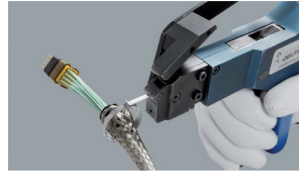

STEP 3: Use the tool part number 057-0450-00 to tighten the ring around the shielded braid over the chimney.

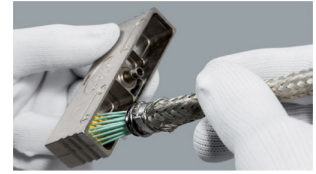

STEP 4: Clip the module in the housing.

TE Connectivity DEUTSCH

2 or 4 Way Module EN4165 Connectors



INHERENT FLEXIBILITY ALLOWS FOR NEW AEROSPACE APPLICATIONS

The DMC-M has set the modular connector standard in the Aerospace & Military industries since the 1980's, and is now standardized by European Specification EN4165.

The DMC-M 2 or 4 Way Module is a rectangular modular connector that continues to attract new users and applications because of its inherent flexibility, space/weight savings and robustness. In addition, this product range has increased to offer composite housings, aluminum wire capability and shunting configurations. The modularity of the DMC-M allows you to configure and build your own part numbers from a set of standard elements. You are also able to customize and develop designs for special applications by modifying housing. DMC-M housings are available in aluminum alloy or composite, and nickel or cadmium plating finishes to resist severe environments. Screening and electromagnetic protection is guaranteed 360 degrees around. Designed with a lightweight material and metal plating, the 2 or 4 Way Module DMC-M is ideal for weight and mass saving.

APPLICATIONS

- Cabin and avionic systems
- High-performance military aircraft
- Commercial airlines
- Communications equipment
- Missiles
- Military
- Railway
- Medical

FEATURES

- Light weight composite
- Modularity
- Color and mechanical coded
- Push-pull coupling
- Aluminum cable contact compliant

MATERIALS AND FINISHES

Housing Material	Aluminum alloy or Composite
Plating Finish	Black nickel (F) Olive drab cadmium (W) Nickel on composite (M) Olive drab on composite (J)
Module Material	Thermoplastic and fluorinated silicone
Gasket Material	Conductive silicone (only for shielded versions)
Contact	Copper alloy
Contact Plating Finish	Gold over nickel

ELECTRICAL DATA

Withstanding Voltage At Sea Level	Service Rating I - 1300V 50Hz (R.M.S.) module size 22 Service Rating II - 1500V 50Hz (R.M.S.) modules sizes 20, 16, 12, and 8
Withstanding Voltage Altitude Immersion to 121 hPa	Service Rating I - 1000V 50Hz (R.M.S.) module size 22 Service Rating II - 1000V 50Hz (R.M.S.) modules sizes 20, 16, 12, and 8
Insulation Resistance At Sea Level	≥ 5000MΩ
Insulation Resistance Altitude Immersion to 121 hPa	≥ 1000MΩ
Contact Maximum Current Sealed Version	Size 22 - 5.0A Size 20 - 7.5A Size 16 - 13.0A Size 12 - 23.0A Size 8 - 46.0A (up to 90A with specific contacts)

(Characteristics as per EN4165 & EN3155)

EMI Shielding Performance

FREQUENCY (MHz)	MINIMUM ATTENUATION (dB)	
	MODELS F - W	MODELS J - M
100	80	65
200	78	60
300	78	55
400	77	55
800	75	45
1000	75	45
1500	59	43
2000	55	40
3000	51	37
4000	48	35
6000	45	33
10000	40	30

MECHANICAL DATA

Module Retention	In housing - $\geq 25.4\text{daN}$
Contact Retention In Module	Size 22 - 4.5daN
	Size 20 - 9.0daN
	Size 16 - 11.0daN
	Size 12 - 13.0daN
	Size 8 - 15.6daN
Coupling Endurance	500 mating cycles
Vibration	20 g
Shock	100 g
Salt Spray	96 hours (class F)
	500 hours (class W, M, J)
Service Temperature	-55°C to $+175^{\circ}\text{C}$

(Characteristics as per EN4165)

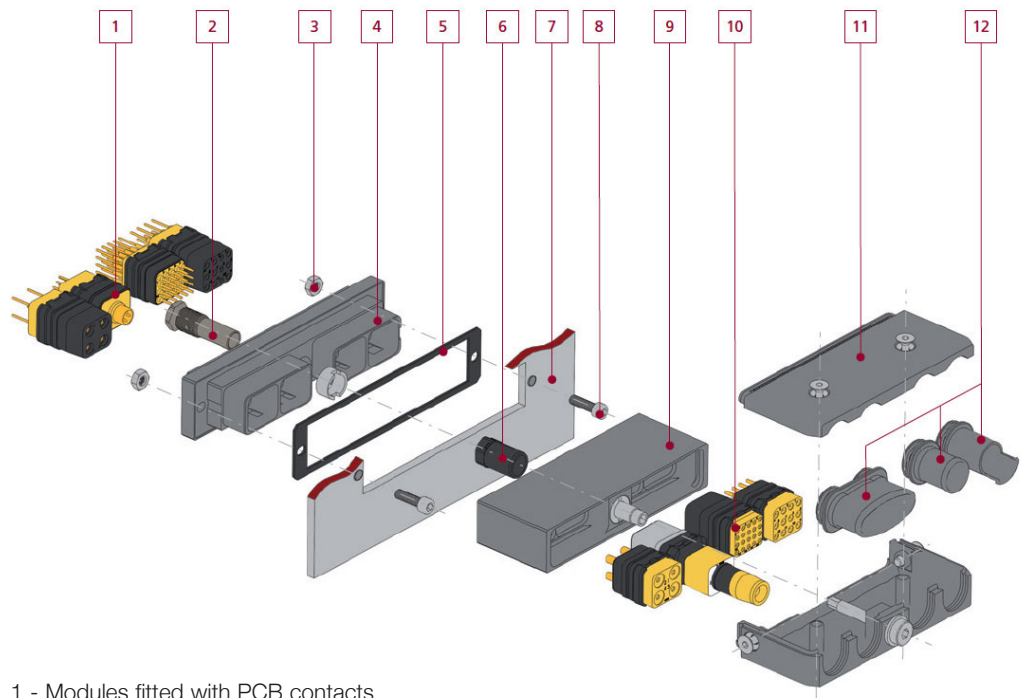

- 1 - Modules fitted with PCB contacts
- 2 - Receptacle keying component
- 3 - Fixing panel nuts
- 4 - Receptacle housing
- 5 - Conductive flat gasket
- 6 - Plug keying component
- 7 - Panel
- 8 - Fixing panel screws
- 9 - Plug housing
- 10 - Modules fitted with crimped contacts
- 11 - Accessory in 2 halves
- 12 - Chimneys

HOW TO ORDER RECEPTACLE HOUSING COMMERCIAL

	1	2	3	4	5	6*		7**
DMC-M	D	84	B	3	5	W	01	****
CONNECTOR TYPE	SHIELDING	HOUSING TYPE	DELIVERY CONFIGURATION	KEYING COMPONENT TYPE	KEYING COMPONENT ORIENTATION	PLATING FINISH*	ISSUE	SPECIAL MODIFICATIONS**

Example part number: DMC-MD 84 B 35 W 01

STEP 1: CHOOSE SHIELDING

OMIT
Standard

D
Shielded

STEP 2: CHOOSE HOUSING TYPE

42
Receptacle housing
2 module

43
Short receptacle
housing 2 module

44
Flange mounting
receptacle housing
2 module

45
Short flange
mounting receptacle
housing 2 module

82
Receptacle housing
4 module

83
Short receptacle
housing 4 module

84
Flange mounting
receptacle housing
4 module

85
Short flange
mounting receptacle
housing 4 module

STEP 3: CHOOSE DELIVERY CONFIGURATION

Omit or B00
Receptacle housing delivered with
the standard keying component
not mounted

A
Receptacle housing delivered
without keying component

B
Receptacle housing delivered
with keying component coded,
mounted or not mounted

STEP 4: CHOOSE KEYING COMPONENT TYPE (ONLY FOR B CONFIGURATION)

0
Standard keying
component type 0
(black color)

1
Keying component
type 1 (purple color)

2
Keying component
type 2 (yellow color)

3
Keying component
type 3 (green color)

4
Keying component
type 4 (blue color)

5
Keying component
type 5 (orange color)

6
Keying component
type 6 (white color)

STEP 5: CHOOSE KEYING COMPONENT ORIENTATION - RECEPTACLE HOUSING

0
Not mounted

See right for configuration
Mounted

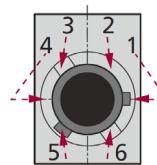

Receptacle housing view from front face
Orientation is indicated by the largest keyway

* Composite version, contact us.
** More information, contact us.

STEP 6: CHOOSE PLATING FINISH*

Aluminum Alloy:

OMIT
Black nickel

W
Olive drab cadmium

STEP 7: CHOOSE SPECIAL MODIFICATIONS**

A1064
Electroless nickel

* Composite version, contact us.
** More information, contact us.

RECEPTACLE KEYING

DMC-M receptacle housings can be delivered with a keying component allowing 6 mating possibilities. An additional 6 keying orientations are possible providing a total of 36 keying options thereby preventing connector misalignment and mismounting. This is especially useful for rack and multi connector applications.

RECEPTACLE KEYING COMPONENT

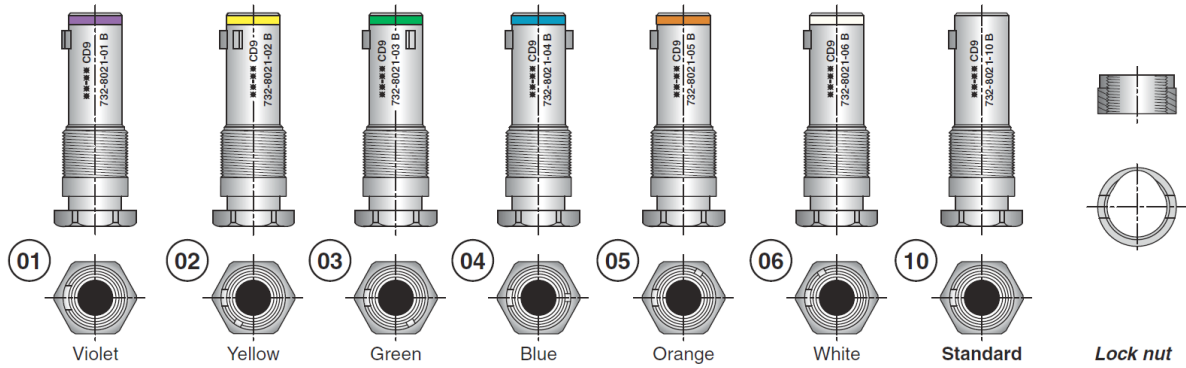

The assembly coupling mechanism requires the use of the tool part number 057-0590-80. It is delivered with a removable lock nut (coupling torque 0.1 to 0.13 daN.m).

PART NUMBERING SYSTEM

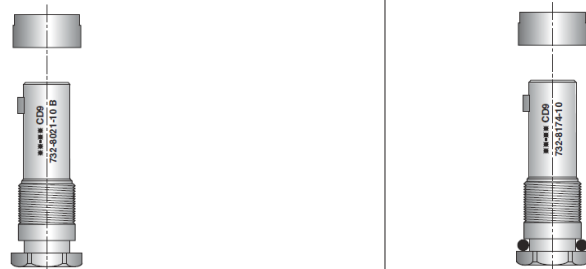

VERSION	DEUTSCH STANDARD VERSION	EN STANDARD VERSION	DEUTSCH SEALED VERSION
MATERIAL	ALUMINUM ALLOY AND STAINLESS STEEL LOCK NUT		
01	732-8021-01 B	EN4165R01	732-8174-01
02	732-8021-02 B	EN4165R02	732-8174-02
03	732-8021-03 B	EN4165R03	732-8174-03
04	732-8021-04 B	EN4165R04	732-8174-04
05	732-8021-05 B	EN4165R05	732-8174-05
06	732-8021-06 B	EN4165R06	732-8174-06
10	732-8021-10 B	EN4165R10	732-8174-10

HOW TO ORDER PLUGS COMMERCIAL

	1	2	3	4	5	6*		7**
DMC-M	D	89	B	3	5	W	01	****
CONNECTOR TYPE	SHIELDING	HOUSING TYPE	DELIVERY CONFIGURATION	KEYING COMPONENT TYPE	KEYING COMPONENT ORIENTATION	PLATING FINISH	ISSUE	SPECIAL MODIFICATIONS

Example part number: DMC-MD 89 B 35 W 01

STEP 1: CHOOSE SHIELDING

OMIT
Standard

D
Shielded

STEP 2: CHOOSE HOUSING TYPE

40
Free plug 2 module

48
Rack and panel plug 2 module

49
Reversed rack and panel plug 2 module

80
Free plug 4 module

88
Rack and panel plug 4 module

89
Reversed rack and panel 4 module

STEP 3: CHOOSE DELIVERY CONFIGURATION

Omit or B00
Plug housing delivered with the standard keying component not mounted

A
Plug housing delivered without keying component

B
Plug housing delivered with keying component coded, mounted or not mounted

STEP 4: CHOOSE KEYING COMPONENT TYPE (ONLY FOR B CONFIGURATION)

0
Standard keying component type 0 (black color)

1
Keying component type 1 (purple color)

2
Keying component type 2 (yellow color)

3
Keying component type 3 (green color)

4
Keying component type 4 (blue color)

5
Keying component type 5 (orange color)

6
Keying component type 6 (white color)

*Composite version, contact us.
** More information, contact us.

STEP 5: CHOOSE KEYING COMPONENT ORIENTATION - PLUG HOUSING

0

Not mounted

See right for configuration

Mounted

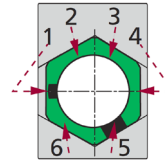

Plug housing view from front face
Orientation is indicated by the largest keyway

STEP 6: CHOOSE PLATING FINISH*

Aluminum Alloy:

OMIT

Black nickel

W

Olive drab cadmium

Composite*:

(not for rack and panel plugs)

M

Nickel on composite

J

Olive drab cadmium on composite

STEP 7: CHOOSE SPECIAL MODIFICATIONS**

A1064

Electroless nickel

* Composite version, contact us.

** More information, contact us.

PLUG KEYING

DMC-M plug housings can be delivered with a keying component allowing 6 mating possibilities. An additional 6 keying orientations are possible providing a total of 36 keying options thereby preventing connector misalignment and mismatching. This is especially useful for rack and multi connector applications.

PLUG KEYING COMPONENT

The assembly of these keys does not require the use of a tool. Once clipped into their cavities, these keys must be broken to be removed.

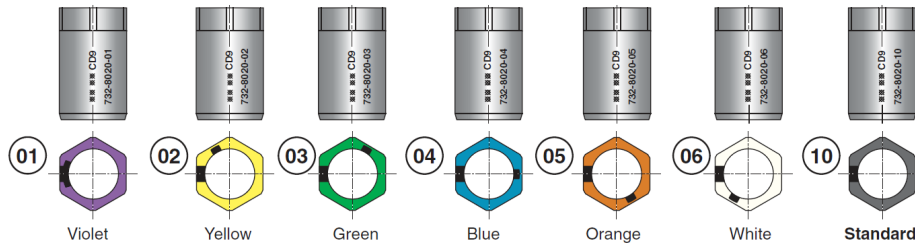

PART NUMBERING SYSTEM		
VERSION	DEUTSCH PART NUMBER	EN PART NUMBER
01	732-8020-01	EN4165P01
02	732-8020-02	EN4165P02
03	732-8020-03	EN4165P03
04	732-8020-04	EN4165P04
05	732-8020-05	EN4165P05
06	732-8020-06	EN4165P06
10	732-8020-10	EN4165P10

HOW TO ORDER SHIELDED ACCESSORIES COMMERCIAL

1	2	3		
732-	8052-	00	W	A
DMC-M FAMILY	ACCESSORY	CHIMNEY	PLATING FINISH	ISSUE

Example part number: 732-8052-00 WA

STEP 1: CHOOSE ACCESSORY

8052

Accessory for free plug

8053

Accessory for rack and panel plug

8054

Accessory for receptacle housing

STEP 2: CHOOSE CHIMNEY

00

4 module version equipped with 4 round chimneys

01

2 module version equipped with 2 round chimneys

10

4 module version supplied without chimney

14

2 module version supplied without chimney

STEP 3: CHOOSE PLATING FINISH

Aluminum Alloy:

OMIT

Black nickel

W

Olive drab cadmium

Composite:

(only for free plug accessory)

M

Nickel on composite

J

Olive drab cadmium on composite

HOW TO ORDER METAL NON-SHIELDED CABLE CLAMPS COMMERCIAL

732-	8002-	1 00	2 W
DMC-M FAMILY	METAL VERSION	COMPOSITION	PLATING FINISH

Example part number: 732-8002-00 W

STEP 1: CHOOSE COMPOSITION

00

4 module version

01

2 module version

STEP 2: CHOOSE PLATING FINISH

OMIT

Black nickel

W

Olive drab cadmium

HOW TO ORDER ULTEM NON-SHIELDED CABLE CLAMPS PN COMMERCIAL

732-	8040-	1 00
DMC-M FAMILY	ULTEM VERSION	COMPOSITION

STEP 1: CHOOSE COMPOSITION

00 A



















4 module version

01



















2 module version

MODULES

PIN CONTACTS PER AS39029/58 AND EN3155

MODULES	DETAILS	PART NUMBER CROSS
	20 contacts size 22	DMC-M 20-22 AN BAC10BC2022PNB EN4165A20-221NA
	20 contacts size 22	DMC-MA 20-22 AN EN4165A20A221NA
	12 contacts size 20	DMC-M 12-20 AN BAC10BC1220PNB EN4165A12-201NA
	8 contacts size 16	DMC-M 08-16 AN BAC10BC0816PNB EN4165A08-161NA
	4 contacts size 12	DMC-M 04-12 AN EN4165A04-121NA
	1 contact size 8	DMC-M 01-08 AN EN4165A01-081NA
	6 contacts size 16 2 contacts size 22 8 contacts size 24	DMC-M 16-02 AN 2226454-1
	6 contacts size 16 5 contacts size 22	DMC-M 99-01 AN BAC10BC1622PNB EN4165A99-011NA
	6 contacts size 16 5 contacts size 22	DMC-MA 99-01 AN EN4165A99A011NA
	8 contacts size 22 3 contacts size 20	DMC-M 99-02 AN
	8 contacts size 20 8 contacts size 24	DMC-M 99-03 AN
	6 contacts size 20 2 contacts size 22 8 contacts size 24	DMC-M 99-04 AN
	8 contacts size 22 2 contacts size 12	DMC-M 99-06 AN BAC10BC1001PNB
	8 contacts size 20 2 contacts size 16	DMC-M 99-10 AN EN4165A99-101NA
	6 optical contacts	DMC-M MC5 AN
	2 optical contacts 5 contacts size 16 2 contacts size 22	DMC-M T47 AN
	12 or 24 optical contacts for round or ribbon cable	Hermaphrodite DMC-M MC6
	Blanking module	DMC-M 00-00 PN EN4165-1N

SOCKET CONTACTS PER AS39029/57 AND EN3155

MODULES	DETAILS	PART NUMBER CROSS
	20 contacts size 22	DMC-M 20-22 BN BAC10BC2022SNB EN4165 20-22 A1NB
	20 contacts size 22	DMC-MA 20-22 BN EN4165A20A221NB
	12 contacts size 20	DMC-M 12-20 BN BAC10BC1220SNB EN4165A12-201NB
	8 contacts size 16	DMC-M 08-16 BN BAC10BC0816SNB EN4165A08-161NB
	4 contacts size 12	DMC-M 04-12 BN EN4165A04-121NB
	1 contact size 8	DMC-M 01-08 BN EN4165A01-081NB
	6 contacts size 16 2 contacts size 22 8 contacts size 24	DMC-M 16-02 BN 2226455-1
	6 contacts size 16 5 contacts size 22	DMC-M 99-01 BN BAC10BC1622SNB EN4165A99-011NB
	6 contacts size 16 5 contacts size 22	DMC-MA 99-01 BN EN4165A99A011NB
	8 contacts size 22 3 contacts size 20	DMC-M 99-02 BN
	8 contacts size 20 8 contacts size 24	DMC-M 99-03 BN
	6 contacts size 20 2 contacts size 22 8 contacts size 24	DMC-M 99-04 BN
	8 contacts size 22 2 contacts size 12	DMC-M 99-06 BN BAC10BC1001SNB
	8 contacts size 20 2 contacts size 16	DMC-M 99-10 BN EN4165A99-101NB
	6 optical contacts	DMC-M MC5 BN
	2 optical contacts 5 contacts size 16 2 contacts size 22	DMC-M T47 BN
	20 contacts size 22 5 shunts 4 ways	DMC-M 22-05 BN EN4165A20Y221NB
	20 contacts size 22 3 shunts 4 ways 4 shunts 2 ways	DMC-M 22-07 BN EN4165A2AY221NB
	20 contacts size 22 10 shunts 2 ways	DMC-M 22-10 BN EN4165A2BY221NB

Aluminum Cable Technology
High Speed Modules
Distribution Shunt Modules

Note: 1) DMC-M modules are compatible with Aluminum Cable contacts and with EN3155-70 / 71 size 22. 2) Distribution shunt modules use dedicated contacts based on standard M39029. 3) DMC-M 99-02, 99-03, 99-04, 16-02 are specific modules for high speed Ethernet application.

TE/DEUTSCH Part Numbers (DMC-M / 787)
BOEING Part Numbers (BAC10)
STANDARD Part Numbers (EN4165)

	1*	2	3	4	5	6
EN4165	W	7	A	4	3	5
NUMBER OF THE STANDARD	PLATING FINISH	HOUSING TYPE	SERIES	COMPOSITION	KEYING COMPONENT TYPE	HOUSING COMPONENT ORIENTATION IN THE RECEPTACLE HOUSING

Example part number: EN4165W7A435

STEP 1: CHOOSE PLATING FINISH*

Aluminum Alloy:

F
Black nickel

W
Olive drab cadmium

Composite*:
(only for free plug accessory)

M
Nickel on composite

J
Olive drab cadmium on composite

STEP 2: CHOOSE HOUSING TYPE

0
Receptacle housing

7
Flange mounting receptacle housing

STEP 3: CHOOSE SERIES

A
Series 2

B**
Series 3

STEP 4: CHOOSE COMPOSITION

2
2 module version

4
4 module version

STEP 5: CHOOSE KEYING COMPONENT TYPE

A
Standard keying component type (black color)

0
Without keying component

1
Keying component type 1 (purple color)

2
Keying component type 2 (yellow color)

3
Keying component type 3 (green color)

4
Keying component type 4 (blue color)

5
Keying component type 5 (orange color)

6
Keying component type 6 (white color)

* Composite version, contact us.

** Series 3, contact us.

STEP 6: CHOOSE KEYING COMPONENT ORIENTATION -RECEPTACLE HOUSING

0

Not mounted

See right for configuration

Mounted

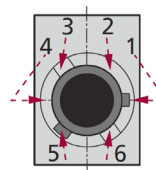

Receptacle housing view from front face
Orientation is indicated by the largest keyway

RECEPTACLE KEYING

DMC-M receptacle housings can be delivered with a keying component allowing 6 mating possibilities. An additional 6 keying orientations are possible providing a total of 36 keying options thereby preventing connector misalignment and mismounting. This is especially useful for rack and multi connector applications.

RECEPTACLE KEYING COMPONENT

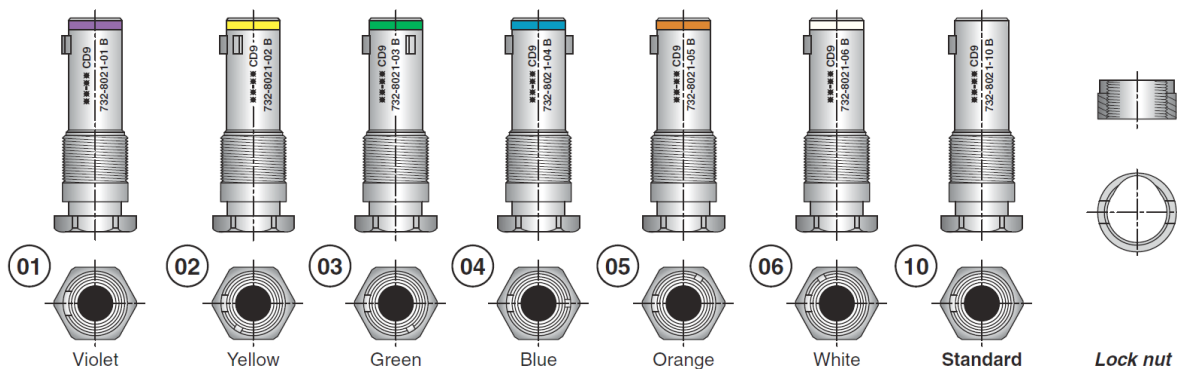

The assembly coupling mechanism requires the use of the tool part number 057-0590-80. It is delivered with a removable lock nut (coupling torque 0.1 to 0.13 daN.m).

PART NUMBERING SYSTEM

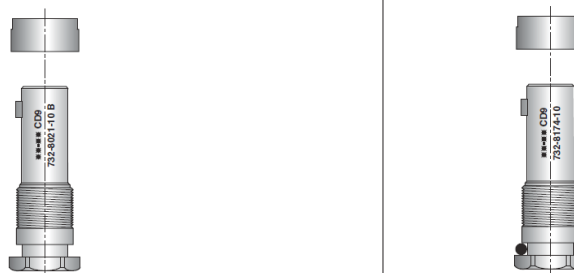

VERSION	DEUTSCH STANDARD VERSION	EN STANDARD VERSION	DEUTSCH SEALED VERSION
MATERIAL	ALUMINUM ALLOY AND STAINLESS STEEL LOCK NUT		
01	732-8021-01 B	EN4165R01	732-8174-01
02	732-8021-02 B	EN4165R02	732-8174-02
03	732-8021-03 B	EN4165R03	732-8174-03
04	732-8021-04 B	EN4165R04	732-8174-04
05	732-8021-05 B	EN4165R05	732-8174-05
06	732-8021-06 B	EN4165R06	732-8174-06
10	732-8021-10 B	EN4165R10	732-8174-10

HOW TO ORDER PLUGS - EN4165

	1*	2	3**	4	5	6	7
EN4165	W	9	A	4	R	3	5
NUMBER OF THE STANDARD	PLATING FINISH	HOUSING TYPE	SERIES	COMPOSITION	REVERSED	KEYING COMPONENT TYPE	KEYING COMPONENT ORIENTATION

Example part number: EN4165W9A4R35

STEP 1: CHOOSE PLATING FINISH*

Aluminum Alloy:

F
Black nickel

W
Olive drab cadmium

Composite*: (not for rack and panel plugs)

M
Nickel on composite

J
Olive drab cadmium on composite

STEP 2: CHOOSE HOUSING TYPE

6
Free plug

9
Rack and panel plug

STEP 3: CHOOSE SERIES**

A
Series 2

B**
Series 3

STEP 4: CHOOSE COMPOSITION

2
2 module version

4
4 module version

STEP 5: CHOOSE REVERSED

Omit
Standard

R
Reversed

* Composite version, contact us.

** Series 3, contact us.

STEP 6: CHOOSE KEYING COMPONENT TYPE

A

Standard keying component type (black color)

0

Without keying component

1

Keying component type 1 (purple color)

2

Keying component type 2 (yellow color)

3

Keying component type 3 (green color)

4

Keying component type 4 (blue color)

5

Keying component type 5 (orange color)

6

Keying component type 6 (white color)

STEP 7: CHOOSE KEYING COMPONENT ORIENTATION - PLUG HOUSING

0

Not mounted

See right for configuration

Mounted

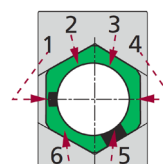

Plug housing view from front face
Orientation is indicated by the largest keyway

PLUG KEYING

DMC-M plug housings can be delivered with a keying component allowing 6 mating possibilities. An additional 6 keying orientations are possible providing a total of 36 keying options thereby preventing connector misalignment and mismatching. This is especially useful for rack and multi connector applications.

PLUG KEYING COMPONENT

The assembly of these keys does not require the use of a tool. Once clipped into their cavities, these keys must be broken to be removed.

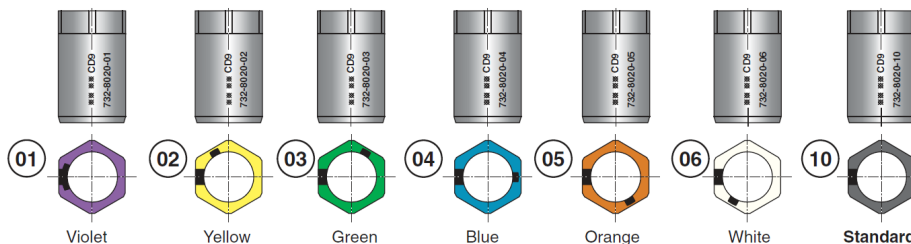

PART NUMBERING SYSTEM		
VERSION	DEUTSCH PART NUMBER	EN PART NUMBER
01	732-8020-01	EN4165P01
02	732-8020-02	EN4165P02
03	732-8020-03	EN4165P03
04	732-8020-04	EN4165P04
05	732-8020-05	EN4165P05
06	732-8020-06	EN4165P06
10	732-8020-10	EN4165P10

HOW TO ORDER SHIELDED ACCESSORY BODIES - EN4165

1	2	3		
EN4165	F	14	P	4
NUMBER OF THE STANDARD	PLATING FINISH	SHIELDED ACCESSORY BODY	PLUG	COMPOSITION

Example part number: EN4165F14P4

STEP 1: CHOOSE PLATING FINISH

Aluminum Alloy:

F
Black nickel

W
Olive drab cadmium

Composite: (only for free plug accessory)

M
Nickel on composite

J
Olive drab cadmium on composite

STEP 2: CHOOSE PLUG

P
For free plug

R
For receptacle & rack and panel plug

STEP 3: CHOOSE COMPOSITION

2
2 module version

4
4 module version

HOW TO ORDER NON-SHIELDED CABLE CLAMPS - EN4165

1	2*	3		
EN4165	F	13	A	4
NUMBER OF THE STANDARD	PLATING FINISH	CABLE CLAMP	MODULE SERIES	COMPOSITION

STEP 1: CHOOSE PLATING FINISH

F
Black nickel

W
Olive drab cadmium

STEP 2: CHOOSE MODULE SERIES*

A
Series 2

B*
Series 3

STEP 3: CHOOSE COMPOSITION



















2
2 module version

4
4 module version



















*Series 3, contact us.

MODULES

PIN CONTACTS PER AS39029/58 AND EN3155

MODULES	DETAILS	PART NUMBER CROSS
	20 contacts size 22	DMC-M 20-22 AN BAC10BC2022PNB EN4165A20-221NA
	20 contacts size 22	DMC-MA 20-22 AN EN4165A20A221NA
	12 contacts size 20	DMC-M 12-20 AN BAC10BC1220PNB EN4165A12-201NA
	8 contacts size 16	DMC-M 08-16 AN BAC10BC0816PNB EN4165A08-161NA
	4 contacts size 12	DMC-M 04-12 AN EN4165A04-121NA
	1 contact size 8	DMC-M 01-08 AN EN4165A01-081NA
	6 contacts size 16 2 contacts size 22 8 contacts size 24	DMC-M 16-02 AN 2226454-1
	6 contacts size 16 5 contacts size 22	DMC-M 99-01 AN BAC10BC1622PNB EN4165A99-011NA
	6 contacts size 16 5 contacts size 22	DMC-MA 99-01 AN EN4165A99A011NA
	8 contacts size 22 3 contacts size 20	DMC-M 99-02 AN
	8 contacts size 20 8 contacts size 24	DMC-M 99-03 AN
	6 contacts size 20 2 contacts size 22 8 contacts size 24	DMC-M 99-04 AN
	8 contacts size 22 2 contacts size 12	DMC-M 99-06 AN BAC10BC1001PNB
	8 contacts size 20 2 contacts size 16	DMC-M 99-10 AN EN4165A99-101NA
	6 optical contacts	DMC-M MC5 AN
	2 optical contacts 5 contacts size 16 2 contacts size 22	DMC-M T47 AN
	12 or 24 optical contacts for round or ribbon cable	Hermaphrodite DMC-M MC6
	Blanking module	DMC-M 00-00 PN EN4165-1N

SOCKET CONTACTS PER AS39029/57 AND EN3155

MODULES	DETAILS	PART NUMBER CROSS
	20 contacts size 22	DMC-M 20-22 BN BAC10BC2022SNB EN4165 20-22 A1NB
	20 contacts size 22	DMC-MA 20-22 BN EN4165A20A221NB
	12 contacts size 20	DMC-M 12-20 BN BAC10BC1220SNB EN4165A12-201NB
	8 contacts size 16	DMC-M 08-16 BN BAC10BC0816SNB EN4165A08-161NB
	4 contacts size 12	DMC-M 04-12 BN EN4165A04-121NB
	1 contact size 8	DMC-M 01-08 BN EN4165A01-081NB
	6 contacts size 16 2 contacts size 22 8 contacts size 24	DMC-M 16-02 BN 2226455-1
	6 contacts size 16 5 contacts size 22	DMC-M 99-01 BN BAC10BC1622SNB EN4165A99-011NB
	6 contacts size 16 5 contacts size 22	DMC-MA 99-01 BN EN4165A99A011NB
	8 contacts size 22 3 contacts size 20	DMC-M 99-02 BN
	8 contacts size 20 8 contacts size 24	DMC-M 99-03 BN
	6 contacts size 20 2 contacts size 22 8 contacts size 24	DMC-M 99-04 BN
	8 contacts size 22 2 contacts size 12	DMC-M 99-06 BN BAC10BC1001SNB
	8 contacts size 20 2 contacts size 16	DMC-M 99-10 BN EN4165A99-101NB
	6 optical contacts	DMC-M MC5 BN
	2 optical contacts 5 contacts size 16 2 contacts size 22	DMC-M T47 BN
	20 contacts size 22 5 shunts 4 ways	DMC-M 22-05 BN EN4165A20Y221NB
	20 contacts size 22 3 shunts 4 ways 4 shunts 2 ways	DMC-M 22-07 BN EN4165A2AY221NB
	20 contacts size 22 10 shunts 2 ways	DMC-M 22-10 BN EN4165A2BY221NB

Aluminum Cable Technology
High Speed Modules
Distribution Shunt Modules

Note: 1) DMC-M modules are compatible with Aluminum Cable contacts and with EN3155-70 / 71 size 22. 2) Distribution shunt modules use dedicated contacts based on standard M39029. 3) DMC-M 99-02, 99-03, 99-04, 16-02 are specific modules for high speed Ethernet application.

TE/DEUTSCH Part Numbers (DMC-M / 787)
BOEING Part Numbers (BAC10)
STANDARD Part Numbers (EN4165)

CONTACTS

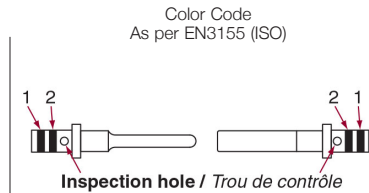
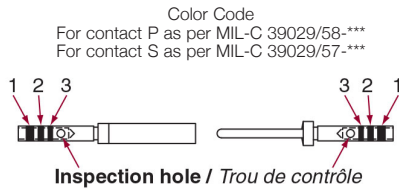

CONTACTS								CABLES	
PART NUMBER DEUTSCH	TYPE	SIZE	COLOR CODES AS PER MIL			COLOR CODES AS PER EN3155		Ø OVER INSULATION IN/MM (GAUGE AWG)	WIRE SECTION IN/ MM²
			1	2	3	1	2		
724-0001-22	P	22/22	Orange	Blue	Black	-	-	0.71 to 1.37 (22 - 26)	0.095 to 0.40
724-0003-22	S		Orange	Green	Yellow	-	-		
182-0860-22	P	22/20	-	-	-	Red	Green	0.71 to 1.37 (22 - 26)	0.095 to 0.40
182-0862-22	S		-	-	-				
724-0001-20	P	20/20	Orange	Blue	Orange	-	-	0.85 to 2.11 (20 - 24)	0.25 to 0.60
724-0003-20	S		Orange	Green	Violet	-	-		
724-1063-20	P	20/18	-	-	-	Red	Brown	(18 - 24)	0.25 to 1.00
724-1064-20	S		-	-	-				
724-0001-16	P	16/16	Orange	Blue	Yellow	-	-	1.20 to 2.77 (16 - 20)	0.60 to 1.20
724-0003-16	S		Orange	Green	Gray	-	-		
724-1063-16	P	16/14	-	-	-	Blue	White	(14 - 20)	0.60 to 2.00
724-1064-16	S		-	-	-				
724-0001-12	P	12/12	Orange	Blue	Green	-	-	1.90 to 3.61 (12 - 14)	2.00 to 3.00
724-0003-12	S		Orange	Green	White	-	-		
724-1063-12	P	12/10	-	-	-	Yellow	White	1.90 to 2.90 (14 - 10)	2.00 to 5.00
724-1064-12	S		-	-	-				
724-0001-08	P	Power 8	-	-	-	-	-	3.80 to 5.15 (8)	5.30 to 8.98
724-0003-08	S		-	-	-	-	-		
182-0001-08	P	Power 8	-	-	-	-	-	3.80 to 5.15 (8)	5.30 to 8.98
182-0003-08	S		-	-	-	-	-		
724-0004-16	P	Micro-Coax 16	Yellow	Red	Yellow	-	-	KX 22	0.057 to 0.158
724-0005-16	S		Yellow	Orange	Red	-	-		
182-0125-08	P	8	-	-	-	-	-	ALPEN A 26 DT	-
182-0126-08	S		-	-	-	-	-		
182-0048-08	P	8	-	-	-	-	-	Interface SMA	-
182-0044-08	S		-	-	-	-	-		
724-1272-22	S	Shunt 22	-	-	-	-	-	0.71 to 1.37 (22 - 26)	0.095 to 0.40

DATABUS CONTACTS

DATABUS CONTACTS (TWISTED PAIR) AS PER MIL-C 38999 SERIES I, III AND IV STANDARD						
CONTACTS				CABLES		
PART NUMBER	TYPE	SIZE	COLOR CODE	TYPES	CONDUCT. MAX. SECTION	BRAID Ø MAX.
182-0034-03	P	8	Brown-Red	Braid Simple	2 x 0.34 mm²	3.48
182-0035-03	S					
182-0034-04	P	8	Red-Red	High Immunity Double Braid	2 x 0.34 mm²	3.91
182-0035-04	S					

Part numbers in red - Standard contacts delivered with modules

Note: Contacts for aluminium cable, contact us.

CONTACTS AND TOOLING



CONTACTS	TOOLING				
PART NUMBER DEUTSCH	CRIMPING TOOL P/N DEUTSCH	CRIMPING TOOL P/N MIL	LOCATOR P/N DEUTSCH	LOCATOR P/N MIL	INSERTION AND EXTRACTION TOOL
724-0001-22	057-0463-12	M22520/2-01	057-0467-32	M22520/2-09	M81969/14-01
724-0003-22			057-0515-32	M22520/2-06	
182-0860-22	057-0463-12	M22520/2-01	057-0467-32	M22520/2-09	M81969/14-01
182-0862-22					
724-0001-20	057-0461-11	M22520/1-01	057-0466-21	M22520/1-04	M15570-20
724-0003-20					
724-1063-20	057-0461-11	M22520/1-01	056-0466-21	M22520/1-04	-
724-1064-20					
724-0001-16	057-0461-11	M22520/1-01	057-0466-21	M22520/1-04	M15570-16
724-0003-16					
724-1063-16	057-0461-11	M22520/1-01	056-0466-21	M22520/1-04	-
724-1064-16					
724-0001-12	057-0461-11	M22520/1-01	057-0466-21	M22520/1-04	M15570-12
724-0003-12					
724-1063-12	057-0461-11	-	056-0466-21	M22520/1-04	-
724-1064-12					
724-0001-08	057-0064-05 A	-	057-0065-05 A	-	114-008 or M81969/14-06
724-0003-08					
182-0001-08	057-0064-05 A	-	057-0065-05 A	-	114-008 or M81969/14-06
182-0003-08					
724-0004-16	057-0463-12*	-	057-0539-32*	-	M15570-16
724-0005-16	057-0509-14**		057-0511-34**		
182-0125-08	-	-	-	-	-
182-0126-08	-	-	-	-	-
182-0048-08	-	-	-	-	-
182-0044-08	-	-	-	-	-
724-1272-22	057-0463-12	M22520/2-01	057-0467-32	M22520/2-09	M81969/14-01

Part numbers in red - Standard contacts delivered with modules
 *For central contact **For exterior contact

DATABUS CONTACTS

DATABUS CONTACTS (TWISTED PAIR) AS PER MIL-C 38999 SERIES I, III AND IV STANDARD			
SLEEVE TYPE	CRIMPING TOOL CENTRAL CONDUCTOR	CRIMPING TOOL FERRULE	INSERTION AND EXTRACTION TOOL
Thermoplastic and silicone	TDB-CY-08	TDB-CT-HEX Mark C	114-008 or M81969/14-06
Thermoplastic and silicone	TDB-CT-08	TDB-CT-HEX Mark D	114-008 or M81969/14-06

STACKABLE RECEPTACLE HOUSING

DMC-M 82-01
4 Module Version

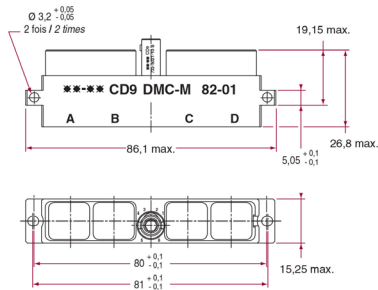

DMC-M 42-01
2 Module Version

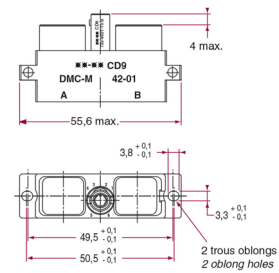

SHORT STACKABLE RECEPTACLE HOUSINGS

DMC-M 83-01
4 Module Version

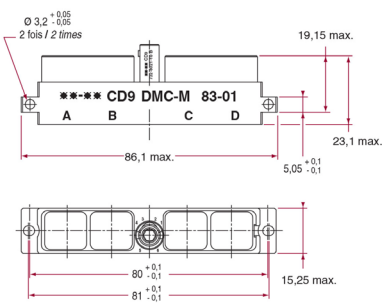

DMC-M 43-01
2 Module Version

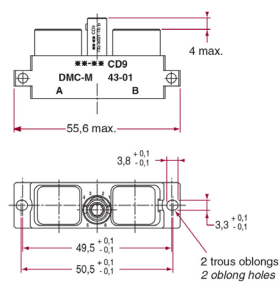

FLANGE MOUNTING RECEPTACLE HOUSINGS

DMC-M 84-01
4 Module Version*

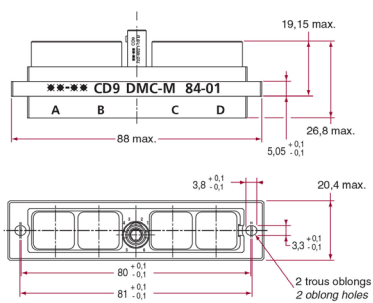

DMC-M 44-01
2 Module Version*

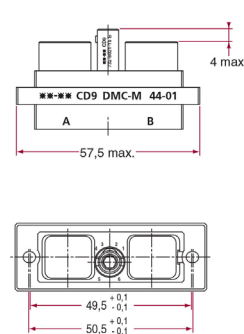

SHORT FLANGE MOUNTING RECEPTACLE HOUSINGS

DMC-M 85-01
4 Module Version*

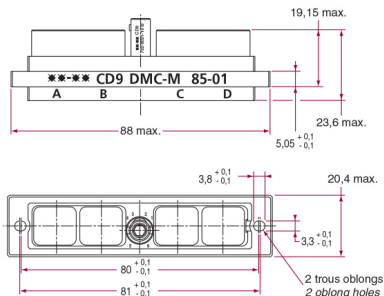

DMC-M 45-01
2 Module Version*

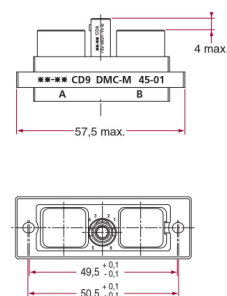

*DMC-MD shielded version (D): delivered with a conductive flat gasket part number 108-0019-00 A1142 for the 4 module version and 108-0019-01 A1142 for the 2 module version. Also, there is a sealing flat gasket part number 108-0019-00 for the 4 module version and 108-0019-01 for the 2 module version, not supplied with receptacles. **Note:** No accessory can be mounted on the rear of short receptacle housing.

MULTI-RECEPTACLE HOUSINGS

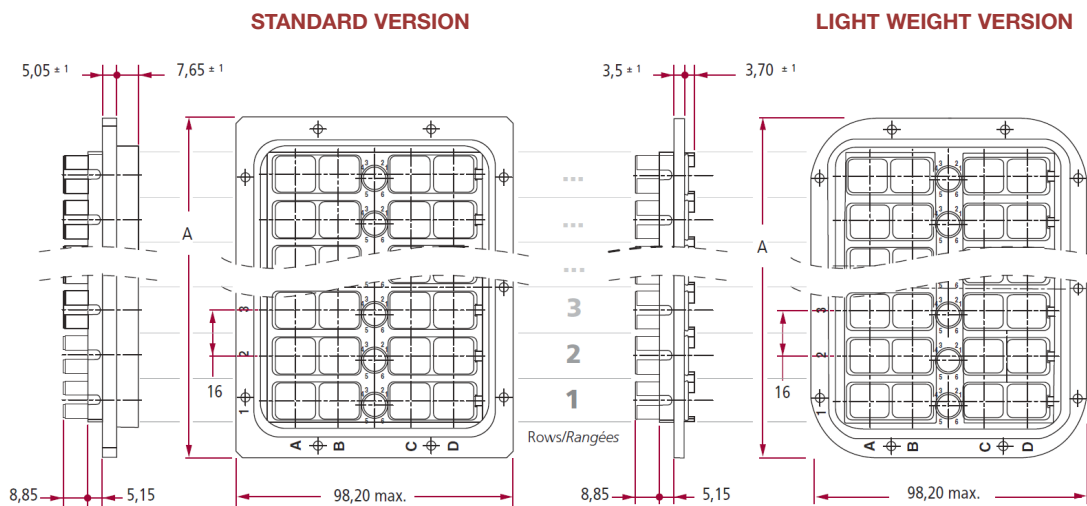

Note: These multi-receptacle housing plates receive 4 module rack and panel plugs or free plugs version. No accessory can be mounted on the rear of light weight multi-receptacle housings version.

VERSION	1044	0964	0804	0644	0484	0324	0244	0164
A (mm)	232.2	216.2	184.2	152.2	120.2	68.6	52.6	36.6
Number of rows	13	12	10	8	6	4	3	2

FREE PLUGS

DMC-M 80-01

4 Module Version

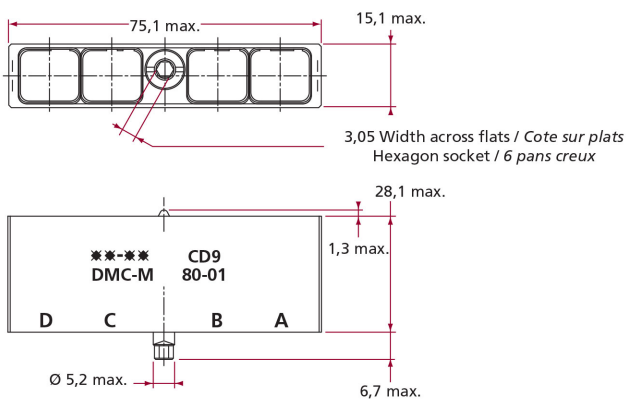

DMC-M 40-01

2 Module Version

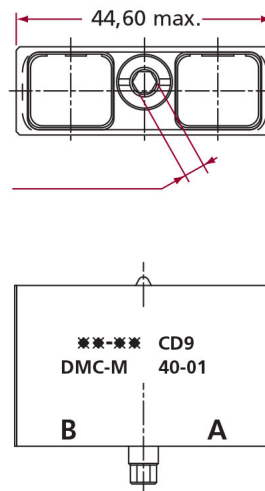

The receptacle/plug coupling is done with the tool part number 057-0592-80 or a standard allen key (coupling torque 0.1±0.03 daN.m).

RACK & PANEL PLUGS

DMC-M 88-01
4 Module Version*

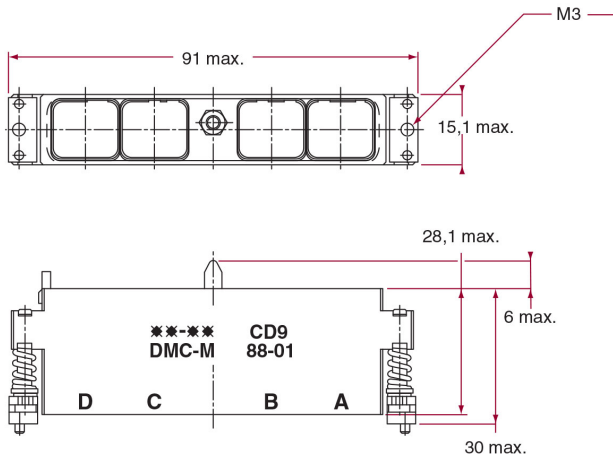

DMC-M 48-01
2 Module Version*

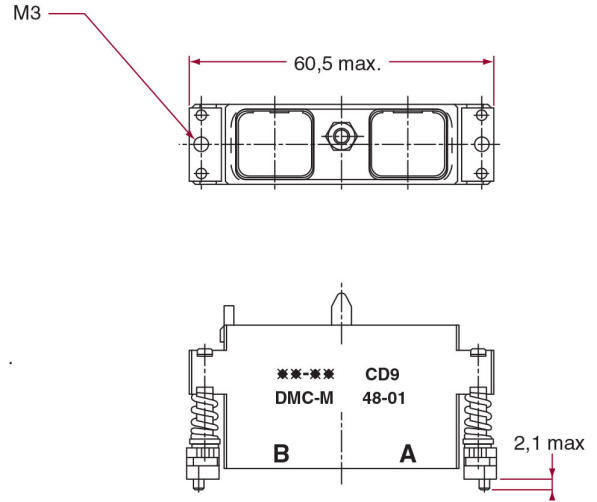

REVERSED RACK & PANEL PLUGS

DMC-M 89-01
4 Module Version*

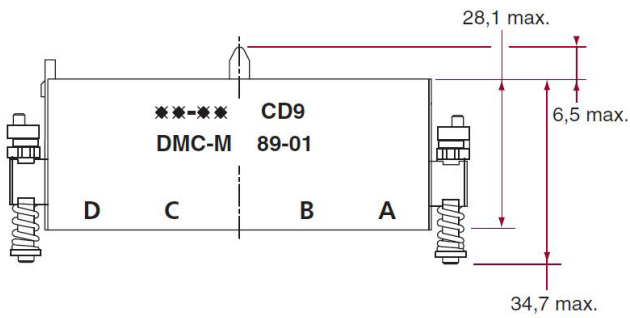

DMC-M 49-01
2 Module Version*

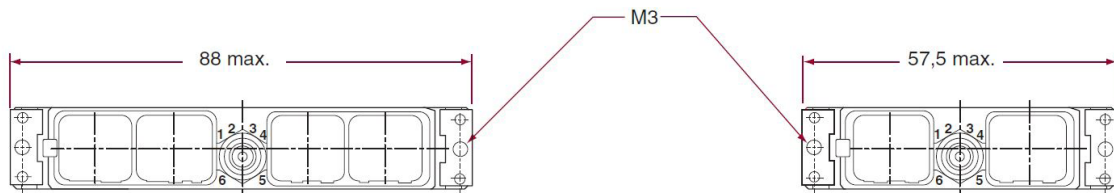
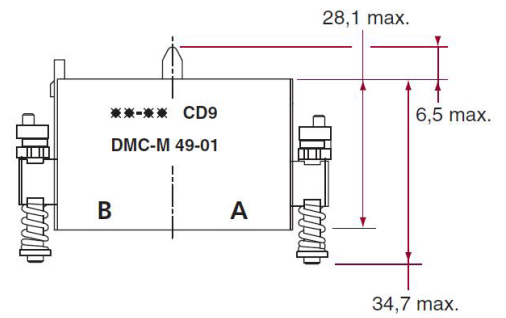

*Panel cut out, → See page 157.

MODULES

MALE MODULE

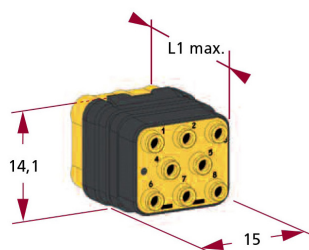

SIZES	L1 MAX. MM
22 to 12	16.46
8	18.70

FEMALE MODULE

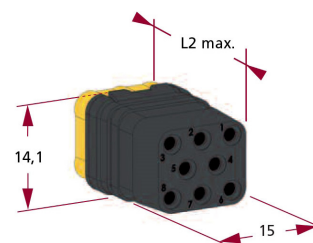

SIZES	L2 MAX. MM
22 to 12	22.40
8	33.20

Module extraction is done with the tool part number 057-0289-00 A or B. The module insertion in the housing (plug or receptacle) is done manually.

KEY POLARIZATION

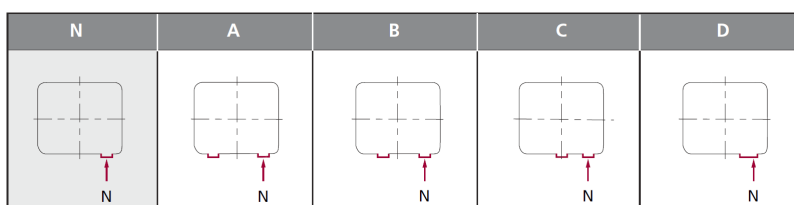

Module view from front face

Each module can have a specific polarization key **A**, **B**, **C** or **D**.
The polarized modules must be installed in their respective **A**, **B**, **C** or **D** housing cavities.

The modules with standard polarization N can be installed in all keyway options.

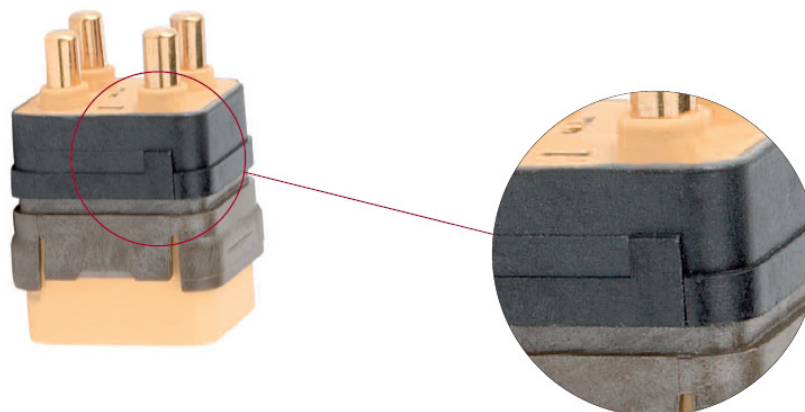

PANEL CUTOUTS FOR RACK AND PANEL PLUGS

TYPE 88, 89

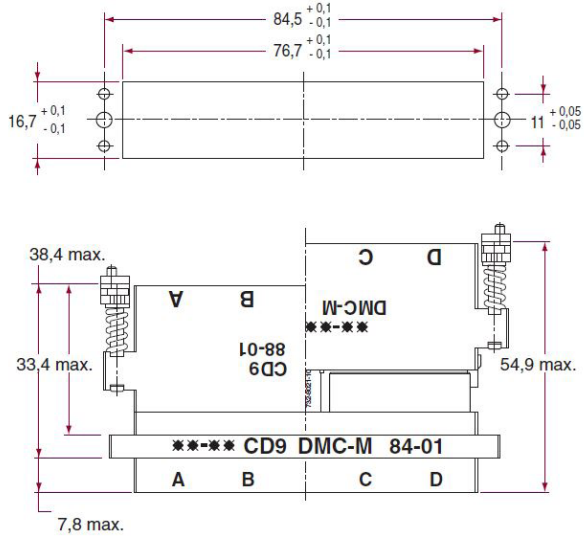

TYPE 48, 49

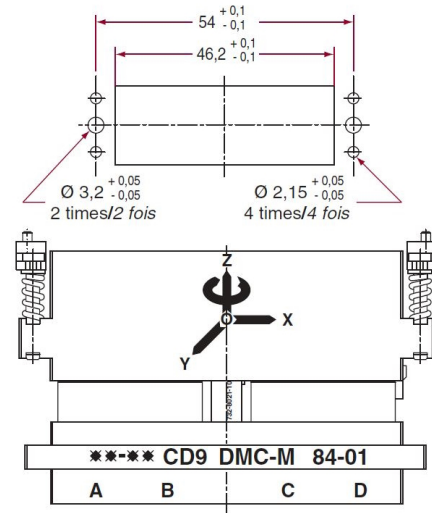

DMC-M 88, 89 with receptacle housing 82, 83, 84, 85
 DMC-M 48, 89 with receptacle housing 42, 43, 44, 45

Misalignment max between.
 Rack and Panel to receptacle housing.
 OZ : ± 2 mm
 OY : ± 0.75 mm
 OX : ± 0.75 mm
 θ : ± 1°

PANEL CUTOUTS FOR RECEPTACLE HOUSINGS

TYPE 82, 83, 84, 85

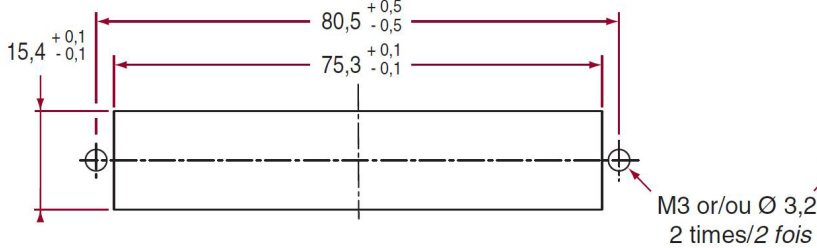

TYPE 42, 43, 44, 45

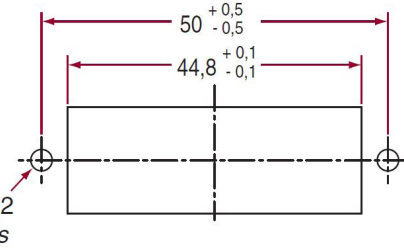

Coupling torque for panel screw 0.2 daN.m max.

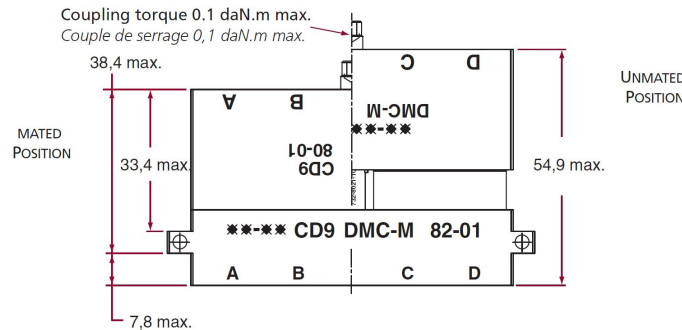

DMC-M 80 with receptacle housing 82, 83, 84, 85
 DMC-M 40 with receptacle housing 42, 43, 44, 45
NOTE: Multi-receptacle housing panel cut out contact us.

SHIELDED ACCESSORY BODIES

732-8054-10 A
4 Module Version

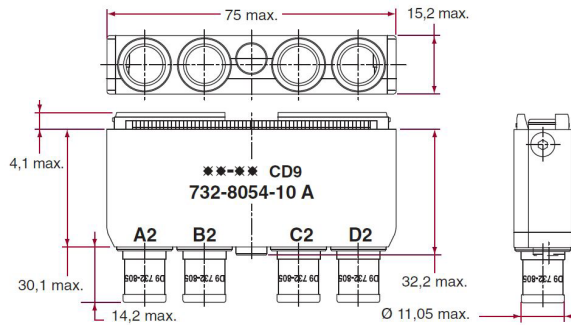

732-8054-14 A
2 Module Version

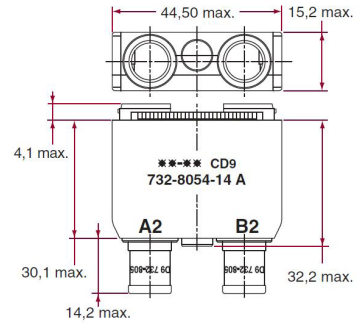

NON SHIELDED CABLE CLAMPS

732-8002-00
4 Module Version

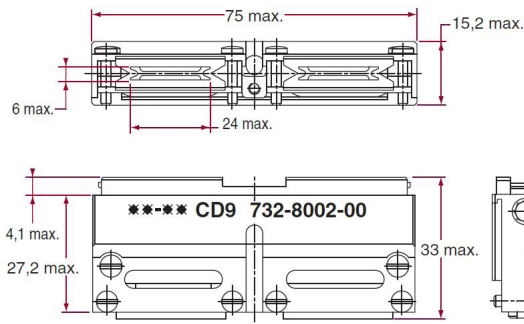

732-8002-01
2 Module Version

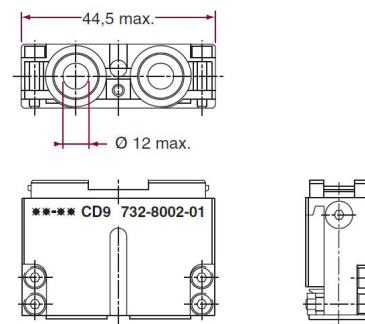

FLIGHT PROTECTION CAPS

732-8075-00
EN4165F3B

Shielded Cap for 4 Module Receptacle Housings

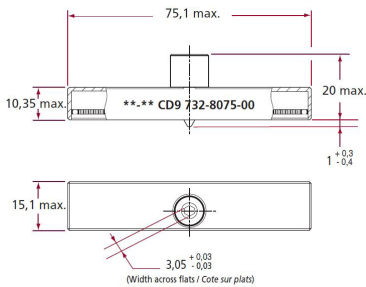

732-8075-01
EN4165F3A

Shielded Cap for 2 Module Receptacle Housings

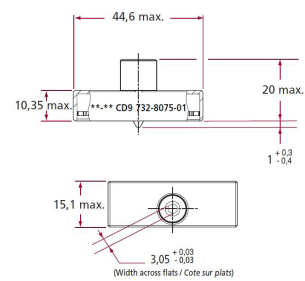

732-8258-00

Sealed Cap for 4 Module Receptacle Housings

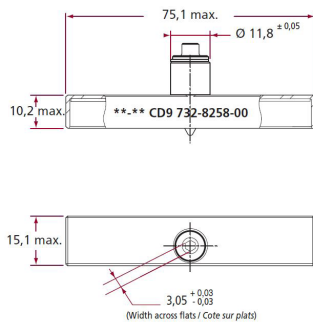

732-8239-01

Captive Sealed Cap for 4 Module Receptacle Housings

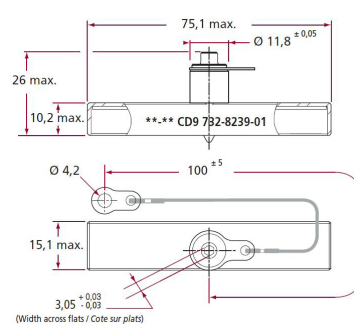

CONTACT CRIMPING



STEP 1: Use a crimping tool with the appropriate pilot stop.



STEP 2: Strip the copper wire over* 5 mm maximum.



STEP 3: Insert the contact in the crimping tool.



STEP 4: Insert the wire in the contact.



STEP 5: Tighten the crimping tool.



STEP 6: Inspect the contact. It must have 8 markings, and the wire must be seen in the contact side hole.

*For aluminum wire, contact us.

Note: For the use of a shielded version, do not forget to slide the cables in the chimney before crimping the contacts.

CONTACT INSERTION / EXTRACTION



STEP 1: Use the appropriate plastic tool. There is one tool for each contact size.

TOOLS PART NUMBERS	CONTACTS SIZE
M81969/14-01	22
M15570-20	20
M15570-16	16
M15570-12	12
114-008 or M81969/14-06	8

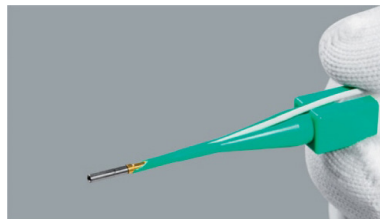

STEP 2: Insert the wire in the slot of the colored side of tool. Pull the wire until the contact butts against the tool.

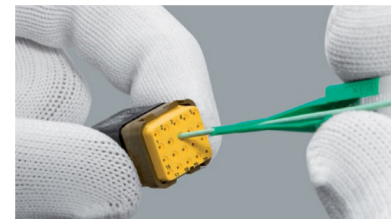

STEP 3: Insert the contact in the corresponding module cavity. Push the contact fully home. Then remove the tool and lightly pull the wire back to make sure that the contact is well inserted.



STEP 4: For extraction, insert the wire in the slot of the white side of the tool. Slide the tool into the cavity and push fully home until it is butted against the contact shoulder.



STEP 5: Press the wire between the fingers and the tool. Then pull the overall wire and tool back.

MODULE INSERTION / EXTRACTION

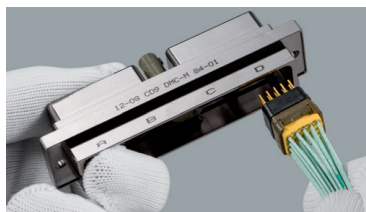

STEP 1: The module must be inserted from the rear side of the housing. The module polarization key must be visible from the marked side of the housing.



STEP 2: Push manually the module (wired or not) until butting. For sealed modules use the insertion tool part number 057-0699-00 A or B. Make sure that the module is well inserted either by pulling back the wires (if wired) or by pushing the module from the front of the housing

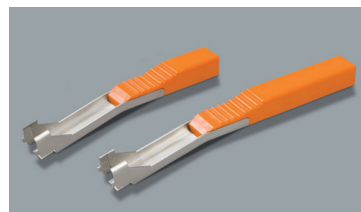

STEP 3: For extraction use the tool part number 057-0289-00 A or B.

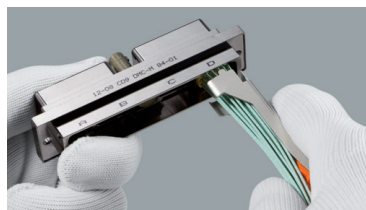

STEP 4: Slide the tool around the cable. Then push the tool inside the housing until butting.

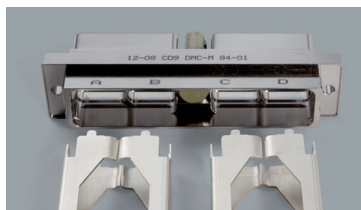

STEP 5: Note the different tool's position depending on the A, B, C or D cavities.



STEP 6: Press the cable between the tool and the fingers and pull the overall back. If the module is not wired, use the same tool, but push the module from the front of the housing.

RECEPTACLE KEYING COMPONENT MOUNTING



STEP 1: The receptacle keying component must be inserted by the rear side of the receptacle housing. Choose the orientation 1, 2, 3, 4, 5 or 6 by 60° rotation. Orientation is indicated by the largest keyway.



STEP 2: Insert the nut from the front of the receptacle housing.



STEP 3: For mounting and dismounting, use the tool part number 057-0590-80.



STEP 4: Tighten the nut with the tool, by applying a 0.15 ± 0.02 daN.m coupling torque.

PLUG KEYING COMPONENT MOUNTING

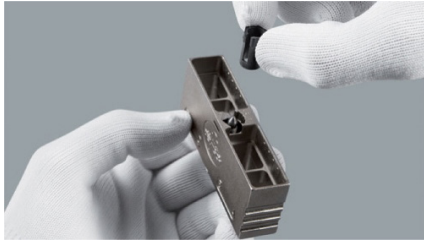

STEP 1: Use the plug keying component corresponding to the receptacle keying component (same color code). Choose the orientation 1, 2, 3, 4, 5 or 6 by 60° rotation. Orientation is indicated by the largest keyway.

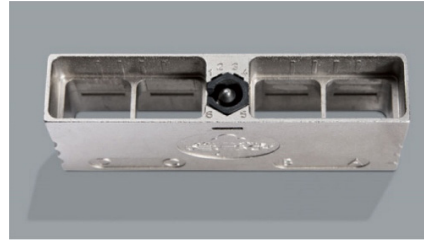

STEP 2: Insert the plug keying component in the front side of the plug housing. Make sure that the orientation allows the insertion of the receptacle keying component. Then fix the plug keying component manually by pushing it down to the bottom of its cavity.

FREE PLUG / RECEPTACLE COUPLING

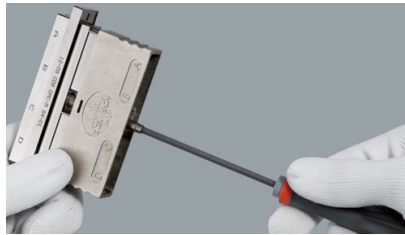

STEP 1: Use the tool part number 057-0592-80 or a standard allen key and apply a 0.1 ± 0.03 daN.m coupling torque.

SHIELDED BRAID MOUNT ON CHIMNEY



STEP 1: Slide the chimney and the shielded braid around the cable.

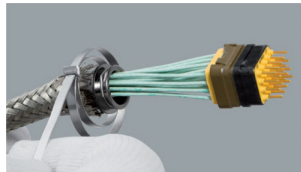

STEP 2: Slide the shielded braid and the 3 mm "band it" ring over the chimney.



STEP 3: Use the tool part number 057-0450-00 to tighten the ring around the shielded braid over the chimney.

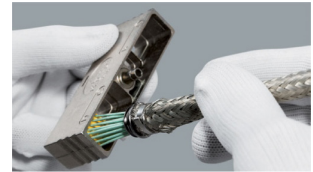

STEP 4: Clip the module in the housing.

SHIELDED ACCESSORIES

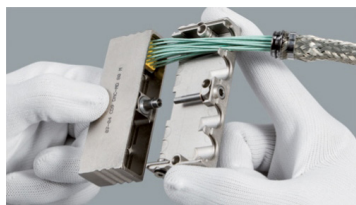

STEP 1: Choose the appropriate plug or receptacle accessory. Insert the accessory in the housing. Make sure that the marking of the accessory is in front of the respective housing's cavities.

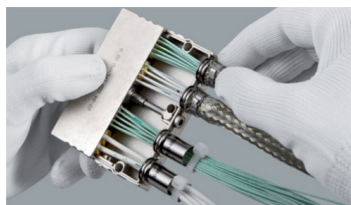

STEP 2: Insert the chimneys in their respective cavities.



STEP 3: Fit the accessory cover, and tighten the overall screws by applying a $0.05^{+0.02}$ daN.m coupling torque with a standard allen key.

TOOLING ASSEMBLY

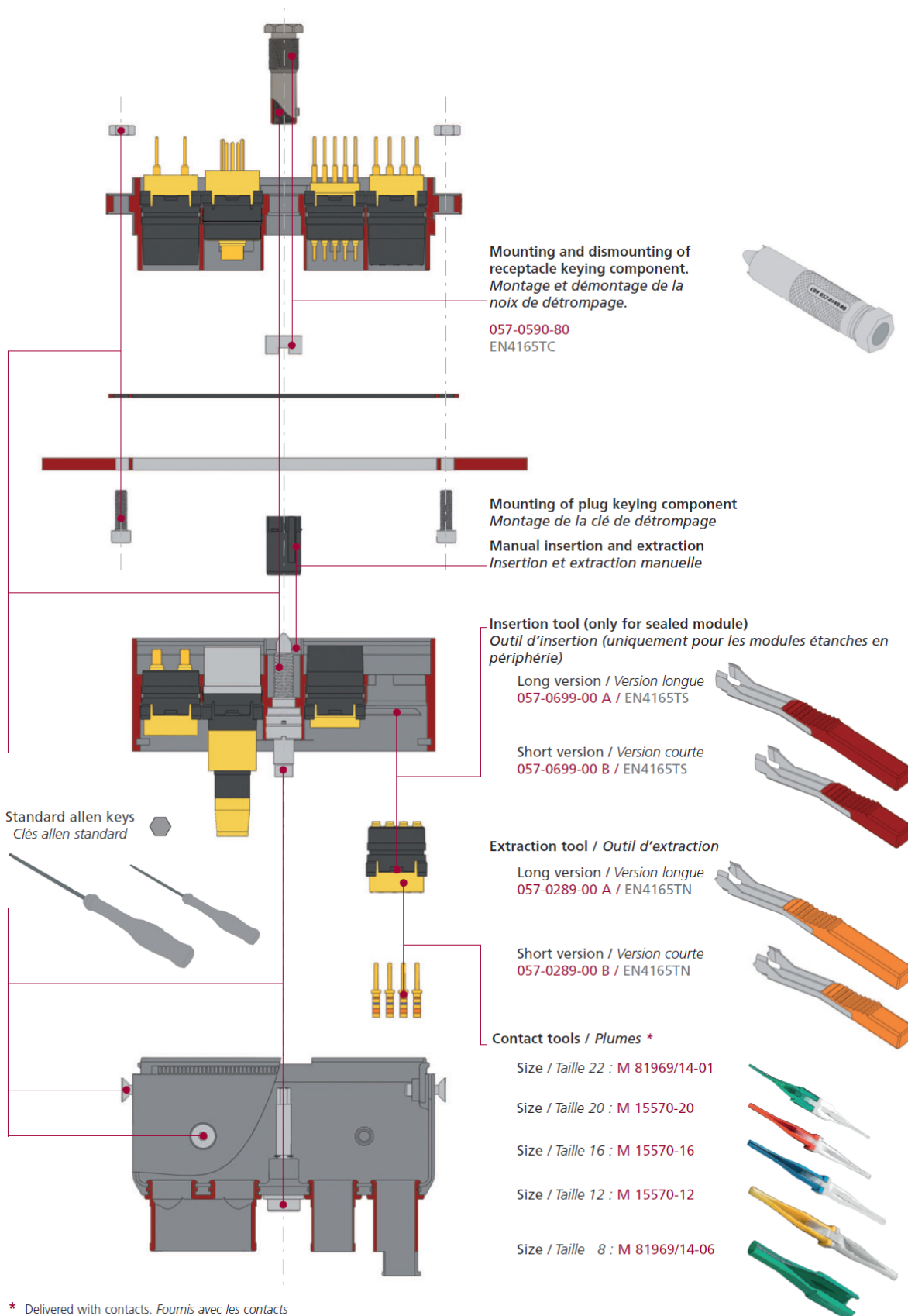

TE Connectivity DEUTSCH Contacts

M29600 & M39029 Series



WIDE RANGE OF ELECTRICAL CONTACTS

TE DEUTSCH contacts – M29600 & M39029 series are used in a variety of military and commercial applications. These TE DEUTSCH electrical contacts are designed to meet MIL-C-39029 or MIL-C-29600 standards and can transfer power and/or signal. For full product details on TE DEUTSCH contacts – M29600 & M39029 series, please see the specifications below.

APPLICATIONS

- Electronic box
- Space & aerospace applications
- Military applications
- Industrial applications

FEATURES

- Signal or power transfer
- Data buss
- Mil-spec / ASN Standard

SELECT PART NUMBER

SPECIFICATION P/N	TE DEUTSCH P/N	BIN CODE		
M29600/23-606	12343-23	BLUE	BLACK	BLUE
M29600/23-607	12343-20	BLUE	BLACK	VIOLET
M29600/23-608	12343-16	BLUE	BLACK	GRAY
M29600/24-610	12341-23	BLUE	BROWN	BLACK
M29600/24-611	12341-20	BLUE	BROWN	BROWN
M29600/24-612	12341-16	BLUE	BROWN	RED
M39029/1-100	2560-214-1631*(L)	BROWN	BLACK	BLACK
M39029/1-101	2560-215-1631*(L)	BROWN	BLACK	BROWN
M39029/1-102	2560-216-1431*(L)	BROWN	BLACK	RED
M39029/1-103	2560-217-1231*(L)	BROWN	BLACK	ORANGE
M39029/1-507	2560-218-2031*(L)	GREEN	BLACK	VIOLET
M39029/4-110	0641-1-2031*(L)	BROWN	BROWN	BLACK
M39029/4-111	0641-2-1631*(L)	BROWN	BROWN	BROWN
M39029/4-112	109026-31	BROWN	BROWN	RED
M39029/4-113	0641-3-1231*(L)	BROWN	BROWN	ORANGE
M39029/4-114	109028-31*(L)	BROWN	BROWN	YELLOW
M39029/5-115	100503*(L)	BROWN	BROWN	GREEN
M39029/5-116	100504*(L)	BROWN	BROWN	BLUE
M39029/5-117	109027*(L)	BROWN	BROWN	VIOLET
M39029/5-118	100505*(L)	BROWN	BROWN	GRAY
M39029/5-119	109029*(L)	BROWN	BROWN	WHITE
M39029/10-521	7362-255-1601	GREEN	RED	BROWN
M39029/10-522	7362-226-1601	GREEN	RED	RED
M39029/11-144	2560-212-2231	BROWN	YELLOW	YELLOW
M39029/11-145	2560-212-2031*(L)	BROWN	YELLOW	GREEN
M39029/12-148	2562-209-2231*(L)	BROWN	YELLOW	GRAY
M39029/12-149	2562-209-2031*(L)	BROWN	YELLOW	WHITE
M39029/16-166	81542-238*(L)	BROWN	BLUE	BLUE
M39029/16-167	81542-23*(L)	BROWN	BLUE	VIOLET
M39029/16-168	81542-20*(L)	BROWN	BLUE	GRAY
M39029/16-169	81542-16*(L)	BROWN	BLUE	WHITE
M39029/16-170	81542-12*(L)	BROWN	VIOLET	BLACK
M39029/17-171	81543-238*(L)	BROWN	VIOLET	BROWN
M39029/17-172	81543-23*(L)	BROWN	VIOLET	RED
M39029/17-173	81543-20*(L)	BROWN	VIOLET	ORANGE
M39029/17-174	81543-16*(L)	BROWN	VIOLET	YELLOW
M39029/17-175	81543-12*(L)	BROWN	VIOLET	GREEN
M39029/18-176	81541-238*(L)	BROWN	VIOLET	BLUE
M39029/18-177	81541-23*(L)	BROWN	VIOLET	VIOLET
M39029/18-178	81541-20*(L)	BROWN	VIOLET	GRAY
M39029/18-179	81541-16*(L)	BROWN	VIOLET	WHITE
M39029/18-180	81541-12*(L)	BROWN	GRAY	BLACK
M39029/22-191	CTS-S22/22*(L)	BROWN	WHITE	BROWN
M39029/22-192	CTS-S20/20*(L)	BROWN	WHITE	RED
M39029/22-193	CTS-S16/16*(L)	BROWN	WHITE	ORANGE
M39029/22-605	CTS-S12/12*(L)	BLUE	BLACK	GREEN
M39029/28-211	6162-233-1277 (AU/NI)	RED	BROWN	BROWN
M39029/28-409	6162-234-1277 (AU/NI)	YELLOW	BLACK	WHITE
M39029/28-410	6162-235-1277 (AU/NI)	YELLOW	BROWN	BLACK
M39029/28-411	6162-236-1277 (AU/NI)	YELLOW	BROWN	BROWN
M39029/28-413 61	62-238-1277 (AU/NI)	YELLOW	BROWN	ORANGE
M39029/28-414	6162-239-1277 (AU/NI)	YELLOW	BROWN	YELLOW
M39029/28-415	6162-240-1277 (AU/NI)	YELLOW	BROWN	GREEN

*Various platings available, contact us.

SELECT PART NUMBER

SPECIFICATION P/N	TE DEUTSCH P/N	BIN CODE		
M39029/29-212	0660-206-1631*(L)	RED	BROWN	RED
M39029/29-213	0660-206-1282 (SILVER)	RED	BROWN	ORANGE
M39029/29-214	0660-206-08*	RED	BROWN	YELLOW
M39029/29-215	0660-206-04*	RED	BROWN	GREEN
M39029/29-216	0660-206-00*	RED	BROWN	BLUE
M39029/30-217	0662-212-1631*(L)	RED	BROWN	VIOLET
M39029/30-218	0662-207-1631*(L)	RED	BROWN	GRAY
M39029/30-219	0662-207-1282 (SILVER)	RED	BROWN	WHITE
M39029/30-220	0662-207-0882	RED	RED	BLACK
M39029/30-221	0662-207-0482	RED	RED	BROWN
M39029/30-222	0662-207-0082	RED	RED	RED
M39029/31-228	4160-203-1631*(L)	RED	RED	GRAY
M39029/31-229	4160-204-1631*(L)	RED	RED	WHITE
M39029/31-240	0004-058-100*(L)	RED	YELLOW	BLACK
M39029/31-241	CANCELED, REPLACED WITH /31-627	RED	YELLOW	BROWN
M39029/31-627	4160-202-2031*(L)	BLUE	YELLOW	VIOLET
M39029/32-247	4162-201-1631*(L)	RED	YELLOW	VIOLET
M39029/32-248	4162-202-1631*(L)	RED	YELLOW	GRAY
M39029/32-259	0007-008-100*(L)	RED	GREEN	WHITE
M39029/32-260	4109-207-2000*(L)	RED	BLUE	BLACK
M39029/56-348	38943-22*(L)	ORANGE	YELLOW	GRAY
M39029/56-351	38943-20*(L)	ORANGE	GREEN	BROWN
M39029/56-352	38943-16*(L)	ORANGE	GREEN	RED
M39029/56-353	38943-12*(L)	ORANGE	GREEN	ORANGE
M39029/57-354	38946-22*(L)	ORANGE	GREEN	YELLOW
M39029/57-357	38946-20*(L)	ORANGE	GREEN	VIOLET
M39029/57-358	38946-16*(L)	ORANGE	GREEN	GRAY
M39029/57-359	38946-12*(L)	ORANGE	GREEN	WHITE
M39029/58-360	38941-22	ORANGE	BLUE	BLACK
M39029/58-363	38941-20*(L)	ORANGE	BLUE	ORANGE
M39029/58-364	38941-16*(L)	ORANGE	BLUE	YELLOW
M39029/58-365	38941-12*(L)	ORANGE	BLUE	GREEN
M39029/63-368	2562-201-2031*(L)	ORANGE	BLUE	GRAY
M39029/64-369	2560-201-2031*(L)	ORANGE	BLUE	WHITE
M39029/75-416	6162-217-1277 (AU/NI)	YELLOW	BROWN	BLUE
M39029/75-417	6162-218-1277 (AU/NI)	YELLOW	BROWN	VIOLET
M39029/75-418	6162-219-1277 (AU/NI)	YELLOW	BROWN	GRAY
M39029/75-419	6162-220-1277 (AU/NI)	YELLOW	BROWN	WHITE
M39029/75-421	6162-222-1277 (AU/NI)	YELLOW	RED	BROWN
M39029/75-422	6162-223-1277 (AU/NI)	YELLOW	RED	RED
M39029/75-423	6162-224-1277 (AU/NI)	YELLOW	RED	ORANGE
M39029/76-424	6162-229-1677 (AU/NI)	YELLOW	RED	YELLOW
M39029/76-425	6162-230-1677 (AU/NI)	YELLOW	RED	GREEN
M39029/76-426	6162-231-1677 (AU/NI)	YELLOW	RED	BLUE
M39029/76-427	6162-232-1677 (AU/NI)	YELLOW	RED	VIOLET
M39029/77-428	6162-213-1677 (AU/NI)	YELLOW	RED	GRAY
M39029/77-429	6162-214-1677 (AU/NI)	YELLOW	RED	WHITE
M39029/77-430	6162-215-1677 (AU/NI)	YELLOW	ORANGE	BLACK
M39029/77-431	6162-216-1677 (AU/NI)	YELLOW	ORANGE	BROWN
M39029/78-432	6162-253-1677 (AU/NI)	YELLOW	ORANGE	RED
M39029/78-433	6162-254-1677 (AU/NI)	YELLOW	ORANGE	ORANGE
M39029/78-434	6162-255-1677 (AU/NI)	YELLOW	ORANGE	YELLOW
M39029/78-435	6162-256-1677	YELLOW	ORANGE	GREEN

*Various platings available, contact us.

SELECT PART NUMBER

SPECIFICATION P/N	DEUTSCH P/N	BIN CODE		
M39029/83-450	2560-221-2031*(L)	YELLOW	GREEN	BLACK
M39029/83-451	2560-222-2031*(L)	YELLOW	GREEN	BROWN
M39029/83-508	2560-220-2031*(L)	GREEN	BLACK	GRAY
M39029/84-452	2562-214-2031*(L)	YELLOW	GREEN	RED
M39029/84-453	2562-215-2031*(L)	YELLOW	GREEN	ORANGE
M39029/84-509	2562-213-2031*(L)	GREEN	BLACK	WHITE
M39029/90-529	6162-283-0877	GREEN	RED	WHITE
M39029/91-530	6162-284-0877	GREEN	ORANGE	BLACK
M39029/101-553	1662-213-2031*(L)	GREEN	GREEN	ORANGE
M39029/101-554	1662-213-1631*(L)	GREEN	GREEN	YELLOW
M39029/102-558	6162-324-1231	GREEN	GREEN	GRAY
M39029/103-559	6162-325-1231	GREEN	GREEN	WHITE
M39029/106-614	12333-22*(L)	BLUE	BROWN	YELLOW
M39029/106-615	12333-20*(L)	BLUE	BROWN	GREEN
M39029/106-616	12333-16*(L)	BLUE	BROWN	BLUE
M39029/106-617	12333-12*(L)	BLUE	BROWN	VIOLET
M39029/107-620	12331-22	BLUE	RED	BLACK
M39029/107-621	12331-20*(L)	BLUE	RED	BROWN
M39029/107-622	12331-16*(L)	BLUE	RED	RED
M39029/107-623	12331-12*(L)	BLUE	RED	ORANGE
02003-926 (DSCC PART NUMBER)	6162-328-1277 (AU/NI)	WHITE	RED	BLUE
02004-936 (DSCC PART NUMBER)	6162-330-1277 (AU/NI)	WHITE	ORANGE	BLUE
M55302/65-02	2562-236-2231	N/A	N/A	N/A

*Various platings available, contact us.

SEALING SCREWS

Sealing screws are designed with a groove underneath the head to accommodate an O-ring. When tightened, the O-ring is compressed against the connector flange a seal against air, water, and gas. These screws are also vibration-resistant. The reservoir beneath

the head confines the O-ring and permits full metal-to-metal contact between the screw and the connector flange. Sealing screws can be reused without spoiling the sealing action. Sealing screws are used in conjunction with the nut plates below.

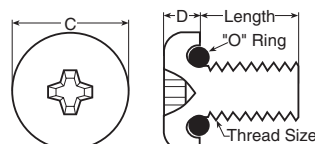
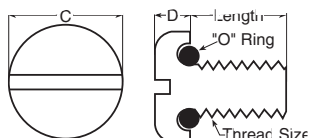

SLOTTED PAN HEAD						
PART NUMBER	THREAD	LENGTH	C MAX.	D MAX.	CLEAR HOLE	
					MIN.	MAX.
S-440-3/8	4-40NC-2A	3/8"	.220"	.069"	.125"	.129"
S-440-1/2		1/2"				
S-440-5/8		5/8"				
S-440-3/4		3/4"				
S-632-3/8	6-32NC-2A	3/8"	.271"	.083"	.147"	.152"
S-632-1/2		1/2"				
S-632-5/8		5/8"				
S-632-3/4		3/4"				
Metric						
SM4-12mm	M4	12mm	Contact us for details.			
SM5-12mm	M5	12mm				

PHILLIPS PAN HEAD (MEETS MS3212 & MS32131)						
PART NUMBER	THREAD	LENGTH	C MAX.	D MAX.	CLEAR HOLE	
					MIN.	MAX.
R-440-3/8	4-40NC-2A	3/8"	.238"	.080"	.125"	.129"
R-440-1/2		1/2"				
R-440-5/8		5/8"				
R-440-3/4		3/4"				
R-632-3/8	6-32NC-2A	3/8"	.294"	.097"	.147"	.152"
R-632-1/2		1/2"				
R-632-5/8		5/8"				
R-632-3/4		3/4"				

Material: Passivated stainless steel screws & silicone rubber O-rings

Additional threads, lengths, and styles available. Contact us for ordering information.

NUT PLATES

Nut plates are flat metal brackets containing four captive nuts that are used to mount flanged receptacles to a panel. They eliminate the challenge of working with loose nuts in a confined area and effectively distribute the screw tension across the back of the panel. These cost-effective devices are "self-wrenching," drawing

the bracket up for automatic alignment. Our plates are a "C" shape, design which allows you to slip the nut plate over the wire bundle just prior to mounting. The bracket is aluminum alloy with alodine plating and the nuts are steel alloy-plated with cadmium. Nut plates mate with above sealing screws.

CONNECTOR STYLES		MIL-DTL-26482		MIL-DTL-38999	
PART NUMBER	THREAD	AFD 50, MS3470	AFD 58, MS3472	DJT SERIES I	DTS/ACT SERIES III D38999/20
M85049/95-8A	4-40	8	-	-	-
M85049/95-10A	4-40	10	-	9	A/9
M85049/95-10B	6-32	-	10	-	-
M85049/95-12A	4-40	12	10	11	B/11
M85049/95-12B	6-32	-	12	-	-
M85049/95-14A	4-40	14	-	13	C/13
M85049/95-14B	6-32	-	14	-	-
M85049/95-16A	4-40	16	-	15	D/15
M85049/95-16B	6-32	-	16	-	-
M85049/95-18A	4-40	18	-	17	E/17
M85049/95-18B	6-32	-	18	-	-
M85049/95-20A	4-40	20	-	19	F/19
M85049/95-20B	6-32	-	20	-	-
M85049/95-22A	4-40	22	-	21	G/21
M85049/95-22B	6-32	-	22	-	-
M85049/95-24A	6-32	-	24	25	J/25
M85049/95-24B	6-32	24	-	23	H/23
M85049/95-25A	6-32	-	-	25	-

*plastic bracket

+ PCD contacts for high density contact arrangement, MA class only, special.

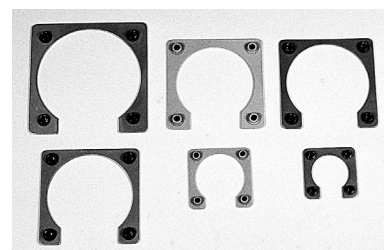

TORQUE	MAX.	
	IN/LB	MM
4-40	6.3	.71
6-32	10	1.12

STANDARD HEAT SHRINK BOOTS

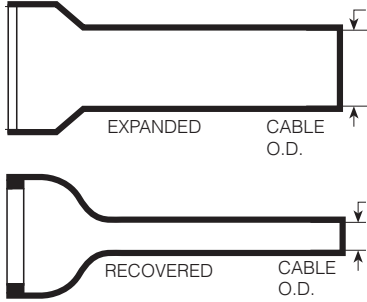

Standard heat shrink boots are supplied in flame-retardant polyolefin with an adhesive inner liner. A high shrink-ratio version for sealing smaller wire bundles is also available. The adhesive liner is heat-activated and bonds to the underlying surface, filling any small voids that might exist. When cool, the adhesive forms a barrier against water, moisture, dirt and other environmental contaminants. The lip on the connector end of the recovered boot fits into the sealing groove. Operating temperature is -67° F to 275° F (-55° C to 135° C). These boots are also available in halogen-free polyolefin, semi-rigid polyolefin, silicone, or Viton, with or without adhesive liner.

HEAT SHRINK BOOT PART NUMBER	CABLE O.D.		± 10%	AFD M85049/60 (MIL-DTL-26482 STYLE) SHELL SIZE LENGTH									DJT M85049/62 & DTS/ACT M85049/69 (MIL-DTL-38999 STYLE) SHELL SIZE								
				8	10	12	14	16	18	20	22	24	A	B	C	D	E	F	G	H	J
	MAX.	MIN.		9	11	13	15	17	19	21	23	25									
HSB1	0.25 (6.4)	0.08 (2.0)	2.37 (60.2)	•	•								•	•							
HSB2	0.30 (7.6)	0.10 (2.5)	2.92 (74.2)			•	•	•							•	•	•				
HSB3	0.38 (9.7)	0.12 (3.0)	3.32 (84.3)						•	•							•	•			
HSB4	0.45 (11.4)	0.14 (3.6)	3.92 (99.6)								•	•							•	•	
SB1	0.88 (22.4)	0.25 (6.4)	4.17 (105.9)	•	•	•	•						•	•	•	•					
SB2	1.01 (25.7)	0.29 (7.4)	4.77 (121.2)		•	•	•	•						•	•	•	•				
SB3	1.16 (29.5)	0.33 (8.4)	5.46 (138.7)			•	•	•	•						•	•	•	•			
SB4	1.34 (34.0)	0.39 (9.9)	6.28 (159.5)					•	•	•						•	•	•			
SB5	1.47 (37.3)	0.41 (10.4)	7.00 (177.8)							•	•	•					•	•	•		
SB6	1.72 (43.7)	0.48 (11.2)	8.00 (203.2)								•	•							•	•	

All dimensions in inches (millimeters in parenthesis)

RIGHT ANGLE HEAT SHRINK BOOTS

RECOVERED RSB and RHSB

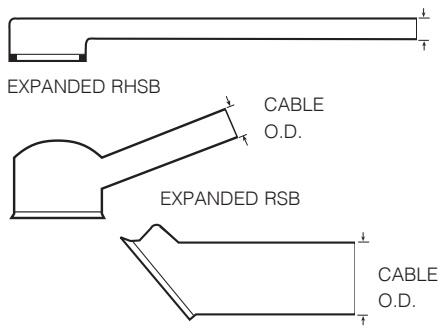

Right angle heat shrink boots are supplied in flame-retardant polyolefin with an adhesive inner liner. A high shrink-ratio version for sealing smaller wire bundles is also available. The adhesive liner is heat-activated and bonds to the underlying surface, filling any small voids that might exist. When cool, the adhesive forms a barrier against water, moisture, dirt and other environmental contaminants. The lip on the connector end of the recovered boot fits into the sealing groove. Operating temperature is -67° F to 275° F (-55° C to 135° C). These boots are also available in halogen-free polyolefin, semi-rigid polyolefin, silicone, or Viton, with or without adhesive liner.

HEAT SHRINK BOOT PART NUMBER	CABLE O.D.		LENGTH ± 10%	AFD M85049/60 (MIL-DTL-26482 STYLE) SHELL SIZE								DJT M85049/62 & DTS/ACT M85049/69 (MIL-DTL-38999 STYLE) SHELL SIZE									
	MAX.	MIN.		8	10	12	14	16	18	20	22	24	A 8/9	B 10/11	C 12/13	D 14/15	E 16/17	F 18/19	G 20/21	H 22/23	J 24/25
RHSB1	0.24 (6.1)	0.08 (2.0)	1.77 (45.0)	●	●								●	●							
RHSB2	0.30 (7.6)	0.10 (2.5)	2.64 (67.1)			●	●	●						●	●	●					
RHSB3	0.37 (9.4)	0.12 (3.0)	3.17 (81.0)						●	●							●	●			
RHSB4	0.45 (11.4)	0.14 (3.6)	4.57 (116.1)							●	●								●	●	
RSB1	0.88 (22.4)	0.23 (5.8)	4.14 (105.2)	●	●	●	●						●	●	●	●					
RSB2	1.01 (25.7)	0.26 (6.6)	4.88 (124.0)		●	●	●	●						●	●	●					
RSB3	1.16 (29.5)	0.30 (7.6)	5.76 (146.3)			●	●	●	●					●	●	●	●				
RSB4	1.34 (34.0)	0.35 (8.9)	6.78 (172.2)				●	●	●	●					●	●	●	●	●		
RSB5	1.47 (37.3)	0.37 (9.4)	7.29 (185.2)						●	●	●							●	●	●	
RSB6	1.72 (43.7)	0.44 (11.2)	7.93 (201.4)							●	●								●	●	

All dimensions in inches (millimeters in parenthesis)

POTTING SYSTEM



3M Scotch-Weld™ EPX potting systems consist of a self-leveling Duo-Pak epoxy potting compound cartridge, an EPX applicator, and an EPX nozzle for precise mixing. 3M's two-part epoxy potting compound is for use with the PT/PTSE and MS-E/F/R, AIT & AIB series "P" style endbells. The EPX system provides an easy way to meter, mix and dispense potting compound. 3M's non-corrosive epoxy potting compound is specially-formulated for electronic applications. Available in black and clear.

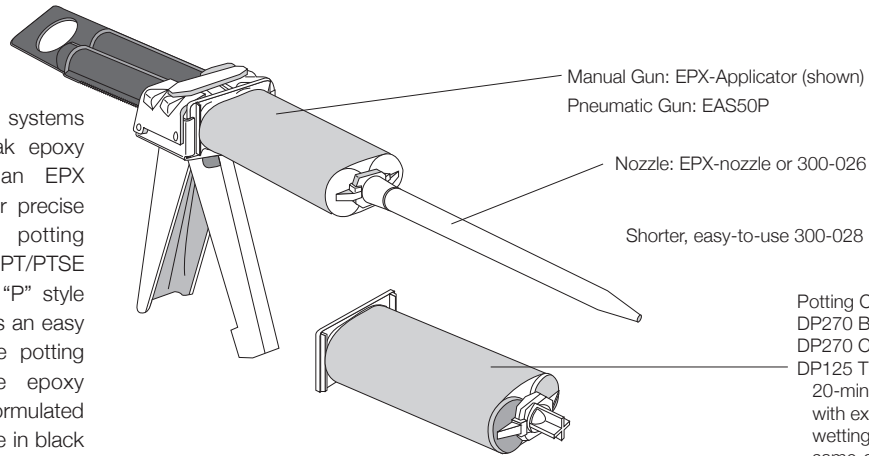

Potting Compound:
 DP270 BLACK
 DP270 CLEAR
 DP125 TRANSLUCENT
 20-minute work-life with excellent wetting properties allows same-day shipping of assemblies
 DP100 PLUS CLEAR
 4-minute work-life; Rapid setup for automotive applications

BLACK POLYOLEFIN CONVOLUTED BOOTS



Convoluted boots are used in applications that require various cable outlet angles or if the cable harness requires quick access to connector wiring. When held in place on an angle while cooling, these boots will maintain their bend. If maximum connector serviceability is required, a two-piece spin coupling endbell should be used. The convoluted boot is used in conjunction with this spin coupling endbell, which allows the user to unthread and push the endbell back out of the way by heating the boot until it becomes flexible. The user can make the required repair, reheat the boot and rethread the backshell without having to cut off and replace the boot.

CONVOLUTED BOOTS	CABLE O.D.		LENGTH	MAX 90° LENGTH	AFD M85049/60 (MIL-DTL-26482 STYLE) SHELL SIZE								DJT M85049/62 & DTS/ACT M85049/69 (MIL-DTL-38999 STYLE) SHELL SIZE									
	MAX.	MIN.			8	10	12	14	16	18	20	22	24	A	B	C	D	E	F	G	H	J
	(17.8)	(8.1)			(133.4)	(67.8)																
CSB2	0.70	0.32	5.25	2.67	●	●							●	●								
CSB3	1.06	0.50	5.75	2.89			●	●	●	●				●	●	●						
CSB4	1.44	0.69	6.25	3.08					●	●	●	●				●	●	●	●	●		
CSB5	1.80	0.88	6.75	3.26						●	●	●			●	●	●					

All dimensions in inches (millimeters in parenthesis)

HEAT GUN

The Panduit HSG115V500 heat gun is a general-purpose tool designed for all types of heat shrink boots and tubing. The air intake adjustment varies temperature from 500°F (260°C) to 650°F (344°C). The unit operates on 115 Vac at 11 amps. The tool comes with an adjustable stand and a neoprene AC cord. The bearings, brushes and heating element are replaceable.

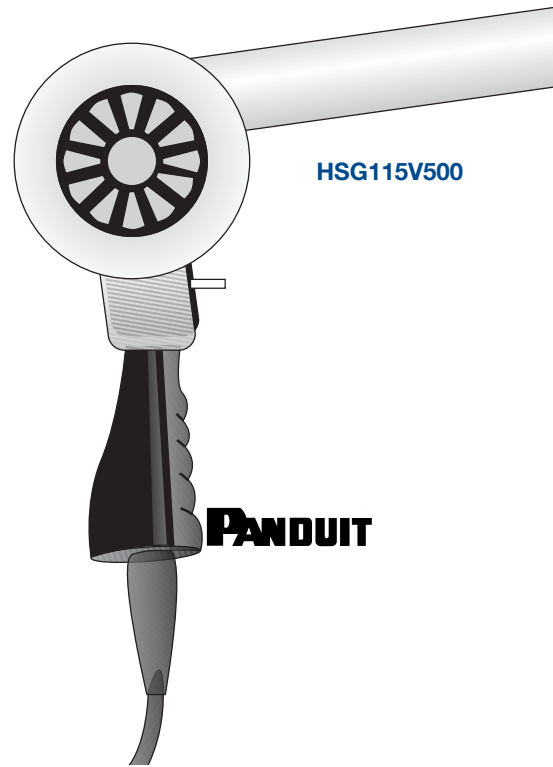

ACCELERATED AGING – A connector test in which temperature, voltage, current, or other parameters are increased beyond the normal operating values to observe deterioration in a relatively short period of time.

ACCESSORIES – Auxiliary devices such as cable clamps, endbells, gaskets, or any number of mechanical hardware devices that can be added to a connector.

ADAPTER – A device which enables the interconnection of two dissimilar connectors and/or mechanically allows the connection of unique accessories. Some adapters are actually connectors in themselves and allow the user to mate the adapter with one half of a connector and then mate a different type of connector to the adapter effecting a transition. These types of adapters are common in RF and audio connectors. Other adapters are purely mechanical and allow the use of unique accessories or allow for special mounting configurations.

AEM – A connector insulating material which will not emit halogen (toxic) gases when exposed to flame. Referred to as a ZERO HALOGEN insulator. See HALOGEN.

ALLOY – A composition of two or more elements, of which at least one is a metal. In connector applications it is usually a combination of metals which is used to create an alloy superior in performance to any of its individual components.

ALTERNATE INSERT POSITION – See ROTATION.

ALTERNATING CURRENT – A flow of electricity which reaches a maximum in one direction, decreases to zero, then reverses itself and reaches maximum in the opposite direction. This cycle is repeated continuously. The number of such cycles per second is the frequency. The average value of the voltage during any cycle is zero. Abbreviated ac.

AMBIENT TEMPERATURE – The temperature of the environment surrounding the connector. Usually the air. Normally used as the reference when specifying the **OPERATING TEMPERATURE** range of the connector.

AMP – Abbreviation for ampere.

AMPERE – A unit of electrical current or rate of flow of electrons. One volt across one ohm of resistance causes a current of 1 ampere.

ANODIZE – A protective, insulating oxide layer formed on a metal by electrolytic action. Occasionally used as the outer most layer in connector plating, anodize is a very tough, non-conductive plating.

APIN CONTACT – (See Pizza Bone)

ARC – A luminous discharge of electricity through a gas. In connector usage, this is an extremely undesirable discharge through the air across two or more contacts or the contacts and the shell. This is usually the result of operating the connector beyond its capabilities. Arc discharge is characterized by a relatively low voltage drop, a high current density, and the high probability that the connector and related circuitry will be damaged as a result.

ATMOSPHERE – The unit of pressure defined as the pressure of 760 mm mercury at 0o C. Approximately 14.7 pounds per square inch.

AWG – American Wire Gauge. A standard for wire diameters based on the approximate circular mil area of the wire. As numbers get larger, wire diameters decrease in size (a size 16 AWG wire has a larger diameter than a size 22 AWG).

BACK MOUNTING – See REAR MOUNTING.

BACK-END TERMINATION – See ENDBELL.

BACKSHELL MOLD – See POTTING CUP.

BAR – A centimeter-gram-second unit of pressure (force exerted on a unit of area) equal to 1,000,00 dynes per square centimeter. Formerly known as microbar. Its symbol is b.

BASE METAL – The metal which the connector or connector component is made and over which various platings will be deposited.

BAYONET COUPLING – A quick coupling mechanism for mechanically mating and unmating connector halves. The plug half has a coupling nut with internal ramps and the receptacle has three "bayonet" pins. The two halves are mated and unmated by rotating the coupling nut. A REVERSE BAYONET COUPLING reverses this arrangement, with the ramps on the receptacle and the bayonet pins or roller bolts under the coupling nut.

BERYLLIUM COPPER – An alloy of copper used to make contacts. It is relatively expensive, but has superior spring quantities, is resistant to fatigue, and can operate at higher temperatures than other materials such as phosphor bronze. It is used when numerous insertion and extraction cycles are required.

BEZEL – A holder or flange designed to receive and position a lens or window in an electronic component such as an indicator assembly.

BIFURCATED CONTACT – A contact design in which the metal of the mating tube is slotted lengthwise to create two independent spring elements.

BODY – The main portion of the connector made of the shell, insulator, and contacts.

BOOT – A rear accessory, usually made of a resilient material, which is used around a multiconductor cable to add additional insulation, strength, abrasion resistance, or sealing. Also see SHRINK BOOT.

BRAID – A woven metal tube used as shielding around a wire or a group of wires. In a flattened form, it is used as a grounding strap.

BRASS – metal alloy of copper and zinc used for contacts. It is low cost, an excellent conductor, and resists fatigue.

BREAKDOWN – An electrical discharge through a connector insulator or insulation on a wire. A catastrophic failure mode.

BREAKDOWN VOLTAGE – The voltage at which an insulator ruptures.

BREAKOUT – The point at which wires are separated from a multi-conductor cable or wire bundle for routing to other points.

BS – Prefix for a performance specification of the British Standards Institution. See BSI.

BSI – Abbreviation for British Standards Institution which deals with general, electrical, and telecommunication standards in Britain. BSI has a deliberate policy of republishing European standards in the English language as British standards. These usually bear the prefix BS EN. Specifications are based upon those of the CEN, CENELEC, ETSI, or international specifications of ISO, IEC, and ITU.

BUNDLE – See WIRE BUNDLE.

C – Abbreviation for centigrade, or more properly Celsius, since the term centigrade was officially abandoned by international agreement in 1948. See CELSIUS.

CABLE ASSEMBLY – A cable (or bundle of cables) with plugs and/or receptacles on each end.

CABLE CLAMP – A rear connector clamping accessory which tightens over a cable or wire bundle to provide strain relief to the cable. The cable clamp may be part of a more elaborate endbell or it may be used alone. Some cable clamps also provide cable jacket sealing using a resilient gland; for example the MS3057-C, others provide only strain relief.

CABLE CONNECTING RECEPTACLE – Unlike most receptacles which are designed for panel mounting, a cable connecting receptacle is for in-line use. It does not have a flange or jam nut for panel mounting, but does have rear threads to accept an endbell.

CABLE RECEPTACLE – See CABLE CONNECTING RECEPTACLE.

CABLE SEAL – An endbell or cable clamp that is used to seal a round jacketed cable as it enters the rear of the connector. Examples would be a Gland Seal Endbell or an MS3057-C cable clamp.

CABLE SEALING RANGE – See SEALING RANGE.

CADMIUM – A metallic element chemically related to zinc and mercury, widely used for plating. It has an extraordinary ability to resist outdoor corrosion. It is especially resistant to alkali. Cadmium is electrically conductive and it is easy to solder. It's symbol is Cd.

CANADIAN STANDARDS ASSOCIATION – In Canada, a body that issues standards and specifications prepared by various voluntary committees of government and industry. Abbreviated CSA.

CEC – Canadian Electric Code. Standards and requirements for installation and maintenance of electrical components in Canada.

CECC – Abbreviation for Electronic Components Committee of CENELEC, the European committee for Electrotechnical Standardization. CECC uses the IEC test methods, and thus is based upon worldwide standards.

CEN – Abbreviation for European Committee for Standardization. A European standards group corresponding to the ISO at the European level.

CENELEC – Abbreviation for European Committee for Electrical Standardization. A European standards group corresponding to the IEC at the European level.

CHAMFER – A bevel cut on the inside edge of an insulator contact cavity or a mounting hole. In a contact cavity the chamfer is intended to guide the mating pin into the cavity. In a mounting hole it is a countersink to accept a cone shaped bolt.

CIRCUIT – An electronic path between two or more points capable of carrying an electrical current.

CIRCULAR MIL – The international term used to define the cross-sectional area of a wire, equal to the area of a circle one mil (.001 inch) in diameter.

CIRCULAR MIL AREA – The square of the diameter of a round conductor measured in thousandths of an inch (.001).

CLEARANCE HOLE – A mounting hole without threads. Also known as a through hole.

CLOCKING – See INSULATOR ROTATION.

CLOSED CRIMP CONTACT – A mounting hole without threads. Also known as a through hole.

CLOSED ENTRY – An insulator design which limits the diameter of the mating contacts.

CLOSED SOCKET CONTACT – A socket contact in which the mating cavity limits the entry of a contact or probe having a diameter larger than the mating pin.

COEFFICIENT OF EXPANSION – The average expansion per degree of temperature over a specified range expressed as a fraction of the original dimension. The coefficient may be linear or volumetric.

COMPONENT – An essential functional part of the connector.

CONTACT – Conductive element in a connector which makes the actual connection between the wire and the mating connector for the purpose of transferring electrical energy. Ideally the contact should add nothing to the circuit. Contacts typically have a small **CONTACT RESISTANCE** and associated **POTENTIAL DROP**. Contacts come in many styles such as solder, crimp, printed circuit (PC), wire-wrap, first-make last-break, and thermocouple, to name just those found in this catalog. Also see **SOLDER CONTACT**, **CRIMP CONTACT**, **PC CONTACT**, **THERMO-COUPLE CONTACT**, **FIRST-MAKE LAST-BREAK CONTACT**, **WIRE WRAP CONTACT**, **STAMPED AND FORMED CONTACT**, **SCREW MACHINE CONTACT**, **PIN CONTACT**, and **SOCKET CONTACT**.

CONTACT ALIGNMENT – The overall play that a contact has in the insulator cavity to allow the mating contacts to self align. Also called contact float.

CONTACT ARRANGEMENT - See LAYOUT.

CONTACT CAVITY - A defined hole in the connector insulator into which the contacts fit. The cavities are generally marked with a unique designation or number for ease of identification.

CONTACT INSPECTION HOLE - See INSPECTION HOLE.

CONTACT RESISTANCE - The maximum amount of resistance which a contact introduces into the connection when carrying a specified current (usually stated in milliohms). When not stated, values are typically given for "Initial" or new contacts. Most specifications also limit the maximum resistance during or after each of a series of extreme tests, such as "Contact Resistance After Corrosion Test". These figures are typically slightly higher than "Initial". Also see **POTENTIAL DROP**.

CONTACT RETENTION - The maximum allowable axial load which can be applied to a contact from either direction without it being dislodged from the insulator. Usually stated in Newtons or pounds of force.

CONTACT SEPARATION FORCE - The force required to separate a pair of mated contacts. Usually stated in Newtons or pounds of force.

CONTACT SIZE - This usually relates to the maximum size wire this contact can nominally accommodate. It is based on that AWG size most closely corresponding to the circular mil area of the engaging end of a pin contact. For example, a size 16 contact can accommodate a size 16 AWG wire maximum and the pin corresponds to the CMA of a size 16 AWG. Note, however, that oversized crimp pots are available for some crimp contacts which will allow, for example, a size 16 contact to accommodate a size 14 AWG wire.

CONTACT SPACING - The distance between two centers of adjacent contacts.

CONTINUITY - An unbroken conductive path for electrical energy.

COUPLING - There are three common methods of mechanically coupling circular connectors, all three are represented in this catalog. Coupling can be made with threads (as in the CT series), three pin bayonet (as in TRIDENT and KPT/ KPSE) or ramps (as in the CB and CR series).

COUPLING NUT - The rotating ring on plug style connectors which mechanically locks the two connector halves together. Coupling nuts may function by means of internal threads, roller wheels, pins, or internal bayonet ramps. Also known as a coupling ring.

COUPLING RING - See COUPLING NUT.

COUPLING TORQUE - Torque is rotational force, usually stated in Newton-meters or Foot-pounds. In the coupling of connectors it is normally used to give the maximum or minimum force which should be applied to the coupling nut when mating and unmating the two connector halves.

CPS - Cycles per second.

CREEPAGE - The conduction of electricity across the surface of an insulator.

CREEPAGE DISTANCE - The shortest distance between contacts of opposite polarities, or between a live contact and ground, measured over the surface of the insulator.

CREEPAGE PATH - A path across the surface of the insulator between two conductors. Lengthening the path reduces the possibility of arc damage.

CRIMP - A method of attaching a contact to a wire through the application of pressure.

CRIMP CONTACT - A contact which is terminated to a wire by means of crimping with an appropriate die and tool. After termination, an insertion tool is normally used to insert the crimped contact into the connector. Removable crimp contacts can be FRONT RELEASE or REAR RELEASE. A removal tool is usually required to remove the contact.

CSA - Abbreviation for Canadian Standards Association.

CURRENT - The movement of electrons through a conductor. Current is measured in amperes. It's symbol is I.

CURRENT RATING - The maximum current that a particular wire, contact, or connector can accommodate. NOTE: When several wires are used in a single connector or elevated temperature or altitude is involved, derating curves must be applied to these ratings. A typical derating system is MIL-W-5088 which allows the user to calculate the derating effects of current, ambient temperature, number of wires in the bundle, and altitude.

DB - Abbreviation for DECIBEL.

DEAD FACE - See DEAD FRONT.

DEAD FRONT - The mating surface of a connector which is designed so that the conductive elements, such as the contacts, are physically recessed in the insulator to avoid shorting or shock hazard.

DECIBEL - A standard unit of measure for transmission gain or loss. It expresses the ratio of power input to power output. Abbreviated DB. The term DBm is used when 1 milliwatt is the reference level.

DERATING - To reduce the voltage, current, or power rating of a connector to improve its reliability or to permit operation at high ambient temperatures or altitudes.

DERATING CURVE - A graph of the change in power handling capability of a connector as a function of ambient temperature or altitude. Typically the graphed function is curved, hence the name.

DIALYL PHTHALATE - A thermosetting plastic used for insulators and some types of connector housings. It has outstanding resistance to chemicals, excellent dimensional

stability, and superior electrical insulating properties.

DIELECTRIC - An insulator used to isolate two conductors.

DIN - Abbreviation for DEUTSCHE Industrie Norm, a German standards organization.

DIRECT CURRENT - An essentially constant value of current that flows in only one direction. Abbreviated dc.

DRAIN WIRE - In a foil shielded cable, the drain wire is an uninsulated wire which runs the length of the cable making intimate electrical contact with the inside of the foil. Since it would be difficult to directly terminate the fragile foil shield, the drain wire is used to terminate the shield by either soldering or crimping the drain wire to a ground termination.

DUMMY RECEPTACLE - A receptacle shell which takes the place of a working receptacle and is used to fill an empty connector mounting hole or to provide a location to mate an unused connector. A dummy receptacle has no contacts and no insulator and thus provides no electrical function.

DUST CAP - A cover used in place of a mating connector to seal it against dirt and moisture. Usually secured to the connector by a captive chain, wire, or rope.

DYNE - The standard centimeter-gram-second unit of force, equal to the force that produces an acceleration of one centimeter per second per second on a mass of one gram. Its abbreviation is dyn.

ELECTROPLATING - To deposit a metal on the surface of a conductor using electrolysis.

EMI/RFI - Electro-Magnetic Interference and Radio Frequency Interference. This is unwanted stray electronic radiation which may enter, and/or be emitted by a electronic system. The most common method of shielding interconnections against this radiation is to use wires with a metallic braided shield and a connector system which will extend the shield through the interconnection. This type of design will keep radiation from entering, or being emitted by the system. Endbells for shielded cable and connectors with threads or grounding fingers are typically used for this purpose. Call for the specific EMI/RFI accommodations of the connectors in this catalog.

EN - Abbreviation for Euro Norm. A European market-wide product standard.

ENDBELL (also known as BACKSHELL) - The outer rear end of the connector which is attached by means of internal threads or screws. It adapts the connector to its wire connections in a variety of ways. Typical endbells might have cable clamps to secure a wire bundle, ridges for heat shrink tubing, pipe threads, or shield termination mechanisms. Endbells may be straight, right angle, or 45 degree.

ENVIRONMENTALLY SEALED - A connector which uses seals, gaskets, O-rings, potting, or other devices to prevent moisture, dirt, air, or other contaminants from entering and degrading its performance.

ETSI - Abbreviation for European Telecommunications Standards Institute. A group which deals with telecommunications standards at the European level, corresponding to the ITU at the international level.

EU - Abbreviation for European Union. A group of European community nations. In practice, they typically adopt standards set by the ISO, IEC, and ITU.

EX APPROVAL - Symbol to identify approval by the ATEX directive.

EXTRACTION TOOL - A device used to remove a (removable) contact from a connector insulator. The extraction tool may be inserted into the mating face of the insulator (FRONT RELEASE) or the wire side (REAR RELEASE). In either case, the contact comes out the rear, or wire side, of the connector.

F - Abbreviation for Fahrenheit.

FAHRENHEIT - A temperature scale in which the freezing point of water is defined as 32 degrees and the boiling point is 212 degrees at normal atmospheric pressure. See the conversion tables for converting Fahrenheit to Celsius.

FAILURE MODE - The manner in which a failure occurs, including the operating conditions of the connector at the time of failure.

FEMALE CONTACT - See SOCKET CONTACT.

FERRULE - A bell shaped ring which is placed over a WIRE SEALING GROMMET to provide uniform axial compression of the grommet and to minimize the transmission of torque to the grommet when the endbell is screwed on to the rear of the connector. Ferrules are a part of the sealing mechanism at the rear of a connector. Ferrules are normally a separate component part of the connector although some endbells have integrated ferrules. Ferrules are usually made from a thermoplastic material, but occasionally ferrules are made of metal.

FINISH - See PLATING.

FIRST-MATE LAST-BREAK CONTACT - A contact which is longer than a standard contact or which sits in the insulator in such a way that it mates with the opposing connector half before any of the other contacts. Used to insure that a ground connection between the connector halves mates before, and breaks after, any of the other contacts.

FLANGE - A square mounting flange with four mounting holes for bolting the connector to a panel. The mounting holes may be clearance holes or threaded.

FLANGED RECEPTACLE - The shell of this connector has a square flange with mounting holes at each corner. Mounting holes are usually clearance holes, but may be threaded. Flanged receptacles can usually be front or rear panel mounted depending upon panel thickness. Some connectors have two different versions, one for front mounting, and one for rear panel mounting. As known as a Box Mount or Wall Mount.

FLASH - 1. As commonly used in connector terminology, flash refers to extremely thin platings of metal, for example: gold flash is a very thin plating of gold. So thin, that the thickness is generally not specified. 2. A defect in the molding process or omission of a secondary operation such that undesirable rough edges remain on the connector from the mold gate or seam.

FLASH PLATING - See FLASH (1).

FOLLOWER - See FERRULE.

FOOT-POUND - A unit of measurement equivalent to the work of raising one pound vertically a distance of one foot.

FRONT MOUNTING - A receptacle that can only be mounted to the front of a panel with it's mounting FLANGE outside the equipment.

FRONT RELEASE - For crimp type removable contacts, front release means that the appropriate extraction tool is inserted from the front, or mating face, of the connector. The contact is then pushed out the rear (wire side) of the connector.

g - The international unit for the acceleration of a falling body in the earth's gravitational field, inversely proportional to the square of the distance from the body to the center of the earth. 1g = 32.17 feet per second per second. Connectors are frequently tested by subjecting them to very short duration shocks which are several times the force of gravity while simultaneously confirming electrical continuity.

GAS TIGHT - The mating of two contact surfaces which are so tight that corrosive gasses can not enter the joint.

GEESC - General Electrotechnical Engineering Standards Committee. A European organization which sets standards for electrical devices.

GLAND SEAL - Usually part of an endbell, a gland seal is a resilient element which is compressed around a cable jacket by means of a compression ring. When the proper diameter wire is used and the compression ring is tightened to specifications, the gland creates an air and moisture tight seal around the cable jacket.

GOLD - A precious metal which is more conductive than silver or copper. Because it does not corrode and is highly conductive, it is used as a plating for contacts. It's chemical symbol is Au.

GROMMET - See WIRE SEALING GROMMET.

GROMMET CAVITY - A defined hole in the WIRE SEALING GROMMET through which the wires are passed. The cavities are generally marked with a unique designation or number for ease of use.

GROMMET SEAL - See WIRE SEALING GROMMET.

GUIDE PIN – A special pin which is inserted into a socket contact before the contact can be inserted into the connector insulator. Guide pins provide a rounded surface at the front of the socket and greatly aid in pushing the contact into the insulator thus avoiding damage to both the insulator and the contact. Typically, small size socket contacts require the use of guide pins while larger sizes can be inserted without them.

HALOGEN – A general name applied to four chemical elements, fluorine, chlorine, bromine, and iodine, that have similar chemical properties. As it applies to connector insulating materials, these elements are all high toxic to humans when burned.

HARNES – A group of wires or cables bundled together with attached connectors and/or components in a preshaped assembly.

HEAT SHRINK ENDBELL – An endbell specifically designed to allow heat shrink boots or heat shrink tubing to be applied over it and insure a good bond.

HEAT SHRINK BOOT – A plastic made of nylon or polyolefin which shrinks when heated to provide insulation and environmental protection from wires.

HERTZ – International unit of frequency equal to one cycle per second. That is, 20,000 Hz is 20,000 cycles per second.

HIGH VOLTAGE – A voltage that could cause damage or injury.

H_z – Symbol for Hertz, an International unit of frequency equal to one cycle per second. That is, 20,000 Hz is 20,000 cycles per second.

I.D. – Abbreviation for inside diameter.

IEC – Abbreviation for the International Electrotechnical Commission. An international organization that develops standards exclusively for electrical engineering. CENELEC is the equivalent organization at the European level.

INITIAL – A test result taken prior to any other environmental testing. For example, contact resistance is frequently specified "Initial", that is, with "new" contacts. Most specifications also limit the maximum resistance during or after each of a series of extreme tests, such as "Contact Resistance After Corrosion Test". These figures are typically slightly higher than "Initial".

IN-LINE RECEPTACLE – See CABLE CONNECTING RECEPTACLE.

INDENTOR – The part of a crimping die which indents the contact barrel to form the actual crimp. Indentors normally make six or eight multiple indentation's for each crimp.

INDIVIDUAL WIRE SEALING GROMMET – See WIRE SEALING GROMMET.

INSERT – See INSULATOR.

INSERT ARRANGEMENT – See LAYOUT.

INSERT RETENTION FORCE – The maximum allowable force which should be applied to the face of the insulator without dislodging it from the shell or causing any change in connector performance specifications. Usually stated in Newtons or pounds of force.

INSERTION FORCE – The effort, usually stated ounces or Newtons, required to engage two contacts or connector halves.

INSERTION TOOL – A device used to insert a contact into a connector insulator.

INSPECTION HOLE – A small hole in a crimp contact barrel. A properly crimped contact will allow the user to see the bare wire through the inspection hole. This is verification that the wire is fully seated in the crimp barrel.

INSULATION – A material which has high electrical resistance and is suitable for covering or encasing electrical components to prevent a short circuit.

INSULATION DISPLACEMENT CONNECTOR (IDC) – A connector contact with sharp tines which pierce and displace the wire insulation and make direct electrical connection with the conductor. Normally used with multipin connectors which must be terminated to flat cable. This is a fast, low cost method to terminate many conductors simultaneously.

INSULATION GRIP – See INSULATION SUPPORT.

INSULATION RESISTANCE – The minimum resistance (usually stated in Megohms) between adjacent contacts and between the contacts and the shell at a specific voltage.

When not stated, values are typically given for new insulators. Most specifications also specify minimum resistance figures during or after each of a series of extreme tests, such as "Insulation Resistance During Dry Heat".

INSULATION SUPPORT – An extended portion at the rear of a crimp contact that is crimped around the wire insulation to provide extra strain relief. This crimp is in addition to the crimp over the conductor which provides the actual electrical termination.

INSULATOR – The insulating element into which the contacts are mounted in a connector. This can be a resilient material, thermoplastic, or a thermoset compound, among other materials.

INSULATOR POLARIZATION – See INSULATOR ROTATION.

INSULATOR ROTATION – A method of differentiating a circular connector if more than one connector with the same sex and layout is to be used in a system. The insulator is permanently positioned in the shell so that only a connector with the same degree of rotation can be mated with it. Possible rotations are specific to each layout with some layouts having many possible rotations and others having none. A chart of valid rotations is listed by layout for connectors capable of being rotated. Most connector series use the military convention of assigning letter designations for specific degrees of rotation (for example: W, X, Y, Z). Also see KEYING.

INTERCHANGEABLE – The characteristic of connectors in which a connector half of one manufacturer or series will directly replace that of another manufacturer and provide the same electrical and mechanical function.

INTERFACIAL SEAL – The sealing of mated connectors over the entire face of the mating insulators when the two connector halves are mated. Usually done by employing resilient insulators.

INTERMATEABLE – The characteristic of connectors in which a connector half of one manufacturer or series will mate directly with the connector half of another manufacturer.

INTERMITTENT – Occurring at intervals. A connection which passes electrical current only in random or undesirable intervals.

INTERMOUNTABLE – The characteristic of connectors in which one manufacturer's connector or series will mount in exactly the same panel space and mounting holes as another manufacturer's.

INTRINSIC – A natural or essential property of a system that occurs within.

IP65 – One classification from a rating system used in Europe covering the environmental sealing capability of a connector or enclosure. The system uses two digits, the first digit relates to the degrees of protection the connector has from dirt and dust under the conditions defined in the specification. The second digit relates to the degrees of protection it has against moisture. The degree of protection against dirt ranges from 1 (no protection), to 6 (dust tight). Moisture sealing in the specification ranges from 1 (no protection), to 8 (protected against continuous submersion). The classification IP65 states that the connector is "dust-tight" (6), allowing no ingress of dust what-so-ever, and "protected against water jets" (5), water projected by a nozzle against the connector from any direction shall have no harmful effect.

IP67 – One classification from a rating system used in Europe covering the environmental sealing capability of a connector or enclosure. The system uses two digits, the first digit relates to the degrees of protection the connector has from dirt and dust under the conditions defined in the specification. The second digit relates to the degrees of protection it has against moisture. The degree of protection against dirt ranges from 1 (no protection), to 6 (dust tight). Moisture sealing in the specification ranges from 1 (no protection), to 8 (protected against continuous submersion). The classification IP67 states that the connector is "dust-tight" (6), allowing no ingress of dust what-so-ever, and "protected against the effects of immersion" (7), the ingress of water in harmful quantity shall not be possible when the connector is immersed in water under defined conditions of pressure and time.

IP69 – One classification from a rating system used in Europe covering the environmental sealing capability of a

connector or enclosure. The system uses two digits, the first digit relates to the degrees of protection the connector has from dirt and dust under the conditions defined in the specification. The second digit relates to the degree of protection it has against moisture. The degree of protection against dirt ranges from 1 (no protection), to 6 (dust tight). Moisture sealing in the specification ranges from 1 (no protection), to 8 (protected against continuous submersion). The classification IP69 states that the connector is "dust-tight" (6), allowing no ingress of dust whatsoever, and "protected against the effects of high pressure steam washing" (9), the ingress of water in harmful quantity shall not be possible when the connector is subjected to high pressure steam washing under defined conditions of pressure and time.

IP RATING – Ingress Protection Rating, describes degrees of protection from objects and water. Used for electrical and mechanical enclosures.

ISO – Abbreviation for the International Organization for Standards. A group that operates at the international level and sets most standards for industry, with the exception of electrical engineering and telecommunications which are set by the IEC and ITU respectively. CEN is the equivalent organization at the European level.

ITU – Abbreviation for International Telecommunications Union. A group which sets international standards for telecommunications. ETSI is the equivalent organization at the European level.

JACKET – The outermost layer of insulation in a cable composed of several wires.

JACKSCREW – A screw attached to one half of a connector pair used to mechanically align, draw them together, and lock them in place.

JAM NUT – See JAM NUT RECEPTACLE.

JAM NUT RECEPTACLE – A top-hat shaped connector (the top of the hat being the mating surface). It is mounted into a round panel hole from the rear. The "brim of the hat" prevents the connector from falling through the hole. A large hex nut (jam nut) is screwed on to the front of the connector to secure it to the panel. Typically, the upper "brim" of the hat contains an O-ring which seals the connector to the panel.

KEY – A mechanism used to polarize connectors by the user. See KEYING.

KEYING – A method of differentiating a connector if more than one connector with the same sex and layout is to be used in a system. The key is usually a pin or other projection which can be located in a contact cavity or slot. The key will prevent a connector without a matching orifice from mating. Keying and POLARIZATION serve the same function, but keying can be done by the user, while polarization is manufactured into the connector and normally can not be altered by the user.

LACING CORD – Several types of cord or ribbon which can be used to tie a group of wires into a bundle or harness.

LAMBDA – Greek letter used to designate wavelength measured in meters.

LANYARD RELEASE – A plug connector with a wire or cable handle (lanyard). The plug can be separated from the receptacle by an axial pull on the lanyard.

LAYOUT – The number, size, and geometric arrangement of the contacts in a connector. When a connector is said to have a certain "layout" it refers to a specific contact configuration. For example, the KPT/KPSE series has a page of drawings showing the arrangement of the contacts in the insulator. Each of these arrangements can be referred to as a layout.

L.E.D. – Abbreviation for light emitting diode. A solid state light source which may emit visible light or light of a higher or lower frequency. One application is for very long life, shock resistant lighted indicators.

LEVELS OF INTERCONNECTION – A system of classifying interconnection devices into one of six categories. Level 1 is chip to lead. It covers interconnections used inside of integrated circuits and passive devices to connect the internal elements to the leads on the device package. Level 2 is device to board. It covers the interconnection of PC mounted parts to the printed circuit board. Level 3 is Board to Backplane. It covers the direct interconnection of PC boards. Level 4 is Board to board. It covers interconnections

between circuit boards within the same enclosure. Level 5 is board to box. It covers interconnection of circuit board to the I/O of the equipment. It forms the system interconnection to the outside world. Level 6 is System to System. It covers external connections of one system to another, for example an interconnection of a computer to its CRT terminal would be a Level 6 interconnect.

LOCATOR – A part of a crimping tool TURRET. Rotation of the locator sets the tool for a particular size or sex contact. Also see TURRET.

LOCK WIRE – A mechanical means of securing a mated pair of threaded connectors. A wire is passed through a hole in the coupling nut and then secured to the shell, endbell, or other surface. Using this technique, the coupling nut can not be removed without cutting the lock wire. Lock wires are used to provide additional vibration resistance or to minimize the possibility of tampering with the connector. Lock wires are unnecessary with bayonet style connectors.

MALE CONTACT – See PIN CONTACT.

MATING LIFE – The minimum number of times a connector can be mated and unmated and still meet all of its design specifications. The maximum life may be much higher than this figure.

MEAN TIME BETWEEN FAILURES – The limit of the ratio of operating time of a connector to the number of observed failures as the failures approach infinity. Abbreviated MTBF.

MICRON – A unit of length equal to 10⁻⁶ meters (.001 millimeters).

MIL – One thousandth of an inch (.001). Used in the United States as unit of length in wire diameters and linear dimensions.

MIL-SPEC – Abbreviation for Military Specification.

MILLI – Prefix meaning one-thousandth (1/1000, .001, or 10⁻³) Abbreviated m.

MILLIAMPER – Abbreviation for milliampere.

MILLIAMPERE – One one-thousandth (.001) of an ampere. Abbreviated mA.

MILLIMETER – Metric unit of linear measure. 1 millimeter = .03937 inches.

MILLIOHM – One one-thousandth (.001) of an ohm.

MILLISECOND – One thousandth of a second (.001). Abbreviated ms.

MILLIVOLT – One thousandth of a volt (.001). Abbreviated mV.

mm – millimeter. See MILLIMETER.

mm² – Millimeters squared. A standard for wire diameters used in Europe instead of AWG. As numbers get larger, wire diameters increase in size. The relationship between mm² and AWG is reverse logarithmic. 1 mm² = 1973 circular mils. A conversion graph is needed to make accurate comparisons between AWG and mm². Call for assistance.

MOUNTING CLIP – Any of a variety of mounting accessories used to secure a connector or connector pair to a rigid surface.

MOUNTING FLANGE – See FLANGE and FLANGED RECEPTACLE.

MS – 1. Abbreviation for Millisecond. 2. Abbreviation for Military Specification.

MTBF – Abbreviation for mean time between failures.

MULTI-CONDUCTOR CABLE – Two or more individual wires surrounded by a jacketing material.

N – See NEWTON.

NANO – One billionth (10⁻⁹). Abbreviated n.

NAPKIN RING – One of several designs used for screw machine socket contacts. A band of plated conductive metal is formed around a circumferential cut or opening in the mating portion of contact. This creates a zone of mechanical and electrical continuity between the mated contacts.

NEC – National Electrical Code which contains regulations governing construction and installation of electrical wiring apparatus in the United States.

NEC DIVISION – National Electric Code sets national standards for areas where hazardous gases and/or explosions could occur.

NEMA – Abbreviation for National Electrical Manufacturer's Association. An organization of manufacturers of electrical products that sets various standards for electrical devices. NEMA ratings for degrees of protection against environmental contamination for electrical devices is roughly equivalent to the IP rating system in Europe.

NEST – The portion of a crimping die that supports the contact barrel during crimping.

NEWTON – A unit of acceleration. One Newton is the force capable of accelerating 1 kilogram to one meter per second per second. 1 pound force = 4.448221 Newtons.

NEWTON-METERS – A unit of measure for rotational acceleration. 1 Nm = .7376 Foot Pounds.

Nm – See NEWTON-METERS.

NPT – National Pipe Thread. A standard system of threads used for pipe.

O.D. – Abbreviation for outside diameter.

OHM – The unit of electrical resistance. One ohm is the value of resistance through which a potential difference of one volt will maintain a current of one ampere. Its symbol is the Greek letter omega.

O-RING – A donut shaped ring of rubber used as a seal around the periphery of connectors and connector accessories to form an air, dirt, and moisture tight seal.

OPEN CRIMP CONTACT – Contact which has an opening that remains open until crimped to the wire.

OPERATING TEMPERATURE – The range of AMBIENT TEMPERATURES over which the connector can operate and still meet all of its design specifications.

OPERATING VOLTAGE – The range of voltages over which the connector can be operated. Safety precautions must be taken anytime a voltage in excess of 50V is to be used in a circuit. Check your local and national codes for guidelines

OUTGASSING – The circumstance in which an insulator releases gasses trapped within it under a vacuum or conditions of decreased pressure, high heat, or both.

PANEL – The outside surface of a piece of equipment on to which connectors are mounted. The panel is usually made of metal.

PANEL MOUNT – A connector designed to be mounted on a panel by means of screws or jam nut.

PAIRED CABLE – A cable in which all of the conductors are arranged in the form of twisted pairs.

PC CONNECTOR – A connector with PC contacts.

PC CONTACT – A pin or socket contact that has a post opposite the mating end which is intended to be soldered directly to a printed circuit (PC) board instead of being terminated to a wire. The solder post may come in a variety of diameters and lengths.

PC PIN – See PC CONTACT.

PERIPHERAL SEAL – A resilient seal used to keep moisture from entering the connector at the point where the plug and receptacle shells meet. A common method is to use flat gaskets on receptacles and O-rings on plugs.

PHOSPHOR BRONZE – An alloy of copper, tin, and phosphorus used to make spring contacts. It typically used in lower cost contacts where frequent insertions and withdrawals and high temperatures are not a factor.

PIN – A male contact. See PIN CONTACT.

PIN CONTACT – The contact which has a long shaft at the engagement end which enters the socket contact.

PIZZA BONE – The uneaten, discarded pieces of crust from the outside edge of a slice of pizza.

PLATING – The metallic coatings used on contacts and metal connectors. These are thin layers of metal designed to improve conductivity, solderability, or to resist corrosion. Typical contact finishes are gold or silver. Typical shell finishes are olive drab over cadmium, electroless nickel, or black anodize.

PLUG – The male portion of the connector pair usually employing a coupling nut to secure it to the receptacle half. A Plug may have either pin or socket contacts.

POLARIZATION – A mechanical mechanism that allows connector halves to intermate in only one specific orientation. This can be accomplished by asymmetrical shapes of the two halves as in a D-Subminiature connector, insulator

rotation, keys, keyways, ramps, or other means. Polarization prevents connectors of the same size and/or same layout from intermating when this is undesirable, such as when two otherwise identical connectors are used on the same panel. Polarization is typically done by the assembler and can not be changed by the user, while keying is typically done by the user with an auxiliary keying device.

POLARIZING PIN – See KEY.

POLARIZED BACKSHELL – An ENDBELL with "TEETH" for positioning the endbell.

POSITION – See INSULATOR ROTATION.

POTENTIAL – The difference in voltage between two points in a circuit. Frequently one point is assumed to be ground, which has zero potential.

POTENTIAL DROP – The difference in potential between two ends of a resistance with a current flowing through it. In connector specifications it is the maximum amount of voltage drop in millivolts (or resistance in milliohms) which a contact introduces into the connection. When not stated, values are typically given for "Initial" or new contacts. Most specifications also limit maximum voltage drop (or resistance) during or after each of a series of extreme tests. These figures are typically slightly higher than "Initial".

POT LIFE – The period after the addition of a catalyst during which the compound can be used.

POTTING – The permanent sealing of a cable to a connector using an insulating material such as potting compound to exclude moisture or provide strain relief. See POTTING CUP.

POTTING COMPOUND – A sealing material used in potting to fill a potting cup.

POTTING CUP – A bell-shaped (plastic) endbell with an enlarged opening for the wires. After the connector is loaded with wired contacts, the potting cup is attached to the rear of the connector. The inside of the cup is then filled with a potting compound. When the compound hardens, it forms a solid, permanent, watertight mass around the wires.

POTTING RING – A portion of the POTTING CUP which secures the bell shaped cup to the rear of the connector, usually by means of internal threads.

PRE-TIN – To apply tin-lead solder to contact solder cup and/or conductor prior to soldering the two together.

RACK & PANEL CONNECTOR – A connector made to mount inside a cabinet (rack) which contains electronic modules. These modules have a mating connector half mounted on their rear panels. The modules slide into and out of the rack like a drawer. When fully pushed into the rack, the connector halves self align and mate, connecting the module to the rack system. This arrangement of rack mounted modules makes it easy to quickly interchange modules.

RAMP – A sloped channel that accepts the bayonet pins or roller wheels in a bayonet or reverse bayonet connector. The ramp is part of the mechanism which mechanically locks the two connector halves together.

RANGE – See SEALING RANGE and WIRE RANGE.

RATCHET CRIMP TOOL – A crimping tool with a ratchet mechanism in the handle which will not allow the jaws to open until the crimp dies have closed completely insuring a complete crimp.

REAR MOUNTING – A receptacle that mounts through the panel from the rear, with its mounting flange inside the equipment. Typically, rear mount receptacles are slightly longer than front mount types to allow for the thickness of the panel. Flange mount receptacles usually come in front and rear mount versions. All Jam nut receptacles are rear mount.

REAR RELEASE – Device in the insulator allowing only the removal of contacts from the rear by an extraction tool.

RECEPTACLE – The connector half that mates with the plug. The receptacle has threads, pins or ramps which engage the coupling nut on the plug, locking the two halves together. A receptacle may have either pin or socket contacts.

REDUCTION SLEEVE – A method of crimping a wire on to a crimp contact when the wire diameter is smaller than that accommodated by contact. The sleeve is inserted into the contact crimp barrel and then the wire is inserted into the sleeve. The contact is then crimped. The sleeve increases the diameter of the wire such that standard crimping tools and contacts can be used.

REMOVABLE CONTACT – A contact which can be inserted and removed from the insulator by the user. Insertion tool and extraction tool are normally required to insert and remove the contact.

REMOVAL TOOL – See EXTRACTION TOOL.

RESISTANCE – That property of a substance which impedes current and results in the dissipation of power in the form of heat. The unit of resistance is the ohm.

REVERSE BAYONET COUPLING – A quick coupling mechanism for mechanically mating and unmating connector halves. The plug half has internal roller bolts or pins and the receptacle has ramps. The two halves are mated and unmated by rotating the coupling nut.

RFI – See EMI/RFI.

RING – See COUPLING NUT.

RMS – Abbreviation for root-mean-squared.

RoHS – A Restriction of Hazardous Substances Directive, Restricts the use of hazardous materials in electrical components. Helps reduce the amount of toxic waste.

ROOT MEAN SQUARE – The square root, of the average of the squares, of the values of a periodic quantity (like alternating current), taken through one complete period. It is the effective quantity of a periodic quantity. Abbreviated rms.

ROTATION – See INSULATOR ROTATION.

SAFETY WIRE – See LOCK WIRE.

SALT SPRAY TEST – A test, or series of tests, in which mated and/or unmated connectors are subjected to salt water under specified conditions. Used to test the connector's resistance to corrosion and any associated degradation in electrical function.

SASH CHAIN – A style of metal chain used to secure a DUST CAP to a connector or panel.

SCOOP PROOF – A connector design which includes an elongated shell to prevent the pin contacts from contacting the mating connector face before they are properly aligned for mating. This eliminates the possibility of damaged pins during mating.

SCREW MACHINE CONTACT – A contact made from a solid bar or rod using screw machine operations. Some screw machine contacts include secondary elements which are welded, crimped, or formed around the basic screw machined part to complete the contact.

SEAL – There are generally four types of seals associated with connectors. See PERIPHERAL SEAL, INTERFACIAL SEAL, WIRE SEALING GROMMET, and CABLE SEAL.

SEAL PLUG – See WIRE HOLE FILLER.

SEALING RANGE – The sizes of wire insulation diameter accommodated by a connector's individual wire sealing grommet. Also the diameter of a cable jacket accommodated by a gland seal endbell.

SELECTIVE PLATING – The application of metal PLATING to selective areas of the contact, particularly those areas subject to wear. Precious metal platings may be applied selectively to those contact surfaces responsible for the electrical connection, reducing the contact cost without sacrificing electrical performance.

SERRATIONS – See TEETH.

SERVICE RATING – The service rating is determined by the amount of insulation or creepage distance between contacts. Each layout has a service rating associated with it based upon the operating voltages which can be safely handled by that specific arrangement of contacts.

SHELL – The outside case of a connector into which the insulator and contacts are situated.

SHELL SIZE – A standard system developed for military circular connectors for indicating the diameter of the shell. The system is based upon 1/16" increments, that is, a size 16 shell is one inch in diameter.

SHIELDED CABLE – A cable or group of wires enclosed within a conductive shield. The shield is normally terminated to ground and minimizes the effects of unwanted electrical energy entering or leaving the cable. Shields are made of braided copper, copper foil, or other conductive overlays. The shield is usually enclosed in an insulating jacket. Also See EMI/RFI. Some connector and connector endbells allow the termination and continuation of the shielding effect through the connector. See SHIELDED CABLE ENDBELL.

SHIELDED CABLE ENDBELL – Endbell with a threaded rear ring designed to captivate the braid of a shielded cable and continue the shielding through the connector.

SHOCK – An abrupt impact applied to a stationary object. It is usually expressed in gravities (g).

SHRINK BOOT – A rear accessory made from various types of insulating materials which shrink when specific temperatures are applied to them. Shrink boots are used to add additional insulation, strength, abrasion resistance, or sealing properties to the connector. Boots are supplied to the user in an expanded form, but return to a predefined shape and size when the appropriate amount of heat is applied to them. Various materials and options are available to meet specific user requirements, such as boots with meltable inner adhesive liners which form a moisture tight mass inside the boot after it has been shrunk.

SILICONE – A group of polymers which are rubbery and extremely stable in high temperatures. Silicone is an insulator and is water repellent by nature.

SILVER – A precious metal which is more conductive than copper. Because it does not readily corrode, it is used for contact plating. Its chemical symbol is Ag.

SKID WASHER – A smooth flat washer used to protect the WAVE SPRING from damage.

SLEEVE – A bell-shaped ring that is placed over a WIRE SEALING GROMMET to provide uniform axial compression of the grommet and to minimize the transmission of torque to the grommet when the endbell is screwed onto the rear of the connector. Sleeves are a part of the sealing mechanism at the rear of a connector. Sleeves are normally a separate part of the connector although some endbells have integrated ferrules. Sleeves are usually made from a thermoplastic material but are occasionally made of metal.

SOCKET – A female contact. See SOCKET CONTACT.

SOCKET CONTACT – The contact which has an opening at the engagement end to accept the pin contact.

SOLDER – A melting alloy based of lead, tin, brass, or silver for joining metals together.

SOLDER CONTACT – A contact which is terminated to the wire with solder. Solder contacts are normally bonded into the insulator and can not be removed by the user. The alternative is crimp contacts to which a wire is attached by crimping. Crimp contacts can usually be inserted and removed by the user.

SOLDER CUP – The end of a SOLDER CONTACT designed to accept a wire which will be then soldered to the contact.

STAMPED AND FORMED CONTACT – Contacts made by stamping and forming a sheet of metal rather than by machining metal stock. Also see SCREW MACHINE CONTACTS.

STAR CLIP – One of several designs used for screw machine socket contacts. A tiny plated star shaped clip is captivated inside a solid barrel into which the pin contact fits. The clip creates a multi-point area of mechanical and electrical continuity between the mated contacts.

STEPPED PLANE – A polarization technique where one half of the insulator face is set back below the level of the other half. This creates a stair step front face which fits into the mating connector only when the two stepped planes match. Typically a pin contact is used in the recessed plane while a socket contact is used in the forward plane. The Sure Seal connector makes use of this type of polarization.

STRIP – To remove insulation from a conductor.

STRIP FORM CONTACTS – Stamped and formed crimp contacts supplied on a continuous metal strip for use in automated or semi-automated crimping machines.

STRIP LENGTH – The length of conductor which should be exposed from the insulation at the end of the wire prior to terminating to a contact. Using the appropriate strip length guarantees a connection with maximum

mechanical strength and a minimum of exposed conductor. NOTE: Correct strip lengths are typically quite short. Care should be taken to use the strip length data in this catalog to prepare wires for termination.

STRIPPER – A tool to remove insulation from a wire.

TEETH – A serrated edge on the rear of a connector shell and/or front of an endbell which allows the endbell to be positioned at a specific angle before tightening on to the connector. Used particularly with right angle endbells to position them at a specific angle.

TEST PROD – A sharp metal point with an insulated handle used with various types of test equipment for making an electrical connection between the circuit and the test gear.

TEST VOLTAGE – The range of voltages over which the connector has been tested per the parameters in the applicable specification.

THERMOCOUPLE CONTACT – A contact made of a special material for use with thermocouple probes. Typical contact materials are Alumel, chromel, constantan, or iron.

THERMOPLASTIC – A plastic material that can be softened by heat and rehardened into a solid state by cooling. This process can be accomplished using a variety of techniques.

THERMOSET – A plastic material which hardens when heat and pressure are applied. Unlike thermoplastic, it cannot be remelted or remolded.

THREADED COUPLING – A method of mechanically coupling connector halves which makes use of a threaded coupling nut on the plug which threads into a mating thread on the receptacle.

THRU-BULKHEAD RECEPTACLE – Flange mounted on a panel, the TBR connector has a mating end on each side of the panel, one with pin contacts, and the other with socket contacts. This provides a transition through a panel (or bulkhead). Standard plug style connectors can be mated with the TBR from each side of the panel. TBR's are used when a disconnect is needed from each side of the panel. They are particularly useful when air leakage through the panel must be eliminated.

THROUGH HOLE – See CLEARANCE HOLE.

TORQUE – A force which produces rotation. See ROTATIONAL TORQUE.

TORQUE WRENCH – A device which makes use of an integrated gauge which allows you to tighten coupling nuts, endbells, and bolts to a specific force.

TURRET – An interchangeable device which is attached to a CRIMP TOOL that allows the tool to crimp a range of contacts. Each turret is made to crimp a specific style contact or a range of contacts and/or wire gauges. Also see LOCATOR.

TWISTED PAIR – A cable in which the two insulated conductors are twisted together beneath the jacket. A group of wires in a jacket may also be twisted together in pairs.

UL – Abbreviation for Underwriter's Laboratories, a corporation supported by a group of underwriters for the purpose of establishing safety standards covering certain types of equipment and components in the United States.

UL94 V0 – Plastics burning global standard, V0 means burning will stop within 10 seconds.

USB-A/B – Universal Serial Bus connector with 4 pins. Comes in two styles, A, and B.

V – Symbol for volt.

VAC – Volts, alternating current.

VDC – Volts, direct current.

VDE – A German rating covering performance specifications of a device.

VIBRATION – A continuously reversing change in the magnitude of a given force.

VG 95 234 – A military specification used by the German government and NATO covering reverse bayonet connectors. VG is the equivalent of an MS specification in the United States, in translation from the German, literally meaning Defense (V), Equipment (G).

VOLT – The unit of measurement of electromotive force. It is equivalent to the force required to produce a current of 1 ampere through a resistance of one ohm.

VOLTAGE – The force which causes current to flow through an electrical conductor. Its symbol is E. The greatest effective difference in potential between and two conductors of a circuit.

VOLTAGE DROP – The difference in voltage between two points in a circuit due to the loss of electrical pressure as a current flows through an impedance.

VOLTAGE RATING – The maximum voltage which a connector can sustain without breaking down or varying from design specifications.

W – 1. In circular connectors, a degree of INSULATOR ROTATION. 2. Symbol for watt, work, or energy.

WASH OUT – A defect in the mold used to make molded connector components that manifests itself as a blurred or deformed surface around the area on the component where the mold is gated. It is the result of mold age and wear. It is typically a cosmetic issue that rarely results in any decreased connector performance.

WAVE SPRING – A wavy metal washer mounted inside a coupling nut. When the connector halves are mated, the wavespring applies a reverse pressure on the two mated halves. This is intended to improve vibration performance or peripheral sealing.

WAVE WASHER – See WAVE SPRING.

WIRE BUNDLE – A group of individual wires held together by a wire accessory such as cable ties, lacing cord, tubing, or clamps.

WIRE INSULATION DIAMETER – The outside diameter of the insulation on an insulated wire.

WIRE RANGE – The sizes of wire conductors accommodated by a particular contact.

WIRE HOLE FILLER (also know as a seal plug) – A plug which is inserted into an unused GROMMET CAVITY in a connector to retain the sealing capability of the connector. They can be inserted into unused cavities in the grommet, insulator, or both, however, contacts are always recommended for filling unused insulator cavities. Fillers are usually made of plastic and are commonly found in two shapes, one which resembles a blunt nail and the other shaped like a barb.

WIRE SEALING GROMMET – A resilient disc with holes in it to accommodate the individual wires entering the rear of the connector. Each cavity forms a tight seal against the wire insulation (as long as wires within the specified diameter are used). The grommet seals the back of the connector against moisture, dirt, and air. The grommet is normally held in place and compressed by an endbell and/or ferrule. It is usually a separate component, but may be part of the insulator itself. Also see GROMMET CAVITY.

WIRE SIZE – A numerical designation for conductor diameter. This catalog uses American Wire Gauge (AWG) which is based on the approximate circular mil area of the wire. Also see AWG and mm².

WIRE STRIP LENGTH – See STRIP LENGTH.

WIRE WRAP CONTACT – A type of contact which is terminated by wrapping wire around a post in a manner that deforms the wire and creates a gas tight connection between the wire and the post. This method is slow and labor intensive. If used at all, it is employed in prototype work.

WORK – The magnitude of a force times the distance through which that force is applied.

X – 1. In circular connectors, a degree of INSULATOR ROTATION. 2. Symbol for reactance.

Y – 1. In circular connectors, a degree of INSULATOR ROTATION. 2. Symbol for admittance.

Z – 1. In circular connectors, a degree of INSULATOR ROTATION. 2. Symbol for impedance.

ZERO HALOGEN – In connector terminology, an insulating material that will not emit halogen gasses when burned. See HALOGEN and AEM.

ZERO INSERTION FORCE CONNECTOR (ZIF) – A connector designed in such a way that the contacts do not mechanically touch until the two connector halves have been jointed and a compression mechanism has forced the contacts together. A ZIF connector has extremely low insertion and removal forces making it possible to easily mate very large numbers of contacts with virtually no wear.

CONVERSION CHARTS

If center column value is °F, the °C equivalent is to the left. If center column value is °C, the °F equivalent is to the right.

°C	°F	°C	°F	°C	°F	°C	°F	°C	°F	°C	°F							
-40.00	-40	-40.0		-2.22	28	82.4		35.56	96	204.8		73.33	164	327.2		111.11	232	449.6
-39.44	-39	-38.2		-1.67	29	84.2		36.11	97	206.6		73.89	165	329.0		111.67	233	451.4
-38.89	-38	-36.4		-1.11	30	86.0		36.67	98	208.4		74.44	166	330.8		112.22	234	453.2
-38.33	-37	-34.6		-0.56	31	87.8		37.22	99	210.2		75.00	167	332.6		112.78	235	455.0
-37.78	-36	-32.8		0.00	32	89.6		37.78	100	212.0		75.56	168	334.4		113.33	236	456.8
-37.22	-35	-31.0		0.56	33	91.4		38.33	101	213.8		76.11	169	336.2		113.89	237	458.6
-36.67	-34	-29.2		1.11	34	93.2		38.89	102	215.6		76.67	170	338.0		114.44	238	460.4
-36.11	-33	-27.4		1.67	35	95.0		39.44	103	217.4		77.22	171	339.8		115.00	239	462.2
-35.56	-32	-25.6		2.22	36	96.8		40.00	104	219.2		77.78	172	341.6		115.56	240	464.0
-35.00	-31	-23.8		2.78	37	98.6		40.56	105	221.0		78.33	173	343.4		116.11	241	465.8
-34.44	-30	-22.0		3.33	38	100.4		41.11	106	222.8		78.89	174	345.2		116.67	242	467.6
-33.89	-29	-20.2		3.89	39	102.2		41.67	107	224.6		79.44	175	347.0		117.22	243	469.4
-33.33	-28	-18.4		4.44	40	104.0		42.22	108	226.4		80.00	176	348.8		117.78	244	471.2
-32.78	-27	-16.6		5.00	41	105.8		42.78	109	228.2		80.56	177	350.6		118.33	245	473.0
-32.22	-26	-14.8		5.56	42	107.6		43.33	110	230.0		81.11	178	352.4		118.89	246	474.8
-31.67	-25	-13.0		6.11	43	109.4		43.89	111	231.8		81.67	179	354.2		119.44	247	476.6
-31.11	-24	-11.2		6.67	44	111.2		44.44	112	233.6		82.22	180	356.0		120.00	248	478.4
-30.56	-23	-9.4		7.22	45	113.0		45.00	113	235.4		82.78	181	357.8		120.56	249	480.2
-30.00	-22	-7.6		7.78	46	114.8		45.56	114	237.2		83.33	182	359.6		121.11	250	482.0
-29.44	-21	-5.8		8.33	47	116.6		46.11	115	239.0		83.89	183	361.4		121.67	251	483.8
-28.89	-20	-4.0		8.89	48	118.4		46.67	116	240.8		84.44	184	363.2		122.22	252	485.6
-28.33	-19	-2.2		9.44	49	120.2		47.22	117	242.6		85.00	185	365.0		122.78	253	487.4
-27.78	-18	-0.4		10.00	50	122.0		47.78	118	244.4		85.56	186	366.8		123.33	254	489.2
-27.22	-17	1.4		10.56	51	123.8		48.33	119	246.2		86.11	187	368.6		123.89	255	491.0
-26.67	-16	3.2		11.11	52	125.6		48.89	120	248.0		86.67	188	370.4		124.44	256	492.8
-26.11	-15	5.0		11.67	53	127.4		49.44	121	249.8		87.22	189	372.2		125.00	257	494.6
-25.56	-14	6.8		12.22	54	129.2		50.00	122	251.6		87.78	190	374.0		125.56	258	496.4
-25.00	-13	8.6		12.78	55	131.0		50.56	123	253.4		88.33	191	375.8		126.11	259	498.2
-24.44	-12	10.4		13.33	56	132.8		51.11	124	255.2		88.89	192	377.6		126.67	260	500.0
-23.89	-11	12.2		13.89	57	134.6		51.67	125	257.0		89.44	193	379.4		127.22	261	501.8
-23.33	-10	14.0		14.44	58	136.4		52.22	126	258.8		90.00	194	381.2		127.78	262	503.6
-22.78	-9	15.8		15.00	59	138.2		52.78	127	260.6		90.56	195	383.0		128.33	263	505.4
-22.22	-8	17.6		15.56	60	140.0		53.33	128	262.4		91.11	196	384.8		128.89	264	507.2
-21.67	-7	19.4		16.11	61	141.8		53.89	129	264.2		91.67	197	386.6		129.44	265	509.0
-21.11	-6	21.2		16.67	62	143.6		54.44	130	266.0		92.22	198	388.4		130.00	266	510.8
-20.56	-5	23.0		17.22	63	145.4		55.00	131	267.8		92.78	199	390.2		130.56	267	512.6
-20.00	-4	24.8		17.78	64	147.2		55.56	132	269.6		93.33	200	392.0		131.11	268	514.4
-19.44	-3	26.6		18.33	65	149.0		56.11	133	271.4		93.89	201	393.8		131.67	269	516.2
-18.89	-2	28.4		18.89	66	150.8		56.67	134	273.2		94.44	202	395.6		132.22	270	518.0
-18.33	-1	30.2		19.44	67	152.6		57.22	135	275.0		95.00	203	397.4		132.78	271	519.8
-17.78	0	32.0		20.00	68	154.4		57.78	136	276.8		95.56	204	399.2		133.33	272	521.6
-17.22	1	33.8		20.56	69	156.2		58.33	137	278.6		96.11	205	401.0		133.89	273	523.4
-16.67	2	35.6		21.11	70	158.0		58.89	138	280.4		96.67	206	402.8		134.44	274	525.2
-16.11	3	37.4		21.67	71	159.8		59.44	139	282.2		97.22	207	404.6		135.00	275	527.0
-15.56	4	39.2		22.22	72	161.6		60.00	140	284.0		97.78	208	406.4		135.56	276	528.8
-15.00	5	41.0		22.78	73	163.4		60.56	141	285.8		98.33	209	408.2		136.11	277	530.6
-14.44	6	42.8		23.33	74	165.2		61.11	142	287.6		98.89	210	410.0		136.67	278	532.4
-13.89	7	44.6		23.89	75	167.0		61.67	143	289.4		99.44	211	411.8		137.22	279	534.2
-13.33	8	46.4		24.44	76	168.8		62.22	144	291.2		100.00	212	413.6		137.78	280	536.0
-12.78	9	48.2		25.00	77	170.6		62.78	145	293.0		100.56	213	415.4		138.33	281	537.8
-12.22	10	50.0		25.56	78	172.4		63.33	146	294.8		101.11	214	417.2		138.89	282	539.6
-11.67	11	51.8		26.11	79	174.2		63.89	147	296.6		101.67	215	419.0		139.44	283	541.4
-11.11	12	53.6		26.67	80	176.0		64.44	148	298.4		102.22	216	420.8		140.00	284	543.2
-10.56	13	55.4		27.22	81	177.8		65.00	149	300.2		102.78	217	422.6		140.56	285	545.0
-10.00	14	57.2		27.78	82	179.6		65.56	150	302.0		103.33	218	424.4		141.11	286	546.8
-9.44	15	59.0		28.33	83	181.4		66.11	151	303.8		103.89	219	426.2		141.67	287	548.6
-8.89	16	60.8		28.89	84	183.2		66.67	152	305.6		104.44	220	428.0		142.22	288	550.4
-8.33	17	62.6		29.44	85	185.0		67.22	153	307.4		105.00	221	429.8		142.78	289	552.2
-7.78	18	64.4		30.00	86	186.8		67.78	154	309.2		105.56	222	431.6		143.33	290	554.0
-7.22	19	66.2		30.56	87	188.6		68.33	155	311.0		106.11	223	433.4		143.89	291	555.8
-6.67	20	68.0		31.11	88	190.4		68.89	156	312.8		106.67	224	435.2		144.44	292	557.6
-6.11	21	69.8		31.67	89	192.2		69.44	157	314.6		107.22	225	437.0		145.00	293	559.4
-5.56	22	71.6		32.22	90	194.0		70.00	158	316.4		107.78	226	438.8		145.56	294	561.2
-5.00	23	73.4		32.78	91	195.8		70.56	159	318.2		108.33	227	440.6		146.11	295	563.0
-4.44	24	75.2		33.33	92	197.6		71.11	160	320.0		108.89	228	442.4		146.67	296	564.8
-3.89	25	77.0		33.89	93	199.4		71.67	161	321.8		109.44	229	444.2		147.22	297	566.6
-3.33	26	78.8		34.44	94	201.2		72.22	162	323.6		110.00	230	446.0		147.78	298	568.4
-2.78	27	80.6		35.00	95	203.0		72.78	163	325.4		110.56	231	447.8		148.33	299	570.2
																148.89	300	572.0
																149.44	301	573.8
																150.00	302	575.6

CONDUIT CAPACITY*

Conduit Trade Size	1/2	3/4	1	1 1/4	1 1/2	2	2 1/2	3	3 1/2	4	
Internal Dia. Inches	0.622	0.824	1.047	1.388	1.610	2.067	2.469	3.068	3.548	4.026	
Permissible Area	0.12	0.21	0.34	0.60	0.82	1.34	1.92	2.95	3.96	5.09	
Cable O.D.											
Cable Area Sq. In.											
0.125	0.0123	9	17	27	48	66	108	156	239	321	413
0.150	0.0177	6	11	19	33	46	75	108	166	223	287
0.175	0.0241	4	8	14	24	34	55	79	122	164	211
0.200	0.0315	3	6	10	19	26	42	61	93	126	162
0.225	0.0398	3	5	8	15	20	33	48	74	99	127
0.250	0.0491	2	4	6	12	16	27	39	60	89	103
0.275	0.0594	2	3	5	10	13	22	32	49	66	85
0.300	0.0707	1	2	4	8	11	18	27	41	56	71
0.325	0.0830	1	2	4	7	9	16	23	35	47	61
0.350	0.0963	1	2	3	6	8	13	19	30	41	52
0.375	0.1105	1	1	3	5	7	12	17	26	35	46
0.400	0.1257	-	1	2	4	6	10	15	23	31	40
0.425	0.1419	-	1	2	4	5	9	13	20	27	35
0.450	0.1591	-	1	2	3	5	8	12	18	24	32
0.475	0.1773	-	1	1	3	4	7	10	16	22	28
0.500	0.1964	-	1	1	3	4	6	9	15	20	25
0.525	0.2165	-	-	1	2	3	6	8	13	18	23
0.550	0.2376	-	-	1	2	3	5	8	12	16	21
0.575	0.2597	-	-	1	2	3	5	7	11	15	19
0.600	0.2828	-	-	1	2	2	4	6	10	14	18
0.625	0.3068	-	-	1	1	2	4	6	9	12	16
0.650	0.3319	-	-	-	1	2	4	5	8	11	15
0.675	0.3579	-	-	-	1	2	3	5	8	11	14
0.700	0.3849	-	-	-	1	2	3	4	7	10	13
0.725	0.4129	-	-	-	1	1	3	4	7	9	12
0.750	0.4418	-	-	-	1	1	3	4	6	8	11
0.775	0.4718	-	-	-	1	1	2	4	6	8	10
0.800	0.5027	-	-	-	1	1	2	3	5	7	10
0.825	0.5346	-	-	-	1	1	2	3	5	7	9
0.850	0.5675	-	-	-	1	1	2	3	5	6	8
0.875	0.6014	-	-	-	-	1	2	3	4	6	8
0.900	0.6362	-	-	-	-	1	2	3	4	6	8
0.925	0.6721	-	-	-	-	1	1	3	4	6	8
0.950	0.7089	-	-	-	-	1	1	2	4	5	7
0.975	0.7467	-	-	-	-	1	1	2	3	5	6
1.000	0.7854	-	-	-	-	1	1	2	3	5	6
1.025	0.8252	-	-	-	-	-	1	2	3	4	6
1.050	0.8660	-	-	-	-	-	1	2	3	4	5
1.075	0.9077	-	-	-	-	-	1	2	3	4	5
1.100	0.9504	-	-	-	-	-	1	2	3	4	5
1.125	0.9941	-	-	-	-	-	1	1	2	3	5
1.150	1.0387	-	-	-	-	-	1	1	2	3	4
1.175	1.0844	-	-	-	-	-	1	1	2	3	4
1.200	1.1310	-	-	-	-	-	1	1	2	3	4
1.225	1.1786	-	-	-	-	-	1	1	2	3	4
1.250	1.2272	-	-	-	-	-	1	1	2	3	4
1.275	1.2768	-	-	-	-	-	1	1	2	3	3
1.300	1.3274	-	-	-	-	-	1	1	2	2	3
1.325	1.3789	-	-	-	-	-	-	1	2	2	3
1.350	1.4314	-	-	-	-	-	-	1	2	2	3
1.375	1.4849	-	-	-	-	-	-	1	1	2	3
1.400	1.5394	-	-	-	-	-	-	1	1	2	3
1.425	1.5949	-	-	-	-	-	-	1	1	2	3
1.450	1.6513	-	-	-	-	-	-	1	1	2	2
1.475	1.7088	-	-	-	-	-	-	1	1	2	2
1.500	1.7672	-	-	-	-	-	-	1	1	2	2
1.525	1.8266	-	-	-	-	-	-	1	1	2	2
1.550	1.8870	-	-	-	-	-	-	1	1	2	2
1.575	1.9483	-	-	-	-	-	-	1	1	2	2
1.600	2.0107	-	-	-	-	-	-	1	1	2	2
1.625	2.0740	-	-	-	-	-	-	1	1	2	2
1.650	2.1383	-	-	-	-	-	-	1	1	2	2
1.675	2.2036	-	-	-	-	-	-	1	1	2	2
1.700	2.2699	-	-	-	-	-	-	1	1	2	2
1.725	2.3371	-	-	-	-	-	-	1	1	2	2
1.750	2.4053	-	-	-	-	-	-	1	1	2	2
1.775	2.4745	-	-	-	-	-	-	1	1	2	2
1.800	2.5447	-	-	-	-	-	-	1	1	2	2

WIRE GAUGE

AWG	Diameter Inches	Diameter MM	CMA
4/0	0.460	(11.68)	212000
3/0	0.410	(10.41)	168000
2/0	0.365	(9.27)	133000
1/0	0.325	(8.26)	106000
1	0.289	(7.34)	83700
2	0.258	(6.55)	66400
3	0.229	(5.82)	52600
4	0.204	(5.18)	41700
5	0.182	(4.62)	33100
6	0.162	(4.11)	26300
7	0.144	(3.66)	20800
8	0.128	(3.25)	16500
9	0.114	(2.90)	13100
10	0.102	(2.59)	10400
11	0.091	(2.31)	8230
12	0.081	(2.06)	6530
13	0.072	(1.83)	5180
14	0.062	(1.57)	4110
15	0.057	(1.45)	3260
16	0.051	(1.30)	2580
17	0.045	(1.14)	2050
18	0.040	(1.02)	1620
19	0.036	(0.91)	1290
20	0.032	(0.81)	1020
21	0.0285	(0.72)	810
22	0.0253	(0.643)	642
23	0.0226	(0.574)	509
24	0.0201	(0.511)	404
25	0.0179	(0.45)	320
26	0.0159	(0.404)	254
27	0.0142	(0.361)	202
28	0.0126	(0.320)	106
29	0.0113	(0.29)	127
30	0.0100	(0.254)	101
31	0.0089	(0.23)	79.7
32	0.0080	(0.20)	63.2
33	0.0071	(0.18)	50.1
34	0.0063	(0.16)	39.8
35	0.0056	(0.14)	31.5
36	0.0050	(0.13)	25.0
37	0.0045	(0.114)	19.8
38	0.0040	(0.10)	15.7
39	0.0035	(0.09)	12.5
40	0.0031	(0.079)	9.9

Use to Convert American Wire Gauge to Diameter and Circular Mil Area.

Figures shown indicate number of cables of a given size O.D. that can be pulled through conduit size listed.

*Based on National Electrical Code for non-lead sheathed cables when 3 or more wires occupy the same conduit (40% fill).

CONVERSION FACTORS

MULTIPLY	BY	OBTAIN
acres	0.4047	hectares
atmospheres	1.10133	bars
atmospheres	0.0001033	kg per square meter
atmospheres	760	mm of mercury at 0°C
atmospheres	0.000010133	newtons per square meter
atmospheres	14.7	pounds per square inch
bars	0.9869	atmospheres
bars	100000	newtons per square meter
Btu	778.3	foot-pounds
Btu	0.000293	kilowatt-hours
Btu per hour	12.96	foot-pounds per minute
Btu per minute	17.58	watts
centimeters	0.03281	feet
centimeters	0.3937	inches
centimeters per second	1.969	feet per minute
centimeters per second	0.6	meters per minute
circular mils	0.000005067	square centimeters
circular mils	7.854E-07	square inches
circular mils	0.0005067	square millimeters
circular mils	0.7854	square mils
cubic centimeters	0.06102	cubic inches
cubic centimeters	0.001	liters
cubic feet	1728	cubic inches
cubic feet	0.02832	cubic meters
cubic feet	7.481	gallons (US liquid)
cubic feet	28.32	liters
cubic inches	16.393	cubic centimeters
cubic inches	0.0005787	cubic feet
cubic inches	0.00001639	cubic meters
cubic inches	0.01639	liters
cubic meters	35.31	cubic feet
cubic meters	1000	liters
dynes	0.00102	grams
dynes	0.00001	newtons
dynes	0.000002248	pounds
feet	30.48	centimeters
feet	12	inches
feet	0.0003048	kilometers
feet	0.06061	rods
feet of water (4°C)	0.8826	inches of mercury (0°C)
feet of water (4°C)	304.8	kg per square meter
feet of water (4°C)	62.43	pounds per square foot
feet per minute	0.508	centimeters per second
feet per minute	0.3048	meters per minute

MULTIPLY	BY	OBTAIN
feet per minute	0.01136	miles per hour
foot-pounds	0.001285	Btu
foot-pounds	1.356	joules
foot -pounds	0.1383	kilogram-meters
foot -pounds	3.766E-07	kilowatt-hours
foot-pounds	1.3557	newton-meters
foot-pounds per minute	0.07716	Btu per hour
foot-pounds per minute	0.0226	watts
gallons (US liquid)	0.1337	cubic feet
gallons (US liquid)	0.003785	cubic meters
gallons (US liquid)	4	quarts
grams	980.7	dynes
grams	0.03527	ounce
grams per cm	0.0056	pounds per inch
grams per cubic cm	0.03613	pounds per cubic inch
grams per sq cm	2.0481	pounds per square foot
hectares	2.471	acres
hectares	10000	square meters
horsepower	1.014	horsepower (metric)
horsepower (metric)	0.9863	horsepower
inches	2.54	centimeters
inches	0.08333	feet
inches	0.0254	meters
inches	25.4	millimeters
inches	1000	mils
inches	0.02778	yards
inches of mercury (0°C)	1.133	feet of water (4°C)
inches of mercury (0°C)	0.4912	pounds per square inch
inches of mercury (32°F)	33.86	millibars
inches of water (4°C)	0.07355	inches of mercury
inches of water (4°C)	25.4	kg per square meter
inches of water (4°C)	0.5782	ounces per square inch
inches of water (4°C)	5.202	pounds per square foot
joules	0.7376	foot-pounds
joules	9.81	kilogram-meters
kilograms	9.807	newtons
kilograms	2.2046	pounds
kilogram-calories per min.	69.77	watts
kilogram-force	9.81	newtons
kilogram-meters	7.233	foot -pounds
kilogram-meters	0.102	joules
kilograms per meter	0.672	pounds per foot
kilograms per meter	0.056	pounds per inch
kilograms per sq. meter	0.00009678	atmospheres

CONVERSION FACTORS

MULTIPLY	BY	OBTAIN
kilograms per sq. meter	0.003281	feet of water (4°C)
kilograms per sq. meter	0.2048	pounds per square foot
kilograms per sq. meter	0.001422	pounds per square inch
kilometers	3281	feet
kilometers	0.62137	miles
kilometers per hour	0.9113	feet per second
kilometers per hour	16.67	meters per minute
kilometers per minute	37.28	miles per hour
kilowatt-hours	3413	Btu
kilowatt-hours	0.00002655	foot -pounds
liters	1000	cubic centimeters
liters	0.03531	cubic feet
liters	61.02	cubic inches
liters	0.001	cubic meters
liters	0.908	quarts (dry)
liters	1.0567	quarts (US liquid)
meters	39.37	inches
meters	0.000394	mils
meters	1.0936	yards
meters per minute	1.667	centimeters per second
meters per minute	3.281	feet per minute
meters per minute	0.06	kilometers per hour
metric tons	0.9842	English long ton (2240 lbs)
metric tons	1.102	tons, short (2000 lbs)
miles (statute)	1.6094	kilometers
miles per hour	88	feet per minute
miles per hour	0.02682	kilometers per minute
millibars	0.02953	inches of mercury (32°F)
millibars	2.089	pounds per square foot
millimeters	0.03937	inches
millimeters	0.3937	mils
mm of mercury at 0°C	0.001316	atmospheres
mils	0.001	inches
mils	0.0000254	meters
mils	0.0254	millimeters
newtons	100000	dynes
newtons	0.102	kilograms
newtons	0.22481	pounds force
newton-meters	0.7376	foot-pounds
newton-meters	8.8512	inch-pounds
newtons per sq meter	0.00009678	atmospheres
newtons per sq meter	0.00001	bars
ounce	28.35	grams
ounces per square inch	1.729	inches of water (4°C)

MULTIPLY	BY	OBTAIN
pints	0.5	quarts
pounds	0.00004448	dynes
pounds	0.4536	kilogram
pounds force	4.44822	newtons
pounds per cubic foot	0.0005787	pounds per cubic inch
pounds per cubic inch	27.68	gram per cubic cm
pounds per cubic inch	1728	pounds per cubic foot
pounds per foot	1.488	kg per meter
pounds per inch	178.6	grams per cm
pounds per inch	17.86	kg per meter
pounds per square foot	0.01602	feet of water (4°C)
pounds per square foot	0.4883	grams per sq cm
pounds per square foot	0.1922	inches of water (4°C)
pounds per square foot	4.882	kg per square meter
pounds per square foot	4.882	kg per square meter
pounds per square foot	0.4788	millibars
pounds per square foot	0.006944	pounds per sq inch
pounds per square inch	0.06804	atmospheres
pounds per square inch	2.036	inches mercury (0°C)
pounds per square inch	703.1	kg per square meter
pounds per square inch	144	pounds per sq foot
quarts	0.25	gallons (US liquid)
quarts (dry)	1.1	liters
quarts (US liquid)	0.9463	liters
quarts	2	pints
rods	16.5	feet
square centimeters	0.00001973	circular mils
square centimeters	0.155	square inches
square feet	0.0929	square meters
square inches	0.00001273	circular mils
square inches	6.452	square centimeters
square kilometers	0.386	square miles
square meters	0.0001	hectares
square meters	10.76	square feet
square miles	2.59	square kilometers
square millimeters	1973	circular mils
square mils	1.273	circular mils
tons, English long (2240 lbs)	1.016	metric tons
tons, short (2000 lbs)	0.9072	metric tons
watts	0.05689	Btu per minute
watts	44.26	foot-pound per minute
watts	0.01433	kg-calories per minute
yards	0.02778	inches
yards	1.0936	meters

Corporate Headquarters, Philadelphia, PA



North American Production Facility, South Bend, IN



European Headquarters and Production Facility, Southampton, UK



Zhuhai, China Production Facility



PEI-Genesis has sales offices throughout the Americas, Europe and Asia.
Visit www.peigenesis.com, call +1 800.675.1214 (North America), +44 (0) 23 8062 1260 (Europe),
+86 756 7683 088 (Asia), +1 631.475.5050 (Rest of World), or email: sales@peigenesis.com.

www.peigenesis.com

©2018 PEI-Genesis. All rights reserved. PEI-Genesis logo is a trademark of PEI-Genesis.
All other trademarks and service marks are the property of their respective owners.