

Part Detail

Please see the details of the part you have configured. Note that Carling reserves the right to change product details and specification without prior notice.

Catalog Number

V1B2UJJ4-6A811-000

Specifications

Part Number: V1B2UJJ4-6A811-000

CONTURA X & XI ROCKER SWITCH SERIES

SINGLE POLE: ON-NONE-OFF

RATING: 15A 24V

10 TERM BASE: .250" TABS; NO BARRIERS ON BASE; NO JUMPERS

SEALED - LAMPS 1 & 2 INDEPENDENT

LAMP 1 - SUPERBRIGHT GREEN; 24VDC

LAMP 2 - SUPERBRIGHT GREEN; 24VDC

BLACK RAISED BRACKET; 1 GASKET

CONTURA XI, BLACK ACTUATOR

OVER LAMP 1, WHITE SQUARE LENS W/ CLEAR TOP PROTECTIVE LENS

OVER LAMP 2, WHITE BAR STYLE LENS

LEGEND: ON-OFF (VERTICAL)

ORIENTATION OF SWITCH IN PANEL DETERMINED BY LEGEND CHOICE

NO LEGEND IN SECOND LOCATION (LAMP #2)

Additional Comments

Part Image for V1B2UJJ4-6A811-000

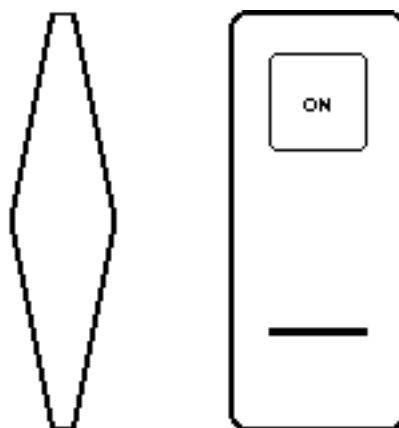

NOTE: NOT DRAWN TO SCALE. SOME LEGENDS MAY APPEAR DISPROPORTIONATELY SMALL

V-Series

Contura® X, XI & XII

Sealed Rocker Switches

PRODUCT WEBPAGE

request sample, configure part, watch video



Contura® IP66/68 Snap-In Mounted Switches

The Contura X, XI and XII feature a raised bracket/bezel, which helps prevent inadvertent actuation of the switch. For increased durability of imprinted lens symbols, square lenses are offered in 1-piece or 2-piece constructions. The Contura XII features paddle actuators

1-2
Poles

.4-20
Amps

125-250
VAC

12-24
VDC

Typical Applications

- On/Off-Highway
- Marine
- Armored Vehicles
- Industrial Automation
- Commercial Food
- Medical Equipment
- Any Application Requiring Sealing Protection

Design Features

INTERCHANGEABLE ACTUATORS

Panel redesign is a snap with our wide range of rocker styles. Achieve maximum design variety with minimum inventory. Simply swap rockers to create an entirely new look for your panel.

DUAL SEAL PROTECTION

Seals out water, dust, debris, and sealed to IP66/68 for above-panel components

CLEAN CONNECTIONS

Options for both eight and ten terminal base styles with AMP & Packard compatible connectors affords myriad circuit options while providing ease of assembly.

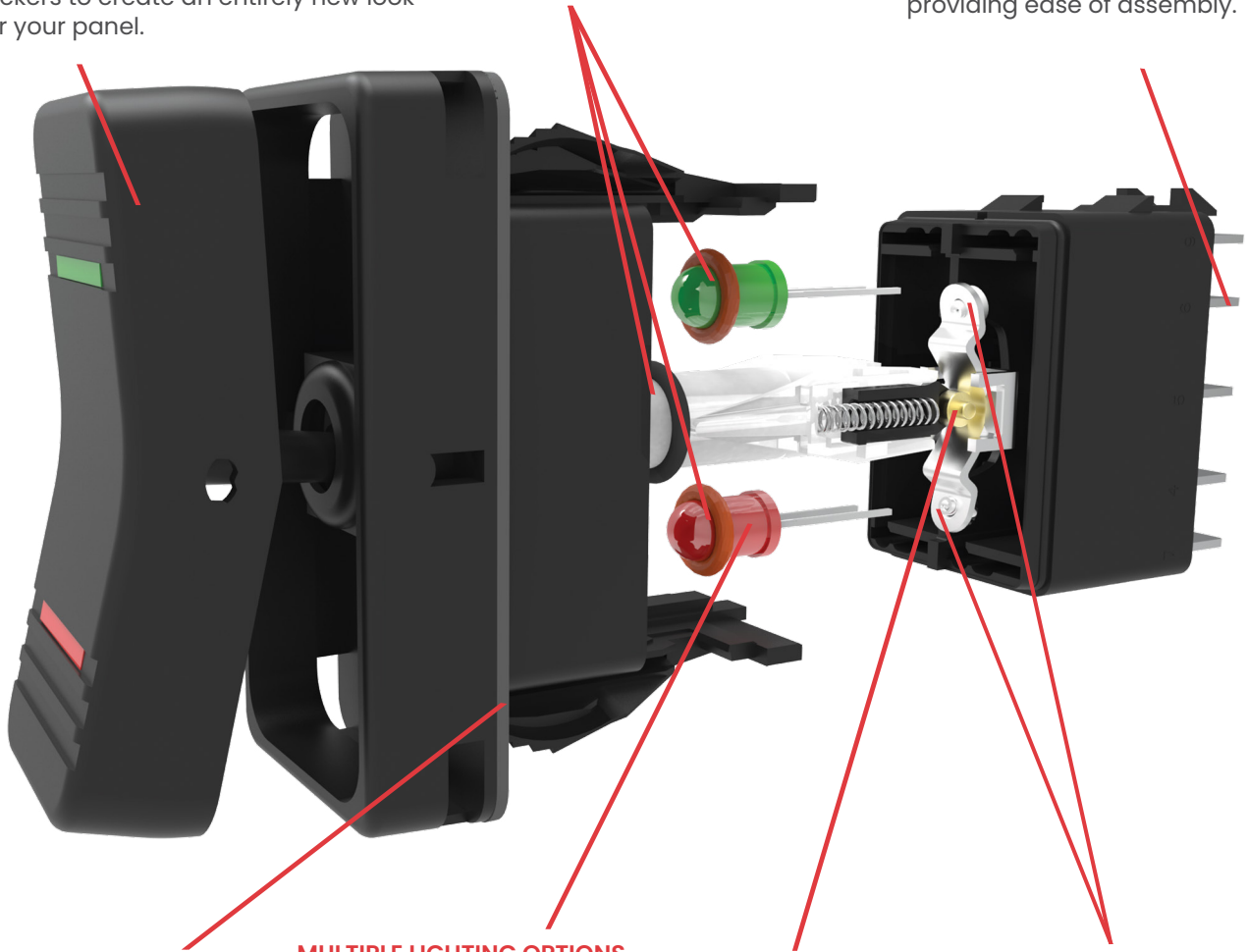

OPTIONAL PANEL SEAL

Helps prevent water/dust ingress behind panel.

MULTIPLE LIGHTING OPTIONS

In addition to Incandescent lamps, our LED illumination is offered in a wide array of light intensities, colors, as well as dual level, tri-color, and flashing options.

BRASS ROLLER PIN

Robust mechanism eliminates the need for lubricants. Enables switch to withstand -40°C to $+85^{\circ}\text{C}$ temperatures.

SILVER PLATED BUTT CONTACT MECHANISM

Providing 50k to 100k electrical cycles, circuit and load dependent

Actuator Options & Accessories

Contura II & III



The Contura II & III actuators are constructed of thermoplastic polycarbonate and are offered with a hard nylon overlay or a “soft-touch” elastomer overlay. These models incorporate aesthetic designs on the top and bottom of the rocker featuring two rows of raised “bumps” on the Contura II and three “indented” lines on the Contura III.

Contura X



The raised bracket/bezel on the Contura X helps prevent inadvertent actuation of the rocker, as well as preventing debris from being trapped under the actuator. This curved rocker style is available with a variety of lenses and legends.

Contura IV



The Contura IV’s “Shape to create a Shape” actuator works with the curves, contours & advanced styling of the latest panel designs, flowing with these advanced curves & radii. This actuator style fits on the Contura flush bracket/bezel.

Contura XI



The raised bracket/bezel on the Contura XI helps prevent inadvertent actuation of the rocker, as well as preventing debris from being trapped under the actuator. This convex style rocker is available with a wide variety of lenses and legends.

Contura V



The symmetrically curved Contura V actuator provides the perfect complement to the Contura IV’s “Shape to create a Shape” design concept. With its flush style mounting bracket, Contura V can be mounted in between two Contura IV’s, by itself, or in groups.

Contura XII



The Contura XII version features a paddle style actuator with the raised bracket/bezel of Contura X and XI. The contoured handle design provides intuitive recognition and ease of operation and is available with all Contura X and XI lens and legend offerings.

Contura VI (WAVE)



The Contura VI WAVE sealed rocker switches, when used in a row, create an uniquely appealing “wave” design on your panel. A variety of colors and finishes are available for both rocker and wave insert. Contura VI features bar and oval lenses.

Contura XIV



The Contura XIV represents a sleek new crossover rocker design which should appeal to Trucks, Buses and Heavy Vehicles as well as the Marine Industry. Intuitive feel is provided by recessed ridges along with a Center Groove which effectively defines the boundary between top and bottom switch functions.

Contura VII



Contura VII featuring gently curved corners and edges assuring compatibility with most any panel design. Intuitive feel is maximized by the use of 2 embossed circular pads located at opposite ends of the rocker. Any combination of Bar or Oval style lenses can be located in the pads providing a truly unique look, exclusive to Contura VII.

Illuminated Indicators & Accessories



Alert operator of systems functions or malfunctions, are offered with removable/replaceable lamps in Contura II, II, V or X styles. Accessories include connectors, mounting panels, hole plugs, panel seals, and actuator removal tools. Refer to accessories page for full details

Tech Specs

Electrical

Contact Rating	4VA @ 24VDC (MAX) resistive 15 amps, 125VAC 10 amps, 250VAC 1/2 HP 125-250VAC 20 amps, 4-14VDC 15 amps, 15-28VDC 10A, 14VT 6A, 125VAC L
Dielectric Strength	1500 Volts RMS
Insulation Resistance	50 Megohms
Initial Contact Resistance	10 milliohms max. @ 4VDC
Life	Up to 100,000 cycles, circuit and load dependent
Contacts	Silver alloy, silver tin-oxide, fine silver
Terminals	Brass or copper/silver plate 1/4" (6.3mm) Quick Connect terminations standard. Solder lug, Wire Lead

Physical

Lighted	Incandescent - rated 10,000 hours Neon - rated 25,000 hours LED - rated 100,000 hours 1/2 life (LED is internally ballasted for voltages to 24VDC)
Seals	Internal Optional external gasket panel seal
Base	Polyester blend rated to 125°C with a UL flammability rating of 94V0.
Contura II, III, IV, V, VI, VII Actuator	Hard Surface: Basic actuator structure molded of thermoplastic polycarbonate with a hard Nylon 66 thermoplastic surface overlay. Soft Surface: Basic actuator structure molded of thermoplastic polycarbonate with an elastomer overlay.
Contura X, XI, XII Actuator, VP	Nylon 66 Reinforced rated to 105°C
Lens	Polycarbonate rated at 100°C
Contura XIV	Polycarbonate lens/sub-rocker with ABS shell

Actuator Travel (Angular Displacement)

2 position	18°
3 positions	9° from center

Environmental

Sealing	IP66/68, for above-panel components of actual switch only.
Corrosion	Mixed Flowing Gas (MFG) Class III 3 year accelerated exposure per ASTM B-827, B-845 Silver and gold contacts
Operating Temp	-40°C to +85°C
Vibration 1	Per Mil-Std 202F, Method 204D Test Condition A 0.06 DA or 10G's 10-500 Hz. Tested with VCH connector. Test criteria - No loss of circuit during test, pre and post test contact resistance.
Vibration 2	Resonance search 24-50 Hz 0.40 DA 50-2000 Hz ±10 G's peak Horizontal Axis 3-5 G's max. Random 24 Hz 0.06 PSD-Gsq/Hz 60 Hz 0.50 100 Hz 0.50 200 Hz 0.025 2000 Hz 0.025 No loss of circuit during test; <10µ seconds chatter.
Shock	Per Mil-Std 202F, Method 213B, Test Condition K @ 30G's. Tested with VCH connector. Test criteria - No loss of circuit during test, pre and post test contact resistance.
Salt Spray	Per Mil-Std 202F, Method 101D, Test Condition A, 96 Hrs. Sealed version only.
Dust	Mil STD 810, Method 510.2 Air Velocity 300 Ft/Min Duration 16Hr
Thermal Shock	Per Mil-Std 202F, Method 107F, Test Cond. A, -55°C to +85°C. Test criteria -pre and post test contact resistance
Moisture Resistance	Per Mil-Std 202F, Method 106F, Test Criteria - pre and post test contact resistance
Ignition Protection	All Contura switches with sealed construction meet the requirements of UL1500/ISO8846 for ignition protection, in addition to conformance with EC directive 94/25/EC for marine products.

Mounting Specifications

Panel Thickness Range
Gaskets Acceptable Panel Thickness

0	.030 to .250 (.76 to 6.35mm)
1	.030 to .109 & .147 to .157 (.76 to 2.77mm & 3.73 to 3.98mm)

Recommended: No gasket with panel thickness of .032, .062, .093, .125, .187 or .250

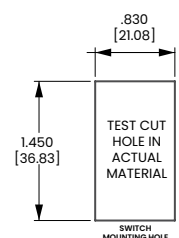

Ordering Scheme

Contura X, XI & XII

Sample Part Number

V 1 D A B 6 0 1 - 6 P Z 00 - 0 00

Selection

1 2 3 4 5 6 7 8 9 10 11 12 13 14

1. SERIES

V V-Series

2. CIRCUIT

Terminal Connections as viewed () - momentary from bottom of switch: SP - single pole: terminals 1, 2 & 3.
 8 terminal 10 terminal DP - double pole: terminals 1, 2, 3, 4, 5 & 6.
 Terminals 7, 8, 9 & 10 for lamp circuit only.

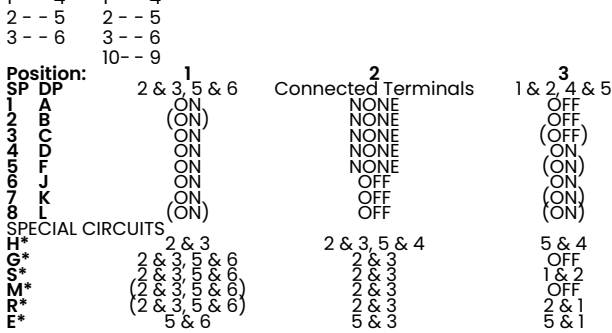

*Jumper between terminals 2 & 5 for circuits H,G,M,R & S are specified in selection 4. External jumper between terminals 2 & 4 for circuit E are provided by customer. Circuit E may be used for SP OFF-ON-ON circuit.

3. RATING

1	.4VA @ 28VDC Resistive
B	15A 24V
C	20A 18V
D	20A 12V
E	20A 14V, 10A 14VT (circuit 1, 4, A & D only)
F	10A 14V, 6A 14VT (circuit G only)
M	.4VA/20A 12V
N	.4VA/15A 24V

4. TERMINATION / BASE STYLE

8 term	10 Term	Termination	Jumper
1	2	.250 TAB (QC) no barriers	No
A	B	.250 TAB (QC) with barriers	No
J	K	.250 TAB (QC) no barriers	Yes T2 to 5
3	4	Solder Lug no barriers	No
C	D	Solder Lug	No
5	6	Wire Leads no barriers	No
E	F	Wire Leads	No

Note: Codes J & K for circuits H, G & M. Do not use silicone based lubricants to reduce terminal insertion forces during connector assembly, as it is detrimental to function and performance.

5. ILLUMINATION & SWITCH SEALING

Lamp #1: above terminals 1 & 4 end of switch.; Lamp #2 above terminals 3 & 6 end of switch. Positive (+) and negative (-) symbols apply to LED lamps only

Sealed	Unsealed	Lamps	Illumination Type	Lamp wired to Terminal
S	0	NONE		
A	1	1	INDEPENDENT	8 (+) 7 (-)
B	2	1	DOWN	3 (+) 7 (-)
C	3	2	UP	3 (+) 7 (-)
D	4	1	DOWN	3 (+) 7 (-)
E	5	2	DOWN	1 (+) 7 (-)
F	6	1	UP	3 (+) 7 (-)
G	7	2	UP	8 (+) 7 (-)
H	Z	1	INDEPENDENT	8 (+) 7 (-)
U	Y	1	INDEPENDENT	8 (+) 7 (-)
		2	INDEPENDENT	10 (+) 9 (-)
SINGLE POLE SWITCHES ONLY				
J	8	1	DOWN	3 (+) 8 (-)
		2	INDEPENDENT	6 (+) 7 (-)
K	W	1	INDEPENDENT	8 (+) 7 (-)
		2	INDEPENDENT	6 (+) 7 (-)
DOUBLE POLE SWITCHES ONLY				
L	9	1	DOWN	3 (+) 6 (-)
M	R	1	UP	3 (+) 6 (-)
N	T	1	DOWN	3 (+) 6 (-)
		2	DOWN	1 (+) 4 (-)
P	V	1	UP	1 (+) 4 (-)
		2	UP	3 (+) 6 (-)

6,7. LAMP (SAME CODING FOR BOTH SELECTIONS)

Selection 6: above terminals 1 & 4; Selection 7: above terminals 3 & 6

No lamp	0				
Neon	1 125VAC	2 250VAC			
Incandescent LED*	4 3V	5 6V	6 12V superbright Green	7 18V superbright Red	8 24V
2VDC	A	L	F	R	
6VDC	B	M	G	S	
12VDC	C	N	H	T	
24VDC	D	P	J	V	

*Consult factory for "daylight bright" LED. Typical current draw for LED is 20ma

8. FLUSH BRACKET COLOR, PANEL SEAL

X & XI with Flush Bracket		X, XI, XII with Raised Bracket	
# of gaskets	0 1 2	0 1	
Black	B C D	1 4	
White	W Y Z	2 5	
Gray	G H J	3 6	

9. ACTUATOR

No Actuator	0				
Contura X	1 Black	Gray	White	Red	
Contura XI	6	7	8	9	
Contura XII	J	K	N	M	

Actuator orientation over terminals: 3,6 1,4

10. LENS - ABOVE LAMP #1 TERMINALS

0 - No Actuator	Z - No Lens				
Clear	White	Amber	Green	Red	Blue
3	8	D	J	P	V
4	9	E	K	R	W
5	A	F	L	S	Y
2	7	C	H	N	U
1	6	B	G	M	T

Lens Style: Bar, One piece Square, Two piece Square* (With clear top protective lens), Two piece Square* (With smoke top protective lens), Two piece Square* (With white top protective lens)

* All bottom lenses are molded of opaque material. Consult factory for other lens colors. Lens color for LEDs must be clear, white, or match color of LED. Green or blue lenses are not recommended with Neon lamps.

12. ACTUATOR LENS OR BODY LEGENDS

00 - No Legend this location / No actuator					
11 ON	12 OFF	13 I	14 O		
OFF	ON	O	I		
15 O	16 O	17 O	18 I		
F N	N F				
F	F				
21 OFF	22 ON	23 O	24 I		
25 O	26 O	27 O	28 I		
F N	N F				
F	F				

For additional legend options & codes, visit us at www.carlingtech.com

13. ACTUATOR LENS OR BODY LEGENDS

0	No legend (used with codes 11-18 in selection 12)				
1	Orientation 1				
2	Orientation 2				
3	Orientation 3				
4	Orientation 4				

16. ACTUATOR LENS LEGEND

00 No legend this location / no actuator (used with codes 11-18 in selection 12) Selection 14 required when switch requires two legends. If the two legends consist of one lens and one body legend, lens legend must be specified in selection 12; body legend specified in selection 14. For legend options & codes, visit us at www.carlingtech.com.

- Notes: Consult factory to verify horsepower rating for your particular circuit choice.
- Custom colors are available. Consult factory.
 - White imprinting is standard on black actuators; Black imprinting is standard on white, red & gray actuators. Custom colors are available, consult factory.
 - With 2 square lenses, use selection 12 for lens above lamp 1, & selection 14 for lens above lamp 2.
 - Additional ratings available. See V-Series Switch Accessories page.
 - Not available with Contura XI rockers.

Ordering Scheme

Contura X locking

Sample Part Number

V 1 D A S W 0 1 - 1 P B 00 - 0

Selection 1 2 3 4 5 6 7 8 9 10 11 12 13

1. SERIES

V V-Series

2. CIRCUIT

Terminal Connections as viewed () - momentary from bottom of switch: SP - single pole: terminals 1, 2 & 3.
8 terminal **10 terminal** DP - double pole: terminals 1, 2, 3, 4, 5 & 6.
 8 - - 7 8 - - 7 Terminals 7, 8, 9 & 10 for lamp circuit only.
 1 - - 4 1 - - 4
 2 - - 5 2 - - 5
 3 - - 6 3 - - 6
 10 - - 9

Position:	1	2	3
SP DP	2 & 3, 5 & 6	Connected Terminals	1 & 2, 4 & 5
1 A	ON	NONE	OFF
4 D	ON	NONE	ON
6 J	ON	OFF	ON
9 N	OFF	NONE	ON

SPECIAL CIRCUITS	2 & 3	2 & 3, 5 & 4	5 & 4
H*	2 & 3	2 & 3	OFF
G*	2 & 3, 5 & 6	2 & 3	1 & 2
S*	2 & 3, 5 & 6	5 & 3	5 & 1
E*	5 & 6		

*Jumper between terminals 2 & 5 for circuits H,G,M,R & S are specified in selection 4. External jumper between terminals 2 & 4 for circuit E are provided by customer. Circuit E may be used for SP OFF-ON-ON circuit.

3. RATING 4

1	.4VA @ 28VDC Resistive
B	15A 24V
C	20A 18V
D	20A 12V
E	20A 14V, 10A 14VT (circuit 1, 4, A & D only)
F	10A 14V, 6A 14VT (circuit G only)
M	.4VA/20A 12V
N	.4VA/15A 24V

4. TERMINATION / BASE STYLE

8 term	10 Term	Termination	Jumper
1	2	.250 TAB (QC) no barriers	No
A	B	.250 TAB (QC) with barriers	No
J	K	.250 TAB (QC) no barriers	Yes T2 to 5
3	4	Solder Lug no barriers	No
C	D	Solder Lug	No
5	6	Wire Leads no barriers	No
E	F	Wire Leads	No

Note: Codes J & K for circuits H, G & M. Do not use silicone based lubricants to reduce terminal insertion forces during connector assembly, as it is detrimental to function and performance.

5. ILLUMINATION & SWITCH SEALING

Lamp #1: above terminals 1 & 4 end of switch; Lamp #2 above terminals 3 & 6 end of switch. Positive (+) and negative (-) symbols apply to LED lamps only

Sealed Terminals	Unsealed	Lamps	Illumination Type	Lamp wired to Terminals
S	0	NONE	-	-
C	3	2	UP	3 (+) 7 (-)
H	Z	2	INDEPENDENT	8 (+) 7 (-)
DOUBLE POLE SWITCHES ONLY				
M	R	1	UP	3 (+) 6 (-)

6. LOCKS

Lock above terminals 1 & 4 end of switch.
W Lock

Notes: Consult factory to verify horsepower rating for your particular circuit choice.

- Custom colors are available. Consult factory.
- White imprinting is standard on black actuators; Black imprinting is standard on white, red and gray actuators; Custom colors are available, consult factory.
- Located over T1-4 end of switch.
- Additional ratings available. See V-Series Switch Accessories page.
- Located over T3-6 end of switch.

6.7. LAMP (SAME CODING FOR BOTH SELECTIONS)

Selection 6: above terminals 1 & 4; Selection 7: above terminals 3 & 6

No lamp	0				
Neon	1 125VAC	2 250VAC			
Incandescent	4 3V	5 6V	6 12V superbright	7 18V superbright	8 24V superbright
LED*					
2VDC	Red A	Amber L	Green F	Red R	
6VDC	B	M	G	S	
12VDC	C	N	H	T	
24VDC	D	P	J	V	

* Consult factory for "daylight bright" LED options. Typical current draw for LED is 20ma.

8. FLUSH BRACKET COLOR, PANEL SEAL 1

	Black	White	Gray
No Gasket	1	2	3
One Gasket	4	5	6

9. HARD SURFACE ACTUATOR

Contura X	Black	Gray	Red	White
	1	2	3	4

Actuator orientation over terminals:



10. LENS - ABOVE LAMP #2 TERMINALS 5

Z - No Lens	Clear	White	Amber	Green	Red	Blue	Lens Style
3	8	D	J	P	V		Bar
4	9	E	K	R	W		One piece Square
5	A	F	L	S	Y		Two piece Square* (with clear top protective lens)
2	7	C	H	N	U		Two piece Square* (with smoke top protective lens)
1	6	B	G	M	T		Two piece Square* (with white top protective lens)

* All bottom lenses are molded of opaque material. Consult factory for other lens colors. Lens color for LEDs must be clear, white, or match color of LED. Green or blue lenses are not recommended with Neon lamps.

12. ACTUATOR LOCK FUNCTION 3

Lock Color	Up	Down	Up & Down
Match Actuator	A	H	R
Black	B	J	S
White	C	K	T
Red	D	L	V
Gray	E	M	W
Safety Orange	F	N	Y

13. ACTUATOR LENS OR BODY LEGENDS 2

00 - No Legend				
21	22	23	24	
	OFF	ON	O	I
25	O	26	O	28
	F	N		
	F			

For additional legend options & codes, visit us at www.carlingtech.com

14. LEGEND ORIENTATION 3

- No legend (used with codes 11-18 in selection 12)
- Orientation 1
- Orientation 2
- Orientation 3
- Orientation 4

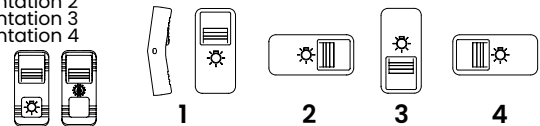

Configure Complete Part Number >

Browse Standard Parts >

Dimensional Specs

inches [millimeters]

CONTURA X

SHOWN WITH RAISED BRACKET

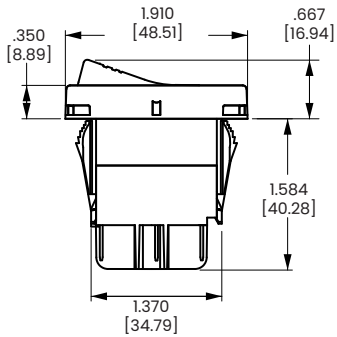
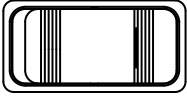

8 TERMINAL BASE
W/BARRIERS

CONTURA XI

SHOWN WITH RAISED
BRACKET AND TWO SQUARE
LENSES

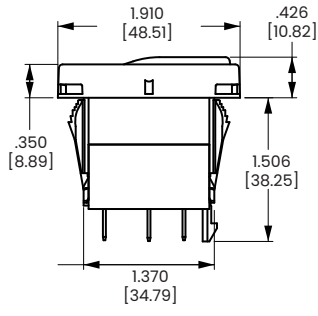
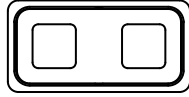

10 TERMINAL BASE
W/O BARRIERS

CONTURA XII

SHOWN WITH PADDLE
ACTUATOR

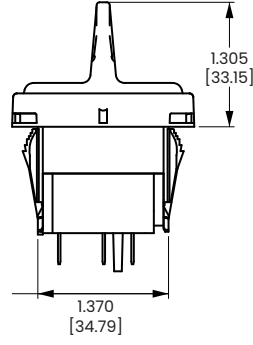
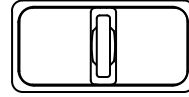

8 TERMINAL BASE
W/O BARRIERS

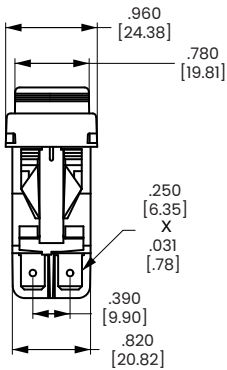

8 TERMINAL BASE
W/BARRIERS

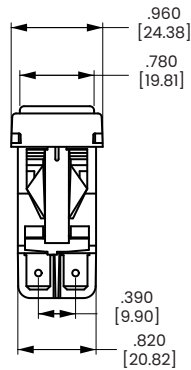

10 TERMINAL BASE
W/O BARRIERS

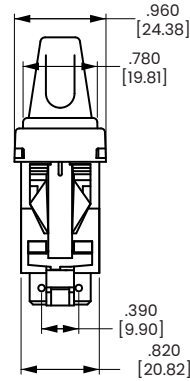

10 TERMINAL BASE
W/O BARRIERS

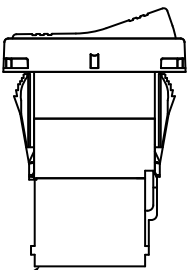

SWITCH SHOWN WITH
VCH CONNECTOR
8 TERMINAL

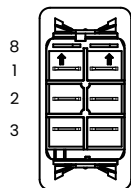

BOTTOM WITH TERMINAL
ARRANGEMENT
8 TERMINAL BASE

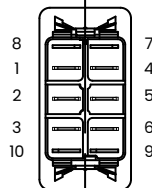

BOTTOM WITH TERMINAL
ARRANGEMENT
10 TERMINAL BASE

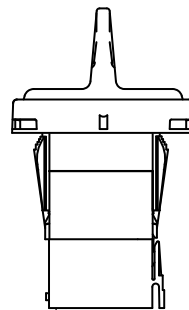

SWITCHES SHOWN WITH
VCI CONNECTOR
10 TERMINAL

Circuit Diagrams:

CIRCUIT CODE	CIRCUIT DIAGRAM
1	
2	
3	
4	
5	
6	
7	
8	

CIRCUIT CODE	CIRCUIT DIAGRAM
A	
B	
C	
D	
E	
F	
G	
H	

CIRCUIT CODE	CIRCUIT DIAGRAM
J	
K	
L	
M	
R	
S	

SYMBOL LEGEND	
SYM.	DEFINITION
○	DESIGNATES TERMINALS AND CONTACTS
—○	DESIGNATES MAINTAINED CIRCUITS
- -	DESIGNATES OTHER POSITION
—○	DESIGNATES MOMENTARY CIRCUITS
—○—○	DESIGNATES TWO POSITION CONNECTION
—	DESIGNATES EXTERNAL JUMPER PROVIDED BY CUSTOMER

Lamp Circuit Diagrams:

LAMP CIRCUIT CODE	CIRCUIT DIAGRAM	LAMP CIRCUIT CODE	CIRCUIT DIAGRAM	LAMP CIRCUIT CODE	CIRCUIT DIAGRAM	LAMP CIRCUIT CODE	CIRCUIT DIAGRAM
A / 1		F / 6		L / 9		SPECIAL #1	
B / 2		G / 7		M / R		SPECIAL #3	
C / 3		H / Z		N / T		SPECIAL #4	
D / 4		J / 8		P / V			
E / 5		K / W		U / Y			

J-Series Hazard Warning Circuit Diagrams:

CIRCUIT CODE	CIRCUIT DIAGRAM	CIRCUIT CODE	CIRCUIT DIAGRAM
J1		J5	
J2		JA	
J3		JJ	
J4		JK	

NOTE:
J circuits are available for all non-locking V-Series styles. Consult factory for partnumber details.

SYMBOL LEGEND	
SYM.	DEFINITION
○	DESIGNATES TERMINALS AND CONTACTS
○	DESIGNATES LAMP LOCATION

Stand-Alone Components

Reduce inventory levels and cost by stocking actuators and base switches separately.

Contura II, III, IV, V, VI, VII, X, XI, XII, XIV Base switches separately: specify V with code selections 2-8 in the ordering schemes.

Contura II, III, IV, V Actuator only: VV with code A or C for selection 9, & with selections 10-14 in the ordering schemes.

Contura VI Actuator with lenses and inserts only: VT with code selections 9-16

Contura II, III, IV, V, VII Actuator only: VV with code A, C, E, G, P or Z for selection 9 & with selections 10-14 in the ordering schemes.

Contura X, XI, XII, XIV actuators with lenses separately: VV with code selections 9-14 in the ordering schemes.

Panel Seal: VPS

Contura X & XI actuators without lenses separately

VVR 6 1 00 1

1 2 3 4 5

1. CONTURA X & XI ACTUATOR SEPARATELY

VVR

2. ACTUATOR STYLE & COLOR

	Black	Gray	White	Red
Contura X	1	2	3	4
Contura XI	6	7	8	9

3. LENS OPENING FOR 1

1	One bar lens			
2	Two bar lenses			
3	One square lens			
4	Two square lens			
		5	square lens on top/ bar lens on bottom (Contura X only)	

4. ACTUATOR LENS OR BODY LEGEND

00 - No Legend this location

11	ON	12	OFF	13	I	14	O	
				OFF	ON		O	I
15	O	16	O	17	O	18	I	O
	F		N		F			

For additional legend options & code, visit us at www.carlingtech.com

5. LEGEND ORIENTATION 1

0	No legend				
1	Orientation 1				
2	Orientation 2				
3	Orientation 3				
4	Orientation 4				

Contura X, XI & XII top piece of 2-piece lens separately

VVT 1

1 2

1 TOP OF LENS SEPARATELY

VVT

2 COLOR

1 Clear 2 Smoke 3 White

Contura X, XI & XII actuator lens assembly:



1 piece lens/bar lens are positioned the same as bottom lens for assembly, minus the top lens. Lenses snap in from bottom.

Notes:

- If actuator lens opening for 2 bar or 2 square lenses, legend orientation 0,1, or 2 must be chosen.
- Center of actuator marking not available for Contura XII.
- Legend is not available for bar style lens.
- Not recommended with neon lamps.
- Must also order top piece of 2 piece square lens separately.

Contura XII actuators without lenses separately

VVP J 1 Z 21 1 00

1 2 3 4 5 6 7

1 CONTURA XII ACTUATOR SEPARATELY

VVP

2. ACTUATOR STYLE & COLOR

J Black K Gray N White M Red

3,4 LENS OPENING FOR 1

Z No lens 1 Bar lens 2 Square lens

5, 7 LENS OR BODY LEGEND 2

00	- No Legend	21	OFF	22	ON	23	O	24	I
		25	O	26	O	27	O	28	I
			F		N				
			F						

For additional legend options & codes, visit us at www.carlingtech.com

6 LEGEND ORIENTATION 3

0 No legend
1 Orientation 1
2 Orientation 2

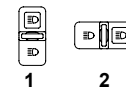

Contura X, XI & XII actuator lens assembly separately

VVL 2 1 00 0

1 2 3 4 5

1 CONTURA X, XI & XII LENS SEPARATELY

VVL

2 LENS STYLE 3

1 Bar lens
2 One Piece Square lens
3 Bottom of Two-Piece Square lens⁵

3 TRANSLUCENT LENS COLOR

1 Clear 2 White 3 Amber 4 Green⁴ 5 Red 6 Blue⁴

4 LENS OR BODY LEGEND 2

00	- No Legend	21	OFF	22	ON	23	O	24	I
		25	O	26	O	27	O	28	I
			F		N				
			F						

For additional legend options & codes, visit us at www.carlingtech.com.

5 LEGEND ORIENTATION 3

0 No legend
1 Orientation 1
2 Orientation 2
3 Orientation 3
4 Orientation 4

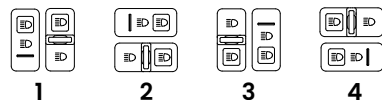

Accessories

Easily integrate Contura products into your system, with Contura Accessories

Contura Connectors



Q.C. SELECTION GUIDE						
COMPANY SERIES	PART NO		WIRE RANGE		ORIENTATION	
	PLAIN BRASS	TIN PLATED BRASS	AWG	MM ² (REF)		
PACKARD 58 SERIES	02965580		12	3.0	B	
	02965471	12010601	(2)16-14	(2)1.0-2.0		
	02965470		16-14	1.0-2.0		
	02965469	06288318	20-18	.5-.8		
PACKARD METRI-PACK 630 SERIES		12084590	105.0		A	
		12052224	123.0			
		12015870	16-14	1.0-2.0		
		12020035	(2)22-18	(2).5-.8		
		12015832	12015869	20-18		.5-.8
		12052222	20-22	.35-.5		
AMP 250 SERIES FASTIN-FASTON	60253-1	60253-2	16-12	1.3-3	B	
	42100-1	42100-2	18-14	.8-2		
	60295-1	60295-2	22-18	.3-9		

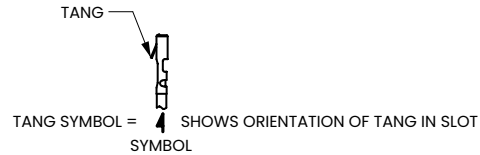

NOTE: Consult Delphi Packard and/or Amp on actual part numbers and availability. AMP is a registered trademark of AMP Inc. Harrisburg, PA. Delphi Packard is a registered trademark of Delphi-Packard Electrical Systems Warr

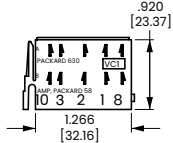
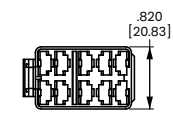

VC1 CONNECTOR HOUSING

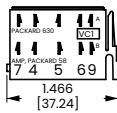

MARKING DETAIL REAR VIEW

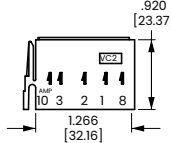
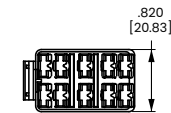

VC2 CONNECTOR HOUSING (For AMP terminals only)

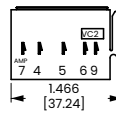

MARKING DETAIL REAR VIEW

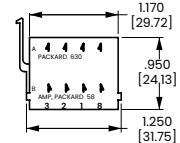
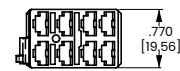

VCH CONNECTOR HOUSING

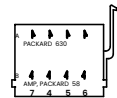

MARKING DETAIL REAR VIEW

Contura X Boot (P/N VB1-01)

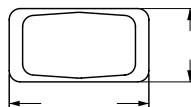

Contura II, III, IV, V, VI & VII Actuator Removal Tool (P/N VRT)

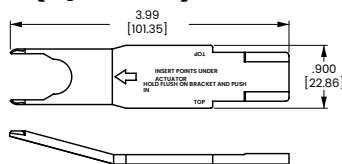

Additional V-Series Ratings

- 1 .4VA @ 28VDC Resistive
- 4 10A 250VAC 1/2 HP, 15A 125 VAC 1/2 HP, No Agency Listings
- 5¹ 10A 250VAC 1/2 HP, 15A 125 VAC 1/2 HP, UL Recognized, CSA Certified
- B 15A 24V
- C 20A 18V
- D 20A 12V
- E 20A 14V, 10A 14VT (circuits 1, 4, A, & D only)
- F 10A 14V, 6A, 14VT (circuit G only)
- G 20A 6V
- H 20A 3V
- L² 15A 125 VAC, 10A 250VAC, 1/2 HP 125-250 VAC; 6A 125 VAC L
- M .4VA/20A 12V (combi-contact) (combination gold/silver contacts for borderline dry circuit applications)
- N .4VA/15A 24V (combi-contact) (combination gold/silver contacts for borderline dry circuit applications)

NOTES

Consult factory to determine availability for individual circuits and their HP rating.

1. Not available with Contura 7 or 14 rocker styles.
2. Rating L available with circuits 1, 4, A & D only.

Accessories

Contura Mounting Panels Dimensional Specifications: in. [mm]

MOUNTING PANEL
For additional units, add 1.03 [26.2] per unit. For more than 2 V-Series Switches, add middle section. Available in panel Thicknesses listed below. Consult factory.

MOUNTING PANEL THICKNESS	
.62	.87
[15.7]	[21.9]
.98	.250
[24.8]	[6.35]
.25	.375
[6.35]	[9.52]

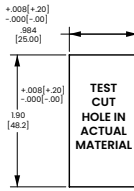

VMS MOUNTING PANEL HOLE

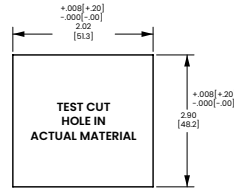

MOUNTING PANEL OPENING (2) UNITS

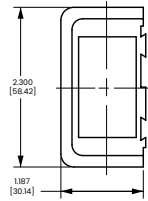

VME MOUNTING PANEL END

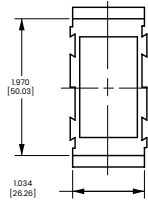

VMM MOUNTING PANEL MIDDLE

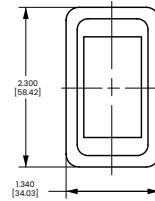

VMS MOUNTING PANEL

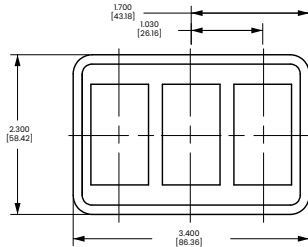

VM3 MOUNTING PANEL

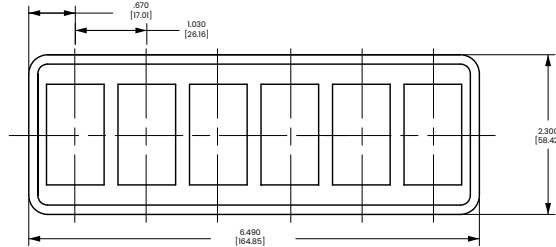

VM6 MOUNTING PANEL



Contura Hole Plug Dimensional Specifications: in. [mm]

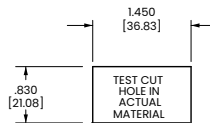

VHP CONTURA II,III HOLE PLUG

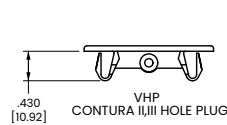

VHP CONTURA II,III HOLE PLUG

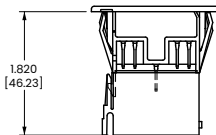

VHI STANDARD HOLE PLUG (No wing serrations) (With VC1 connector attached)

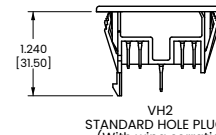

VH2 STANDARD HOLE PLUG (With wing serrations)

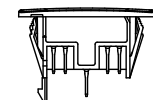
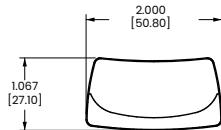

VH3 CONTURA IV HOLE PLUG (No wing serrations)

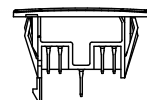

VH4 CONTURA IV HOLE PLUG (With wing serrations)



DETAIL VIEW VH1, VH3 & VH5 HOLE PLUGS (No wing serrations for ease of removal)

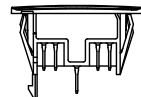
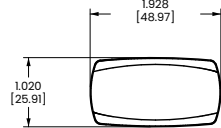

VH5 CONTURA V HOLE PLUG (No wing serrations)

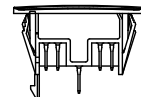

VH6 CONTURA V HOLE PLUG (With wing serrations)



DETAIL VIEW VH2, VH4 & VH6 HOLE PLUGS (With wing serrations)

Authorized Sales Representatives and Distributors

Click on a region of the map below to find your local representatives and distributors or visit www.carlingtech.com/findarep.



About Carling

Founded in 1920, Carling Technologies is a leading manufacturer of electrical and electronic switches and assemblies, circuit breakers, electronic controls, power distribution units, and multiplexed power distribution systems. With six ISO9001 and IATF16949 registered manufacturing facilities and technical sales offices worldwide, Carling Technologies Sales, Service and Engineering teams do much more than manufacture electrical components, they engineer powerful solutions! To learn more about Carling please visit www.carlingtech.com/company-profile.

To view all of Carling's environmental, quality, health & safety certifications please visit www.carlingtech.com/environmental-certifications.

© Carling Technologies, Inc.

Carling, Contura are registered trademarks of Carling Technologies, Inc. in the U.S. and other countries.