

Combo D[®] - Coaxial/50 Ohm

Right Angle Receptacle for PCB Mounting (Board Thickness Up to .125 [3.18])

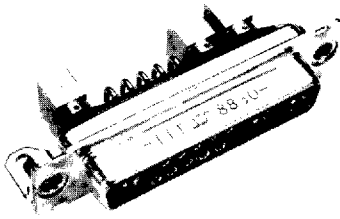

PCB Layouts - Pages 32-33

Part numbers come complete with fixed, female, signal and coaxial contacts and right angle brackets.

For tin PC tails add - A220.

D Size Connectors are mounted upside down (see diagram on page 33)

| Contact Finish Compliant Boardlock | Gold Over Ni No | Gold Over Ni Yes | 30μ in. Gold No | 30μ in. Gold Yes |
|---------------------------------------|--------------------|---------------------|--------------------|---------------------|
| DE-5W1 | DEMP5X1SJA197 | DEMC5X1SJA197 | DEMP5X1SJK126 | DEMC5X1SJK126 |
| DA-7W2 | DAMP7X2SJA197 | DAMC7X2SJA197 | DAMP7X2SJK126 | DAMC7X2SJK126 |
| DA-11W1 | DAMP11X1SJA197 | DAMC11X1SJA197 | DAMP11X1SJK126 | DAMC11X1SJK126 |
| DA-3W3 | DAMP3X3SJA197 | DAMC3X3SJA197 | DAMP3X3SJK126 | DAMC3X3SJK126 |
| DB-5W5 | DBMP5X5SJA197 | DBMC5X5SJA197 | DBMP5X5SJK126 | DBMC5X5SJK126 |
| DB-9W4 | DBMP9X4SJA197 | DBMC9X4SJA197 | DBMP9X4SJK126 | DBMC9X4SJK126 |
| DB-13W3 | DBMP13X3SJA197 | DBMC13X3SJA197 | DBMP13X3SJK126 | DBMC13X3SJK126 |
| DB-17W2 | DBMP17X2SJA197 | DBMC17X2SJA197 | DBMP17X2SJK126 | DBMC17X2SJK126 |
| DB-21W1 | DBMP21X1SJA197 | DBMC21X1SJA197 | DBMP21X1SJK126 | DBMC21X1SJK126 |
| DC-8W8 | DCMP8X8SJA197 | DCMC8X8SJA197 | DCMP8X8SJK126 | DCMC8X8SJK126 |
| DC-13W6 | DCMP13X6SJA197 | DCMC13X6SJA197 | DCMP13X6SJK126 | DCMC13X6SJK126 |
| DC-17W5 | DCMP17X5SJA197 | DCMC17X5SJA197 | DCMP17X5SJK126 | DCMC17X5SJK126 |
| DC-21WA4 | DCMP21XA4SJA197 | DCMC21XA4SJA197 | DCMP21XA4SJK126 | DCMC21XA4SJK126 |
| DC-25W3 | DCMP25X3SJA197 | DCMC25X3SJA197 | DCMP25X3SJK126 | DCMC25X3SJK126 |
| DC-27W2 | DCMP27X2SJA197 | DCMC27X2SJA197 | DCMP27X2SJK126 | DCMC27X2SJK126 |
| DD-24W7 | DDMP24X7SJA197 | DDMC24X7SJA197 | DDMP24X7SJK126 | DDMC24X7SJK126 |
| DD-36W4 | DDMP36X4SJA197 | DDMC36X4SJA197 | DDMP36X4SJK126 | DDMC36X4SJK126 |
| DD-43W2 | DDMP43X2SJA197 | DDMC43X2SJA197 | DDMP43X2SJK126 | DDMC43X2SJK126 |
| DD-47W1 | DDMP47X1SJA197 | DDMC47X1SJA197 | DDMP47X1SJK126 | DDMC47X1SJK126 |

Highlighted part numbers indicate standard product; usually available with shorter lead times.

Dimensions

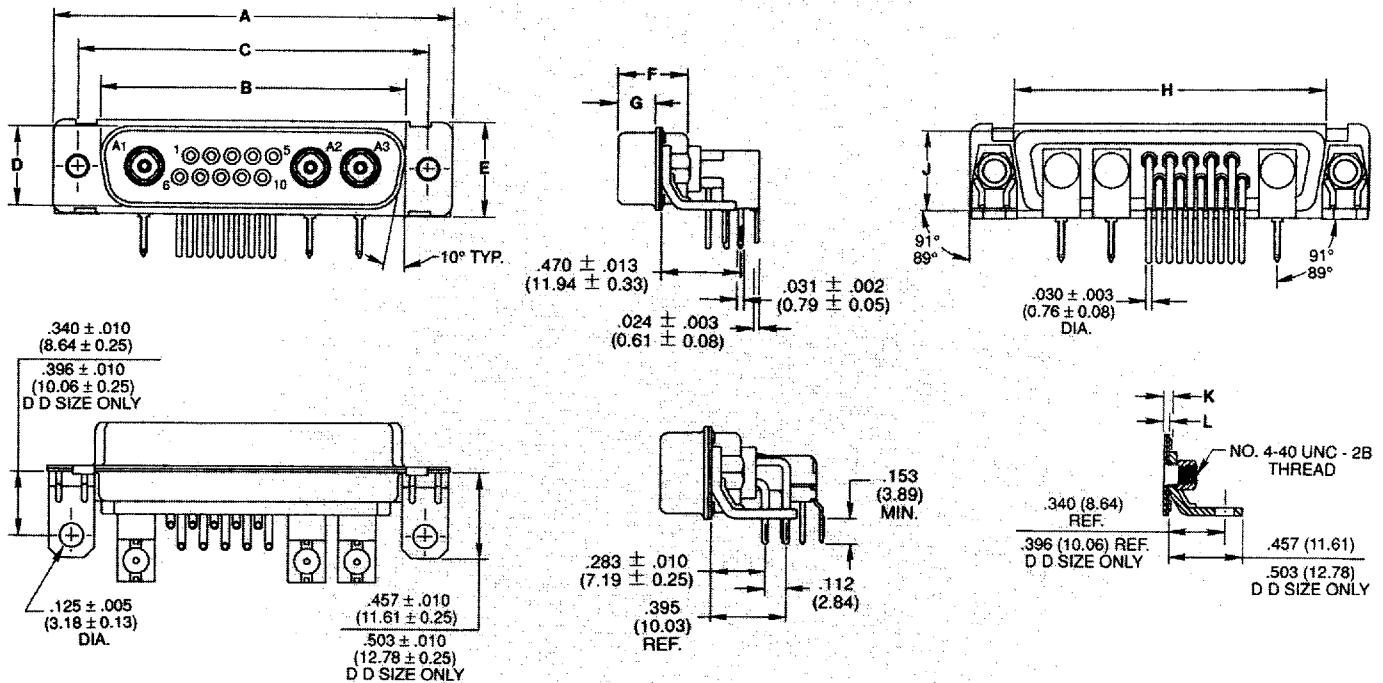

Socket Connector Assembly (Female)

| Shell Size | A ±.015 (0.38) | B ±.010 (0.25) | C ±.005 (0.13) | D ±.010 (0.25) | E ±.015 (0.38) | F Max. | G ±.010 (0.25) | H Max. | J Max. | K Max. | L ±.010 (0.25) |
|------------|-------------------|-------------------|-------------------|-------------------|-------------------|--------------|-------------------|---------------|--------------|-------------|-------------------|
| DE | 1.213 (30.81) | .642 (16.31) | .984 (24.99) | .310 (7.87) | .494 (12.55) | .429 (10.90) | .242 (6.15) | .759 (19.28) | .422 (10.72) | .075 (1.90) | .032 (0.81) |
| DA | 1.541 (39.14) | .970 (24.64) | 1.312 (33.32) | .310 (7.87) | .494 (12.55) | .429 (10.90) | .242 (6.15) | 1.083 (27.51) | .422 (10.72) | .075 (1.90) | .032 (0.81) |
| DB | 2.088 (53.03) | 1.510 (38.35) | 1.852 (47.04) | .310 (7.87) | .494 (12.55) | .429 (10.90) | .242 (6.15) | 1.625 (41.27) | .422 (10.72) | .075 (1.90) | .032 (0.81) |
| DC | 2.729 (69.31) | 2.158 (54.81) | 2.500 (63.50) | .310 (7.87) | .494 (12.55) | .429 (10.90) | .242 (6.15) | 2.272 (57.71) | .422 (10.72) | .075 (1.90) | .032 (0.81) |
| DD | 2.635 (66.93) | 2.063 (52.40) | 2.406 (61.11) | .422 (10.72) | .605 (15.37) | .429 (10.90) | .242 (6.15) | 2.178 (55.32) | .534 (13.56) | .075 (1.90) | .032 (0.81) |



For technical assistance, price or delivery information, call your local technical sales office or distributor.

Dimensions are shown in inches (millimeters).
Dimensions subject to change.

Combination D Subminiature connectors are the fastest growing segment of the D Subminiature market. ITT Cannon engineering teams, in keeping pace with the demands of the industry, have developed the broadest selection of Combination D Subminiatures available.

We offer the ability to integrate signal and 50 and 75 ohm coax, high power, and high voltage. You can mix red, green, and blue video lines with signal and up to 40 amps of power in the same package.

Design variations of the new Combo D connector, versus other packaging methods, include the proven ITT Cannon polarized "D" shape to prevent mismatching; dense, space-saving packaging; and diverse mounting options. Choose from a variety of cable and printed wiring board selections. Printed wiring board combos come pre-assembled with fixed contacts eliminating the need to buy several components.

This new line of connectors offers you **unlimited design versatility**.

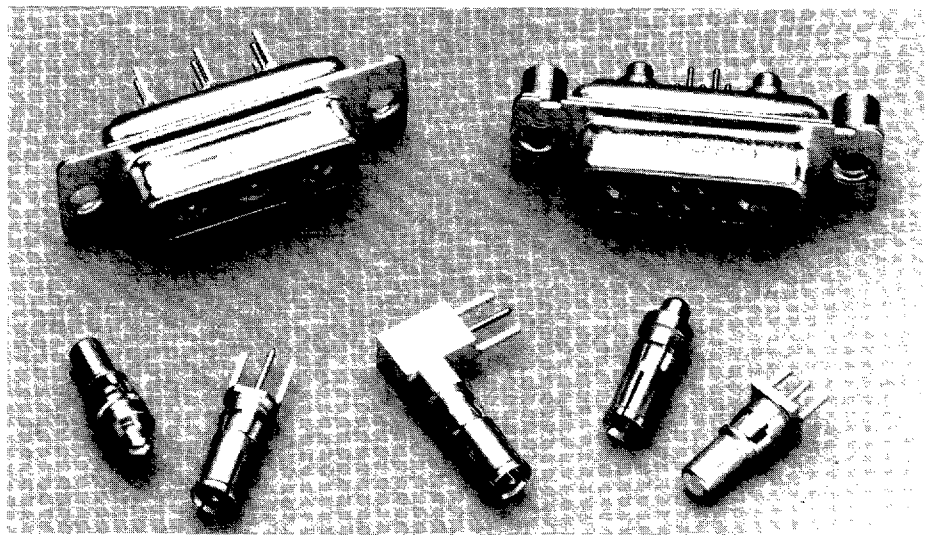

Straight and right angle printed wiring board contacts are available in both coax and high power versions.

Performance and Material Specifications

Connector Assemblies

| Description | Material | Finish |
|----------------------------------|---|---|
| Shell | Steel | Tin |
| Insulator | Thermoplastic or Diallyl Phthalate, UL 94V-0 rated. | None |
| Size 20 contacts when applicable | Copper alloy | Gold over nickel or 30μ inches, gold over nickel. |
| Standoff | Copper alloy | Electrodeposited Tin/Lead over Copper |
| Bracket | Steel | |
| Rivnut | Steel or Copper alloy | Electrodeposited Tin/Lead over Copper. |
| Eyelet | Copper alloy | |

Coaxial Assembly

| | | |
|---------------------|--------------|--|
| Contacts and shells | Copper alloy | Gold over nickel or 50μ inches gold over copper. |
| Ring, retaining | Copper alloy | Nickel |
| Insulator | Teflon | None |

U.L. File Number: E8572

Performance Data

| | |
|--|---------------------------------------|
| Signal Contact Current Rating | 5 Amp |
| Temperature Rating | -65°C to +150°C |
| Signal Contact Resistance millivolt max. | 55 @ 7.5 Amp test current |
| Coax Impedance | 75 or 50 ohm |
| Coax VSWR | Less than 1.3-1.0 up to 500 megahertz |
| Coax Insertion Loss | .1 db loss at 500 megahertz. |

Dielectric Withstanding Voltage

| Type of Contact | Altitude (feet/m) | | | | | | | | |
|---|-------------------|----------|-------------|----------|--------------|----------|-------------|----------|-----|
| | Sea Level | | 20,000/6096 | | 50,000/15240 | | 70,000/1336 | | |
| | 90° | Straight | 90° | Straight | 90° | Straight | 90° | Straight | |
| Center Conductor to Coaxial Shell | Average Flashover | 1200 | 1500 | 900 | 1000 | 600 | 700 | 400 | 500 |
| | Test | 800 | 1000 | 600 | 650 | 400 | 475 | 275 | 325 |
| Coaxial Shell to Nearest Standard Solder Pot Contact | Average Flashover | ● | 1500 | ● | 1500 | ● | 900 | ● | 650 |
| | Test | ● | 1000 | ● | 1000 | ● | 600 | ● | 425 |
| High Power contact and/or Coaxial Shell to Plug Shell | Average Flashover | 1500 | 1500 | 1000 | 1000 | 500 | 500 | 500 | 500 |
| | Test | 1000 | 1000 | 650 | 650 | 325 | 325 | 325 | 325 |
| #20 Signal | Average Flashover | 1700 | | 1000 | | 650 | | 500 | |
| | Test | 1250 | | 750 | | 475 | | 375 | |
| HV Contact to Nearest Contact or to Shell | Average Flashover | 3800 | 3800 | 2300 | 2300 | 900 | 900 | 650 | 650 |
| | Test | 2800 | 2800 | 1700 | 1700 | 675 | 675 | 475 | 475 |

All voltage figures are rms AC 60 rms cps, measured at approximately +25°C, 50% rh.

Impedance: 50 ohm, 75 ohm

Right Angle Printed Circuit Board Hole Pattern

Face view, pin insert
(for receptacle, hole pattern is a mirror image)

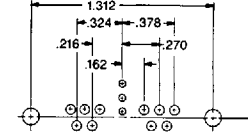
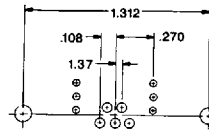
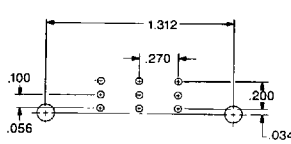
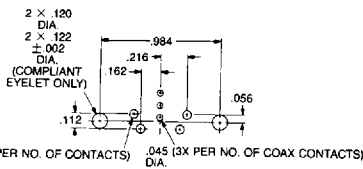

Shell Size **E**
Contact Arrangement **5W1**
No. of Signal Contacts **4 #20**
No. of Coaxial Contacts **1**

A
3W3
0
3

A
7W2
5 #20
2

A
11W1
10 #20
1

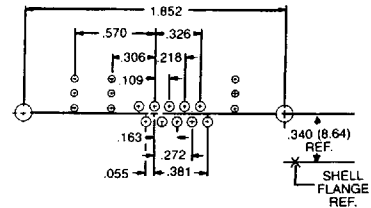
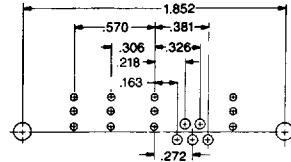
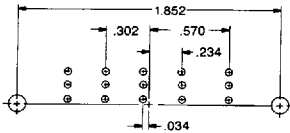

Shell Size **B**
Contact Arrangement **5W5**
No. of Signal Contacts **0**
No. of Coaxial Contacts **5**

B
9W4
5 #20
4

B
13W3
10 #20
3

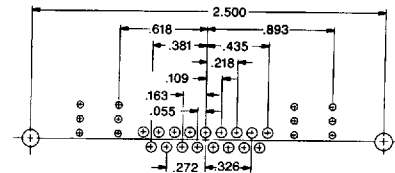
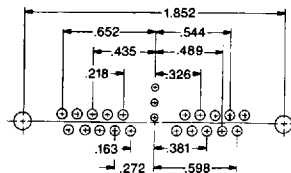
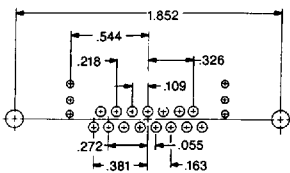

Shell Size **B**
Contact Arrangement **17W2**
No. of Signal Contacts **15 #20**
No. of Coaxial Contacts **2**

B
17W2
15 #20
2

B
21W1
20 #20
1

C
21WA4
17 #20
4

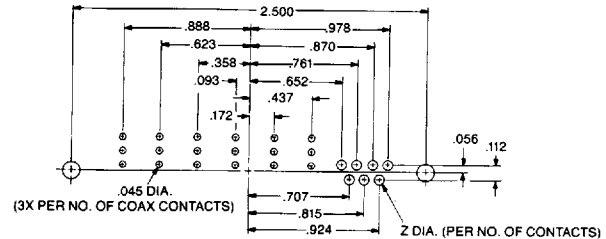
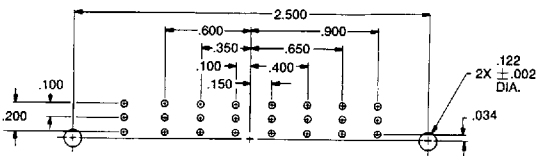

Shell Size **C**
Contact Arrangement **8W8**
No. of Signal Contacts **0**
No. of Coaxial Contacts **8**

C
8W8
0
8

C
13W6
7 #20
6

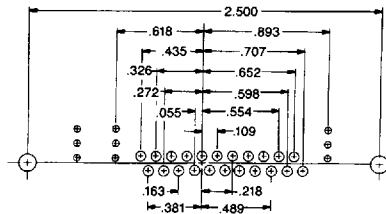
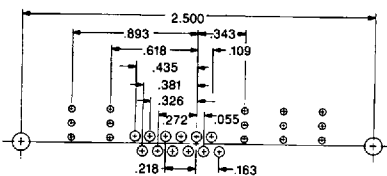

Shell Size **C**
Contact Arrangement **17W5**
No. of Signal Contacts **12 #20**
No. of Coaxial Contacts **5**

C
17W5
12 #20
5

C
25W3
22 #20
3

| Size #20 Contact PC Tail Dia. | Z Dia. |
|-------------------------------------|-------------|
| .030 (0.76) | .045 (1.14) |

Combo D[®] - Coaxial

Right Angle Printed Circuit Board Hole Patterns

Face view, pin insert
(for receptacle, hole pattern is a mirror image)

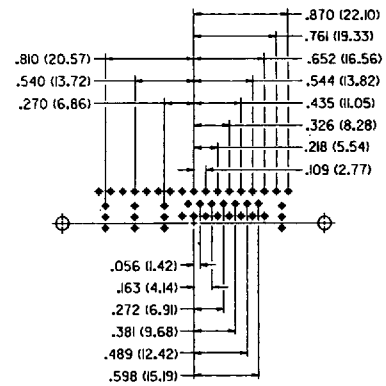
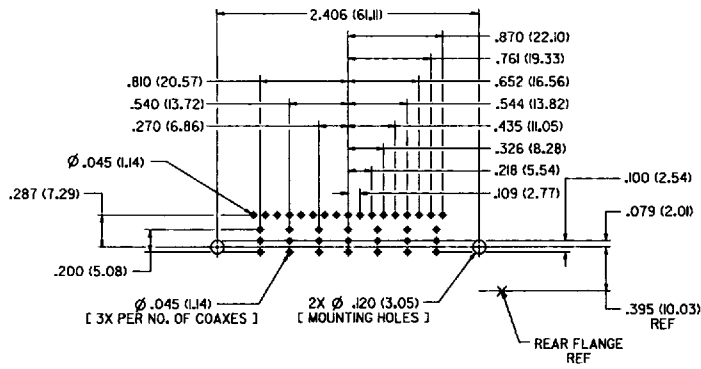

Shell Size
Contact Arrangement
No. of Signal Contacts
No. of Coaxial Contacts

D
24W7
17 #20
7

D
36W4
32 #20
4

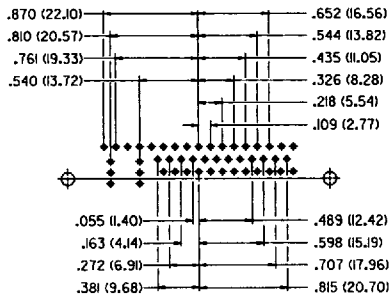

Shell Size
Contact Arrangement
No. of Signal Contacts
No. of Coaxial Contacts

D
43W2
41 #20
2

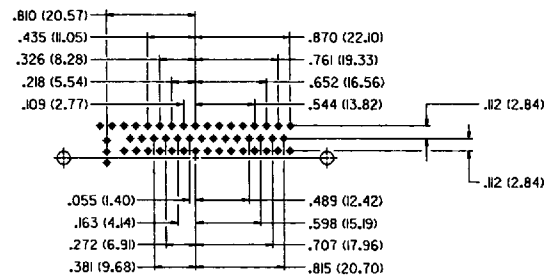

D
47W1
46 #20
1

Right Angle Coax Layouts - D Size

NOTE: Mounting is upside down.

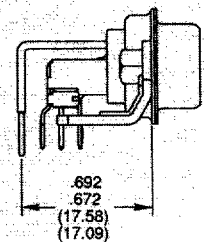
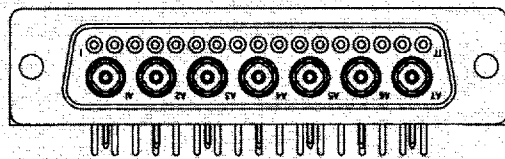

ITT Cannon

For technical assistance, price or delivery information, call your local technical sales office or distributor.

Dimensions are shown in inches (millimeters).
Dimensions subject to change.

Coaxial Housing With Solder Cup Signal Contacts

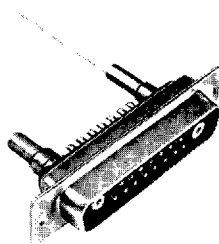

- Cable combinations supplied with preloaded solder signal contacts
- 50 ohm coax contacts supplied separately (see pages 27-28)
- 75 ohm coax contacts supplied separately (see page 23)

Clinch Nut and Float Mount Options Available:

Add: E = 4-40 Clinch Nut

Y = Float Mounting

Example: DAME3W3PK87

DAMY3W3PK87

Mounting Method Detail – Page 6.

| Layout | Standard Socket | 30 μ in. Gold Socket | Standard Pin | 30 μ in. Gold Pin |
|----------|-----------------|--------------------------|--------------|-----------------------|
| DE-5W1 | DEM5W1SA197 | DEM5W1SK126 | DEM5W1PK87 | DEM5W1PK127 |
| DA-7W2 | DAM7W2SA197 | DAM7W2SK126 | DAM7W2PK87 | DAM7W2PK127 |
| DA-11W1 | DAM11W1SA197 | DAM11W1SK126 | DAM11W1PK87 | DAM11W1PK127 |
| DA-3W3 | DAM3W3SA197 | DAM3W3SK126 | DAM3W3PK87 | DAM3W3PK127 |
| DB-5W5 | DBM5W5SA197 | DBM5W5SK126 | DBM5W5PK87 | DBM5W5PK127 |
| DB-9W4 | DBM9W4SA197 | DBM9W4SK126 | DBM9W4PK87 | DBM9W4PK127 |
| DB-13W3 | DBM13W3SA197 | DBM13W3SK126 | DBM13W3PK87 | DBM13W3PK127 |
| DB-17W2 | DBM17W2SA197 | DBM17W2SK126 | DBM17W2PK87 | DBM17W2PK127 |
| DB-21W1 | DBM21W1SA197 | DBM21W1SK126 | DBM21W1PK87 | DBM21W1PK127 |
| DC-8W8 | DCM8W8SA197 | DCM8W8SK126 | DCM8W8PK87 | DCM8W8PK127 |
| DC-13W6 | DCM13W6SA197 | DCM13W6SK126 | DCM13W6PK87 | DCM13W6PK127 |
| DC-17W5 | DCM17W5SA197 | DCM17W5SK126 | DCM17W5PK87 | DCM17W5PK127 |
| DC-21WA4 | DCM21WA4SA197 | DCM21WA4SK126 | DCM21WA4PK87 | DCM21WA4PK127 |
| DC-25W3 | DCM25W3SA197 | DCM25W3SK126 | DCM25W3PK87 | DCM25W3PK127 |
| DC-27W2 | DCM27W2SA197 | DCM27W2SK126 | DCM27W2PK87 | DCM27W2PK127 |
| DD-24W7 | DDM24W7SA197 | DDM24W7SK126 | DDM24W7PK87 | DDM24W7PK127 |
| DD-36W4 | DDM36W4SA197 | DDM36W4SK126 | DDM36W4PK87 | DDM36W4PK127 |
| DD-43W2 | DDM43W2SA197 | DDM43W2SK126 | DDM43W2PK87 | DDM43W2PK127 |
| DD-47W1 | DDM47W1SA197 | DDM47W1SK126 | DDM47W1PK87 | DDM47W1PK127 |

Highlighted part numbers indicate standard product; usually available with shorter lead times.

Contact Arrangements

(Will accommodate Removable Coax, Power and/or High Voltage Contacts)

Note: Color Code — Pin Connector: Red, Socket Connector: Blue

| | | | | | | |
|-------------------------|--------|--------|--------|--------|-----|-------|
| | | | | | | |
| Shell Size | E | A | A | A | B | B |
| Contact Arrangement | 5W1 | 3W3 | 7W2 | 11W1 | 5W5 | 9W4 |
| No. of Signal Contacts | 4 #20 | 0 | 5 #20 | 10 #20 | 0 | 5 #20 |
| No. of Coaxial Contacts | 1 | 3 | 2 | 1 | 5 | 4 |
| | | | | | | |
| Shell Size | B | B | B | B | C | C |
| Contact Arrangement | 13W3 | 17W2 | 21W1 | 8W8 | | |
| No. of Signal Contacts | 10 #20 | 15 #20 | 20 #20 | 0 | | |
| No. of Coaxial Contacts | 3 | 2 | 1 | 8 | | |
| | | | | | | |
| Shell Size | C | C | C | C | C | C |
| Contact Arrangement | 13W6 | 17W5 | 21WA4 | 25W3 | | |
| No. of Signal Contacts | 7 #20 | 12 #20 | 17 #20 | 22 #20 | | |
| No. of Coaxial Contacts | 6 | 5 | 4 | 3 | | |
| | | | | | | |
| Shell Size | C | D | D | D | D | D |
| Contact Arrangement | 27W2 | 36W4 | 43W2 | | | |
| No. of Signal Contacts | 25 #20 | 32 #20 | 41 #20 | | | |
| No. of Coaxial Contacts | 2 | 4 | 2 | | | |
| | | | | | | |
| Shell Size | D | D | D | D | D | D |
| Contact Arrangement | 24W7 | 47W1 | | | | |
| No. of Signal Contacts | 17 #20 | 46 #20 | | | | |
| No. of Coaxial Contacts | 7 | 1 | | | | |