

Product description	<b>RD24 Male cable connector, Contacts: 3+PE, 12.0-14.0 mm, unshielded, screw clamp, IP67, UL, ESTI+, VDE, PG 16</b>
Area	<b>series 693</b>
Part no.	<b>99 4221 160 04</b>

## Illustration

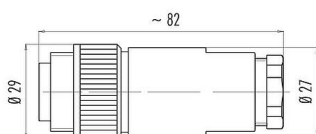

## Scale drawing



## Contact arrangement (Plug-in side)

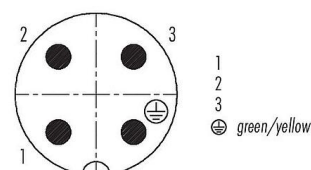

You can find the component part drawing on the next page.

## Technical data

### General features

Part no.	<b>99 4221 160 04</b>
	Alternative part no.: 99 0209 160 04
Connector design	Male cable connector
Version	Connector pin straight
Connector locking system	screw
Termination	screw clamp
Degree of protection	IP67
Connection cross-section	max. 2.50 mm <sup>2</sup> / AWG 14
Cable outlet	12.0-14.0 mm
Temperature range from/to	-40 °C / 100 °C
Mechanical operation	> 500 Mating cycles
Weight (g)	40.47
Customs tariff number	85369010
Country of Origin	DE

### Electrical parameters

Rated voltage	400 V (600 V UL)
Rated voltage UL	11768
Rated impulse voltage	6000 V
Rated current	16 A (12 A UL)
Insulation resistance	≥ 10 <sup>10</sup> Ω
Pollution degree	3
Overvoltage category	III
Insulating material group	III
EMC compliance	unshielded

# Product data sheet

## Power connectors



Product description	<b>RD24 Male cable connector, Contacts: 3+PE, 12.0-14.0 mm, unshielded, screw clamp, IP67, UL, ESTI+, VDE, PG 16</b>
Area	<b>series 693</b>
Part no.	<b>99 4221 160 04</b>

### Material

Contact body material	PBT (UL94 V-0)
Contact material	CuZn (brass)
Contact plating	Ag (silver)
REACH SVHC	CAS 96-45-7 (Imidazolidine-2-thione) CAS 7439-92-1 (Lead)
SCIP number	2632f832-8be1-4775-8fdd-f19e3d87f23d

### Authorization/approvals

Approvals	UL, ESTI+, VDE
-----------	----------------

### Classifications

eCl@ss 11.1	27-44-01-02
ETIM 9.0	EC002635

### Declarations of conformity

Low Voltage Directive	2014/35/EU (EN 60529:1991   2014/35/EU;EN 60204-1:2018)
-----------------------	---

Product description	RD24 Male cable connector, Contacts: 3+PE, 12.0-14.0 mm, unshielded, screw clamp, IP67, UL, ESTI+, VDE, PG 16
Area	series 693
Part no.	99 4221 160 04

## Derating curve

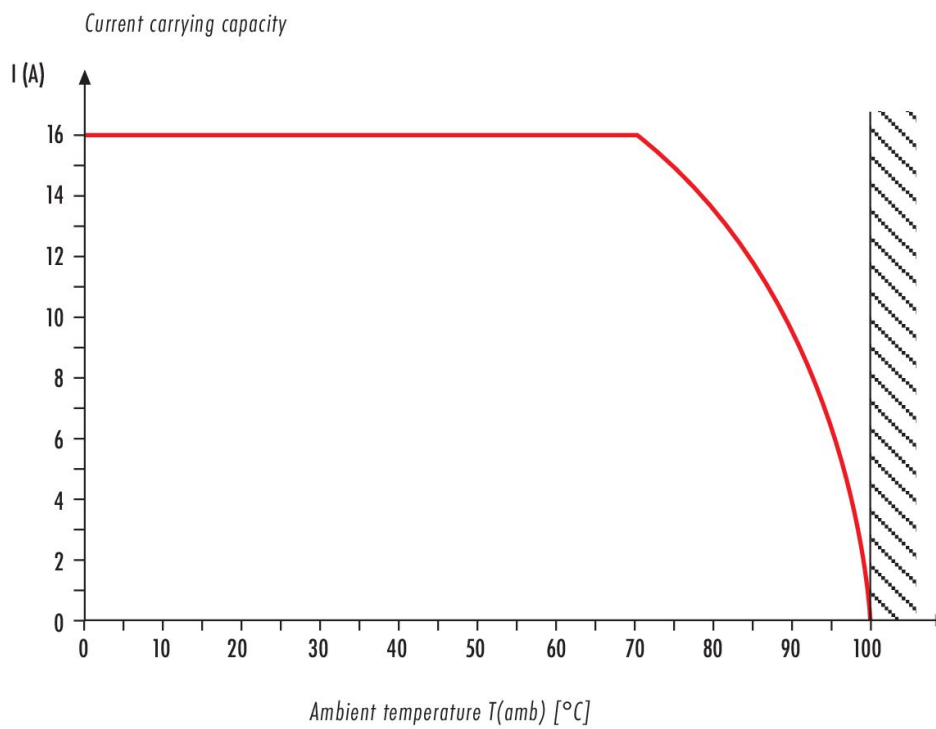

Product description **RD24 Male cable connector, Contacts: 3+PE, 12.0-14.0 mm, unshielded, screw clamp, IP67, UL, ESTI+, VDE, PG 16**

Area **series 693**  
Part no. **99 4221 160 04**

### Component part drawing

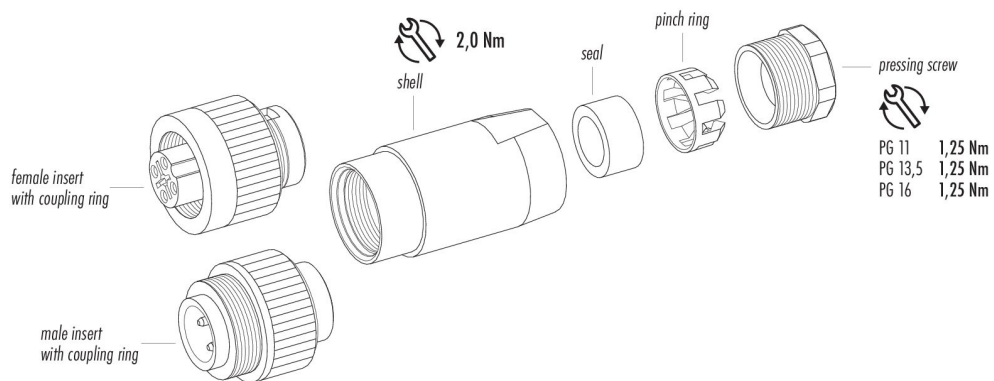

Product description	<b>RD24 Male cable connector, Contacts: 3+PE, 12.0-14.0 mm, unshielded, screw clamp, IP67, UL, ESTI+, VDE, PG 16</b>
Area	<b>series 693</b>
Part no.	<b>99 4221 160 04</b>

## Security notices

The connector must not be plugged or unplugged under load. Non-observance and improper use can result in personal injury.

The connectors have been developed for applications in plant engineering, control and electrical equipment construction. The user is responsible for checking whether the connectors can also be used in other areas of application.

To protect against unintentional opening of the connector, the thread between the housing and the connector head must be secured with a suitable cyanoacrylate adhesive when used in circuits with voltages dangerous to the touch. This does not apply to connectors used in SELV and PELV circuits according to IEC 61140 (EN 61140, VDE 0140-1).

Connectors which are used in circuits with voltages dangerous to the touch may only be installed and used by, or under the supervision of, persons with electrical engineering training, taking into account the applicable regulations and standards.

The user must take suitable safety precautions to ensure that the connector cannot be accidentally disconnected.

Please observe the pollution degree and the overvoltage category. For further information, please refer to the download center "Technical Information".

## DECLARATION FROM THE MANUFACTURER

For part no.: 99 4221 160 04

14/07/2025

With regard to the

**Regulation (EC) No 1907/2006 of the European Parliament and of the Council of 18 December 2006 concerning the Registration, Evaluation, Authorisation and Restriction of Chemicals (REACH), establishing a European Chemicals Agency, amending Directive 1999/45/EC and repealing Council Regulation (EEC) No 793/93 and Commission Regulation (EC) No 1488/94 as well as Council Directive 76/769/EEC and Commission Directives 91/155/EEC, 93/67/EEC, 93/105/EC and 2000/21/EC.**

With the REACH regulation, the EU has created a uniform system for the Registration, Evaluation, Authorisation and restriction of CHEMicals – or REACH. The purpose of this regulation is to ensure a high level of protection of human health and the environment.

Franz Binder GmbH & Co. Elektrische Bauelemente KG hereby confirms that it acts as a downstream user (producer of products) according to the aforementioned regulation.

We obtain all raw materials and/or preparations, from which the connectors are made, from suppliers who have already registered or pre-registered all substances, including those present in the preparations. The products supplied by the company are not subject to registration.

With regard to Article 33(1) of the REACH regulation, Franz Binder GmbH & Co. Elektrische Bauelemente KG complies with its information obligations:

An up-to-date candidate list (candidate list of substances of very high concern for authorisation, as of 25/06/2025 see: <https://echa.europa.eu/de/candidate-list-table>) in accordance with Article 59 (1, 10) of the regulation (EC) No 1907/2006 (REACH) has been published.

The aforementioned article includes the following substances from the up-to-date candidate list in concentrations of more than 0,1 percent by mass:

- CAS 96-45-7 (Imidazolidine-2-thione)
- CAS 7439-92-1 (Lead)

Please refer any questions to our Product Compliance Team:

[Product-Compliance@binder-connector.de](mailto:Product-Compliance@binder-connector.de)

## DECLARATION FROM THE MANUFACTURER

For part no.: 99 4221 160 04

14/07/2025

With regard to the

### COMMISSION DELEGATED DIRECTIVE (EU) 2015/863 of 31 March 2015

**amending Annex II to Directive 2011/65/EU of the European Parliament and of the Council as regards  
the list of restricted substances**

Directive 2011/65/EU stipulates provisions on the restriction of the use of hazardous substances in electrical and electronic equipment (EEE) with a view to contributing to the protection of human health and the environment, including the environmentally sound recovery and disposal of EEE waste.

#### ANNEX II

Restricted substances referred to in Article 4(1) and maximum concentration values tolerated by weight in homogeneous materials

Lead (0,1%) mercury (0,1%) cadmium (0,01%) hexavalent chromium (0,1%) polybrominated biphenyls (PBB) (0,1%) polybrominated diphenyl ethers (PBDE) (0,1%) bis(2-ethylhexyl) phthalate (DEHP) (0,1%) butyl benzyl phthalate (BBP) (0,1%) dibutyl phthalate (DBP) (0,1%) diisobutyl phthalate (DIBP) (0,1%)

Franz Binder GmbH & Co. Elektrische Bauelemente KG hereby confirms that it complies with all standard articles of the aforementioned Directive. Our products do not contain any of the specified prohibited substances above the maximum permitted concentrations specified therein, taking into account the exemptions in Annex III of Directive 2011/65/EU.

- Complies with RoHS III with exemption 6c

Please refer any questions to our Product Compliance Team:

Product-Compliance@binder-connector.de

## MANUFACTURER'S DECLARATION

For part no.: 99 4221 160 04

14/07/2025

with regard to

### Declaration of compliance with China RoHS – Components

We herewith declare the compliance of this product with the Chinese marking requirements. This product can be recycled and used safely during its environmentally friendly use period of 50 years. These articles will be sold as components only for manufacturing. According to the Electronic Industry Standard SJ/T 11364-2014 it needs not to be marked with Environmentally Friendly Use Period (EFUP) label. This product should be recycled after its environmental protection use period has expired because it may contain substances or elements as shown in the following table:

Part Name	Hazardous Substance					
	Lead (Pb)	Mercury (Hg)	Cadmium (Cd)	Hexavalent Chromium (Cr(VI))	Polybrominated biphenyls (PBB)	Polybrominated diphenyl ethers (PBDE)
Connectors	X	0	0	0	0	0

This table is prepared in accordance with the provisions of SJ/T 11364.

0: Indicates that said hazardous substance contained in all of the homogeneous materials for this part is below the limit requirement of GB/T 26572

X: Indicates that said hazardous substance contained in at least one of the homogeneous materials used for this part is above the limit requirement of GB/T 26572

The table shows where these substances may be found in this Electrical and Electronic Product.

Please refer any questions to our Product Compliance Team:

Product-Compliance@binder-connector.de

# CERTIFICATE OF COMPLIANCE

**Certificate Number** 20160930-E93427  
**Report Reference** E93427-19850211  
**Issue Date** 2016-SEPTEMBER-30

**Issued to:** FRANZ BINDER GMBH & CO. ELEKTRISCHE  
BAUELEMENTE KG  
ROETELSTRASSE 27  
74172 NECKARSULM GERMANY

**This is to certify that representative samples of** COMPONENT - CONNECTORS FOR USE IN DATA, SIGNAL, CONTROL AND POWER APPLICATIONS  
See Addendum Page

Have been investigated by UL in accordance with the Standard(s) indicated on this Certificate.

**Standard(s) for Safety:** UL 1977, Component Connectors for Use in Data, Signal, Control and Power Applications.  
CAN/CSA C22.2 No. 182.3-16.

**Additional Information:** See the UL Online Certifications Directory at [www.ul.com/database](http://www.ul.com/database) for additional information

Only those products bearing the UL Certification Mark should be considered as being covered by UL's Certification and Follow-Up Service.

The UL Recognized Component Mark generally consists of the manufacturer's identification and catalog number, model number or other product designation as specified under "Marking" for the particular Recognition as published in the appropriate UL Directory. As a supplementary means of identifying products that have been produced under UL's Component Recognition Program, UL's Recognized Component Mark: , may be used in conjunction with the required Recognized Marks. The Recognized Component Mark is required when specified in the UL Directory preceding the recognitions or under "Markings" for the individual recognitions.

Recognized components are incomplete in certain constructional features or restricted in performance capabilities and are intended for use as components of complete equipment submitted for investigation rather than for direct separate installation in the field. The final acceptance of the component is dependent upon its installation and use in complete equipment submitted to UL LLC.

Look for the UL Certification Mark on the product.



Bruce Mahrenholz, Director North American Certification Program

UL LLC

Any information and documentation involving UL Mark services are provided on behalf of UL LLC (UL) or any authorized licensee of UL. For questions, please contact a local UL Customer Service Representative at <http://ul.com/about/locations/>



# CERTIFICATE OF COMPLIANCE

**Certificate Number** 20160930-E93427  
**Report Reference** E93427-19850211  
**Issue Date** 2016-SEPTEMBER-30

This is to certify that representative samples of the product as specified on this certificate were tested according to the current UL requirements.

## Products Covered:

Receptacles, Cord Connectors, Attachment Plugs, Motor Attachment Plugs; Series 693 with Suffixes -1 through 4, incl.

### ATTACHMENT PLUGS, STRAIGHT:

Series, 693-1: 99-4221-00-04, 99-4221-14-04, 99-4221-110-04, 99-4221-160-04, 99-4221-300-04, 99-4225-00-07, 99-4225-14-07, 99-4225-110-07, 99-4225-160-07, 99-4225-300-07, 99-4217-00-07, 99-4217-14-07, 99-4217-110-07, 99-4217-160-07, 99-4217-300-07, 99-4201-00-07, 99-4201-14-07, 99-4201-110-07, 99-4201-160-07, 99-4201-300-07.

### ATTACHMENT PLUGS, ANGLE:

Series, 693-1: 99-4221-70-04, 99-4221-210-04, 99-4221-215-04, 99-4225-70-07, 99-4225-210-07, 99-4225-215-07, 99-4217-70-07, 99-4217-210-07, 99-4217-215-07, 99-4201-70-07, 99-4201-210-07, 99-4201-215-07.

### CORD CONNECTORS, STRAIGHT:

Series, 693-2: 99-4222-00-04, 99-4222-14-04, 99-4222-110-04, 99-4222-160-04, 99-4222-300-04, 99-4226-00-07, 99-4226-14-07, 99-4226-110-07, 99-4226-160-07, 99-4226-300-07, 99-4218-00-07, 99-4218-14-07, 99-4218-110-07, 99-4218-160-07, 99-4218-300-07, 99-4202-00-07, 99-4202-14-07, 99-4202-110-07, 99-4202-160-07, 99-4202-300-07.

### CORD CONNECTORS, ANGLE:

Series, 693-2: 99-4222-70-04, 99-4222-210-04, 99-4222-215-04, 99-4226-70-07, 99-4226-210-07, 99-4226-215-07, 99-4218-70-07, 99-4218-210-07, 99-4218-215-07, 99-4202-70-07, 99-4202-210-07, 99-4202-215-07.

### APPLIANCE INLET:

Series, 693-3: 09-4223-00-04, 09-4223-150-04, 09-4227-00-07, 09-4227-111-07, 09-4219-00-07, 09-4219-150-07, 09-4203-00-07.

### RECEPTACLES:

Series, 693-4: 09-4204-00-07, 09-4224-00-04, 09-4224-150-04, 09-4228-00-07, 09-4220-00-07, 09-4220-150-07.

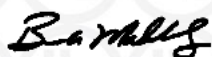

Bruce Mahrenholz, Director North American Certification Program

UL LLC

Any information and documentation involving UL Mark services are provided on behalf of UL LLC (UL) or any authorized licensee of UL. For questions, please contact a local UL Customer Service Representative at <http://ul.com/aboutul/locations/>



## EU DECLARATION OF CONFORMITY

Manufacturer	<b>Franz Binder GmbH &amp; Co. Elektrische Bauelemente KG Rötelstraße 27 D-74172 Neckarsulm</b>
Part no.	<b>99 4221 160 04</b>
Product	
Series	<b>series 693</b>

This product complies with the requirements of the following European Directive:  
Directive 2014/35/EU of the European Parliament and of the council of 26 February 2014 on the harmonisation of the laws of the Member States relating to the making available on the market of electrical equipment designed for use within certain voltage limits (recast).

The following harmonized standards have been applied for conformity assessment:

EN 60529:1991 | 2014/35/EU;EN 60204-1:2018 \*)

\*) This standard is currently not harmonized

References to standards apply to references to their amendments, if these amendments are listed to the respective directives in the Official Journal of the European Union.

This declaration of conformity is issued under the sole responsibility of the manufacturer.

Neckarsulm, 2025-03-05



i.A. Soner Cakar  
Product Compliance Manager

## UKCA DECLARATION OF CONFORMITY

Manufacturer	<b>Franz Binder GmbH &amp; Co. Elektrische Bauelemente KG Rötelstraße 27 D-74172 Neckarsulm</b>
Object of the declaration	<b>Connector (COC)</b>
Product	<b>99 4221 160 04</b>

The object of the declaration described above is in conformity with the relevant UK-Regulations and UK-Guidelines:

**The Electrical Equipment (Safety) Regulations 2016**  
STATUTORY INSTRUMENTS  
2016 No. 1101  
CONSUMER PROTECTION  
HEALTH AND SAFETY

References of standards and/ or technical specifications applied for this declaration of conformity, or parts thereof:

**2016 No. 1101: EN 61984:2009 \*)**

\*) This standard is currently not listed in the assigned directive.

This declaration is issued under the sole responsibility of the manufacturer.

Neckarsulm, 2025-03-05



i.A. Soner Cakar  
Product Compliance Manager