

Power Relays ( Over 2 A )  
**HE-R RELAYS**

Product Catalog

**IN Your  
Future**

# HE-R RELAYS

Compact size 2 Form A and 2 Form A 1 Form B 80 A/4 Form A and 4 Form A and 1 Form B 40 A power relays

Protective construction : Flux-resistant type

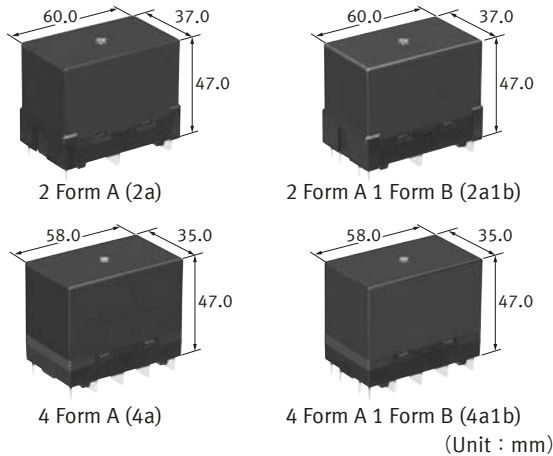

## FEATURES

- High capacity
  - 2 Form A/2 Form A 1 Form B: 70 A 277 V AC  $30 \times 10^3$  ope. Max. switching current 80 A
  - 4 Form A/4 Form A 1 Form B: 40 A 480 V AC  $30 \times 10^3$  ope. Max. switching current 50 A
- Welding detection function: Mirror contact mechanisms ( Compliant with IEC60947-4-1 )
- PCB Terminals
- Low operating power: 4.0 W ( Holding power 0.49 W )
- Contact gap: Min.3.6 mm
- Short circuit capability
  - 2 Form A/2 Form A 1 Form B:  $I_{rms} = 5$  kA ( Compliant with UL508 )
  - 4 Form A/4 Form A 1 Form B:  $I_p = 2.6$  kA  $I^2t = 6.5$  kA<sup>2</sup>s ( Compliant with IEC62955 )

## TYPICAL APPLICATIONS

- Charging Station
- Industrial equipment

## DETAILS FEATURES

### Contact gap ( initial )

Form A contact	Min. 3.6 mm each Form A contact
Form B contact	Min. 0.5 mm ( when Form A contact welded )

### UL standard short circuit capability

2a/2a1b: UL508

- $I_{rms} = 5$  kA

### The most suitable for IEC compliant charging stations

4a/4a1b: IEC61851-1, IEC62955

- Contact Gap: Min. 3.6 mm ( Initial Value )
- Electrical life: 32 A 277 V AC Min.  $50 \times 10^3$  operations
- Short circuit withstand:  $I_p = 2.6$  kA,  $I^2t = 6.5$  kA<sup>2</sup>s

### Insulation distance ( initial )

Item	2 Form A / 2 Form A 1 Form B	4 Form A / 4 Form A 1 Form B
Between Form A contact and coil	Min. 8.0 mm ( Clearance/Creepage )	
Between Form B contact and coil	Min. 3.2 mm ( Clearance/Creepage )	
Between Form A contact sets	Min. 8.0 mm ( Clearance/Creepage )	Min. 5.5 mm ( Clearance/Creepage )
Between Form A contact and Form B contact	Min. 8.0 mm ( Clearance/Creepage )	

# Power Relays ( Over 2 A ) HE-R RELAYS

## ORDERING INFORMATION ( PART NO. )

### AHER

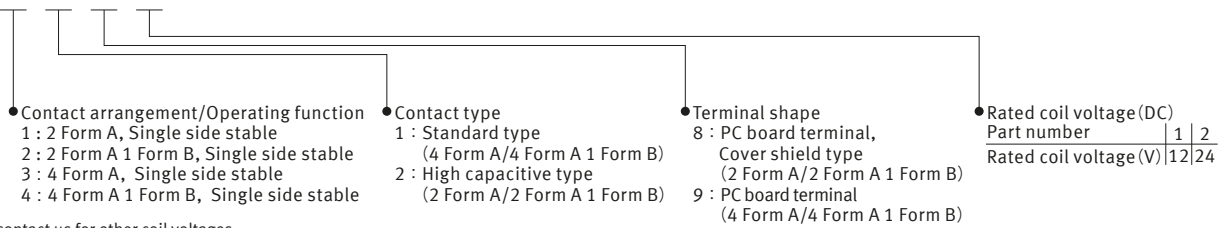

Note) Please contact us for other coil voltages.

## TYPES

### ■ PC board terminal

Contact arrangement	Rated coil voltage	Part No.	Standard packing	
			Inner carton	Outer carton
2 Form A	12 V DC	AHER1281	10 pcs.	50 pcs.
	24 V DC	AHER1282		
2 Form A 1 Form B	12 V DC	AHER2281		
	24 V DC	AHER2282		
4 Form A	12 V DC	AHER3191		
	24 V DC	AHER3192		
4 Form A 1 Form B	12 V DC	AHER4191		
	24 V DC	AHER4192		

## RATING

### ■ Coil data

- Operating characteristics such as " Operate voltage " and " Release voltage " are influenced by mounting conditions or ambient temperature, etc.  
Therefore, please use the relay within  $\pm 5\%$  of rated coil voltage.
- " Initial " means the condition of products at the time of delivery.

Rated coil voltage	Operate voltage*1 ( at 20 °C )	Release voltage*1 ( at 20 °C )	Rated operating current ( $\pm 10\%$ , at 20 °C )	Coil resistance ( $\pm 10\%$ , at 20 °C )	Rated operating power	Max. allowable voltage ( at 55 °C )
12 V DC	Max. 75 % V of rated coil voltage ( Initial )	Min. 5 % V of rated coil voltage ( Initial )	333 mA	36.0 $\Omega$	4,000 mW Holding*2: 490 mW*3	110 % V of rated coil voltage
24 V DC			167 mA	144.0 $\Omega$		

\*1: Square, pulse drive

\*2: When using with the holding voltage, switch to the holding voltage after 200 ms from the application of the coil rated voltage.

\*3: With 35 % V coil holding voltage

# Power Relays ( Over 2 A ) HE-R RELAYS

## Specifications

Item		Specifications		
Contact data	Contact arrangement	2 Form A ( 2a ) , 2 Form A 1 Form B ( 2a1b )	4 Form A ( 4a ) , 4 Form A 1 Form B ( 4a1b )	
	Form A contact	Contact resistance ( initial )	Max. 10 mΩ ( by voltage drop 20 A 6 V DC, after 3 min. ) Max. 3 mΩ ( by voltage drop 80 A 6 V DC, reference value )	Max. 10 mΩ ( by voltage drop 20 A 6 V DC after 3 min. ) Max. 3 mΩ ( by voltage drop 50 A 6 V DC, reference value )
		Contact material	AgNi type	AgSnO <sub>2</sub> type
		Contact rating ( resistive )	80 A 277 V AC	40 A 480 V AC
		Max. switching power ( resistive )	22,160 VA	19,200 VA
		Max. switching voltage	277 V AC	480 V AC
		Max. switching current	80 A	50 A
		Min. switching load ( reference value ) *1	100 mA 24 V DC	
	Form B contact ( 4a1b type only )	Contact resistance ( initial )	Max. 100 mΩ ( by voltage drop 1 A 6 V DC )	
		Contact material	Au plated AgNi type	
		Contact rating ( resistive )	0.5 A 30 V DC, 1 A 277 V AC	
		Max. switching power ( resistive )	15 W, 277 VA	
		Max. switching voltage	30 V DC, 277 V AC	
		Max. switching current	1 A	
Min. switching load ( reference value ) *1	10 mA 5 V DC			
Insulation resistance ( initial )		Min. 1,000 MΩ ( at 500 V DC, Measured portion is the same as the case of dielectric strength )		
Dielectric strength ( initial )	Between open Form A contacts	2,000 V rms for 1 min ( detection current: 10 mA )		
	Between Form A contact and coil	5,000 V rms for 1 min ( detection current: 10 mA )		
	Between Form A contact sets	5,000 V rms for 1 min ( detection current: 10 mA )		
	Between open Form B contacts	1,000 V rms for 1 min ( detection current: 10 mA )		
	Between Form B contact and coil	2,000 V rms for 1 min ( detection current: 10 mA )		
Surge withstand voltage ( initial ) *2	Between Form A contact and coil	10,000 V		
	Between Form B contact and coil	2,500 V		
Coil holding voltage*3		35 to 110 % V ( at -40 to +55°C, Form A contact: 80 A ) 35 to 50 % V ( at -40 to +85°C, Form A contact: 70 A to 80 A )	35 to 110 % V ( at -40 to +55 °C, Form A contact: 50 A ) 35 to 50 % V ( at -40 to +85 °C, Form A contact: 40 A to 50 A )	
Time characteristics ( initial )	Operate time	Max. 50 ms ( at rated coil voltage, at 20 °C, without bounce )		
	Release time*4	Max. 30 ms ( at rated coil voltage, at 20 °C, without bounce, without diode )		
Shock resistance	Functional	25 m/s <sup>2</sup> ( half-sine shock pulse: 11 ms, detection time: 10 μs )		
	Destructive	980 m/s <sup>2</sup> ( half-sine shock pulse: 6 ms )		
Vibration resistance	Functional	10 to 55 Hz ( at double amplitude of 0.3 mm, detection time: 10 μs )		
	Destructive	10 to 55 Hz ( at double amplitude of 1.5 mm )		
Expected life	Mechanical life	Min. 100 × 10 <sup>3</sup> ope. ( switching frequency: at 180 times/min )		
Conditions	Conditions for usage, transport and storage	Ambient temperature: -40 to +55 °C ( When applied coil hold voltage is 35 to 110 % V of rated coil voltage. ) -40 to +85 °C ( When applied coil hold voltage is 35 to 50 % V of rated coil voltage or storage. ) Humidity: 5 to 85 % RH ( Avoid icing and condensation )		
Unit weight		Approx. 180 g		

\*1: This value can change due to the switching frequency, environmental conditions, and desired reliability level, therefore it is recommended to check this with the actual load.

\*2: Wave is standard shock voltage of  $\pm 1.2 \times 50 \mu s$  according to JEC-212-1981

\*3: Coil holding voltage is the coil voltage after 200 ms from the applied rated coil voltage.

\*4: Release time will lengthen if a diode, etc., is connected in parallel to the coil. Be sure to verify operation under actual conditions.

# Power Relays ( Over 2 A ) HE-R RELAYS

## Expected electrical life

Conditions: Resistive load, Switching frequency: ON: OFF = 1 s: 9 s

Type	Switching capacity	Number of operations
2 Form A/ 2 Form A 1 Form B	63 A 277 V AC	Min. $50 \times 10^3$ ope.
	70 A 277 V AC	Min. $30 \times 10^3$ ope.
	80 A 277 V AC	Min. $10 \times 10^3$ ope.
	0.5 A 30 V DC	Min. $100 \times 10^3$ ope.
4 Form A/ 4 Form A 1 Form B	1 A 277 V AC	Min. $100 \times 10^3$ ope.
	32 A 277 V AC	Min. $50 \times 10^3$ ope.
	40 A 480 V AC	Min. $30 \times 10^3$ ope.
	0.5 A 30 V DC	Min. $100 \times 10^3$ ope.
1 A 277 V AC	Min. $100 \times 10^3$ ope.	

## REFERENCE DATA

1-1. Max. switching capacity  
( 2 Form A/2 Form A 1 Form B )

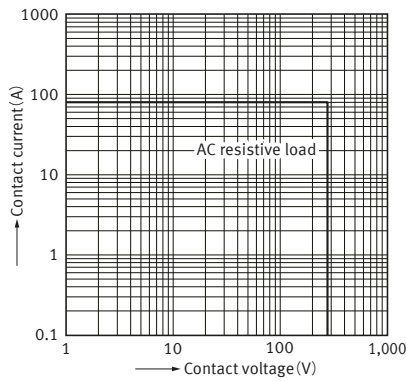

1-2. Max. switching capacity  
( 4 Form A/4 Form A 1 Form B )

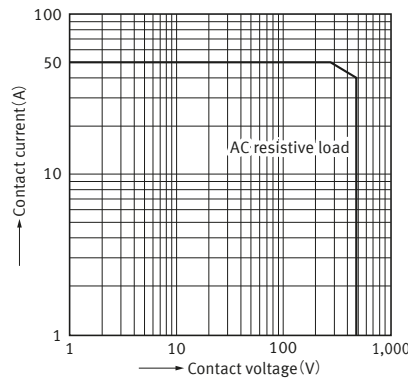

2-1. Switching life curve  
( 2 Form A/2 Form A 1 Form B )

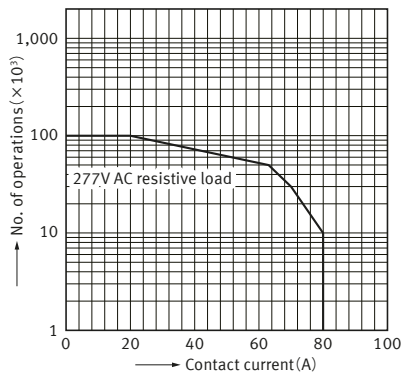

2-2. Switching life curve  
( 4 Form A/4 Form A 1 Form B )

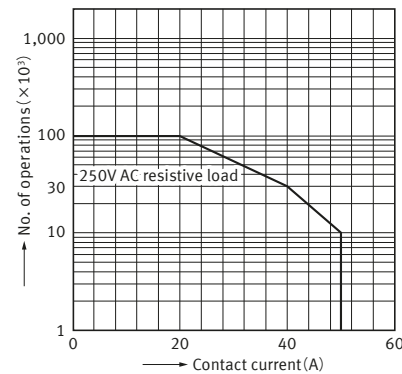

3-1. Coil temperature characteristics  
( 2 Form A/2 Form A 1 Form B )

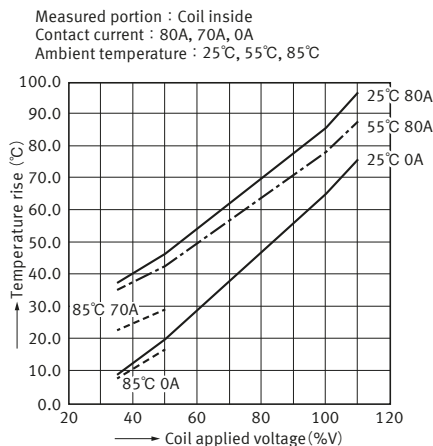

3-2. Coil temperature characteristics  
( 4 Form A/4 Form A 1 Form B )

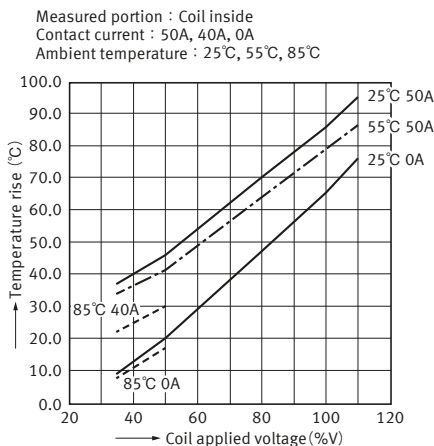

# Power Relays ( Over 2 A ) HE-R RELAYS

## 4-1. Ambient temperature characteristics ( 2 Form A/2 Form A 1 Form B )

Tested sample : AHER2281, 6 pcs.

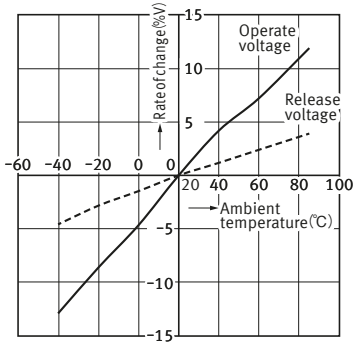

Tested sample : AHER4191, 6 pcs.

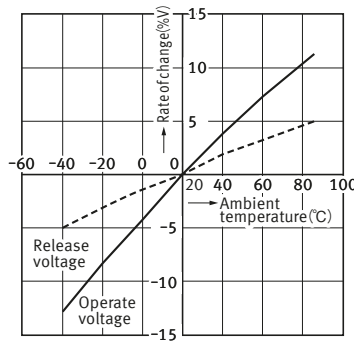

## 5-1. Allowable range of coil holding voltage and temperature ( 2 Form A/2 Form A 1 Form B )

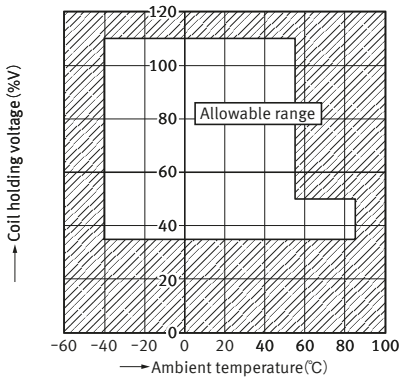

## 5-2. Allowable range of coil holding voltage and temperature ( 4 Form A/4 Form A 1 Form B )

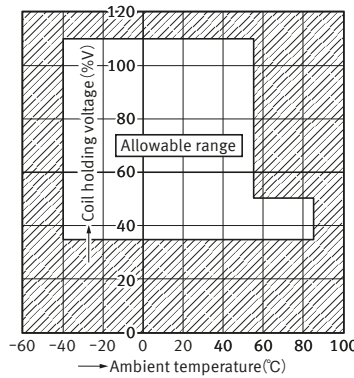

## 6-1. Allowable range of contact current and temperature ( 2 Form A/2 Form A 1 Form B )

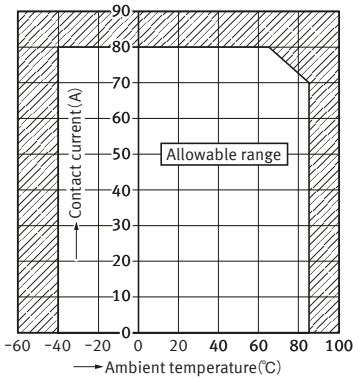

## 6-2. Allowable range of contact current and temperature ( 4 Form A/4 Form A 1 Form B )

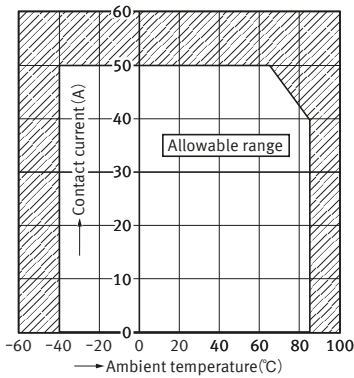

## 7-1. Contact resistance ( 2 Form A/2 Form A 1 Form B )

Tested sample : AHER2281, 20pcs.  
Conditions : 6 V DC, 20 A

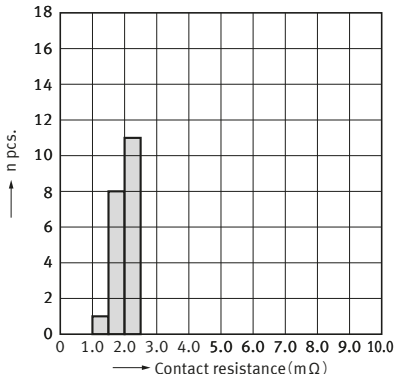

## 7-2. Contact resistance ( 2 Form A/2 Form A 1 Form B )

Tested sample : AHER2281, 20pcs.  
Conditions : 6 V DC, 80 A

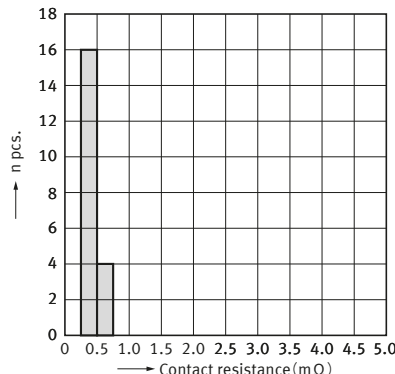

# Power Relays ( Over 2 A ) HE-R RELAYS

## 7-3. Contact resistance ( 4 Form A/4 Form A 1 Form B )

Tested sample : AHER4191, 20pcs.  
Conditions : 6 V DC, 20 A

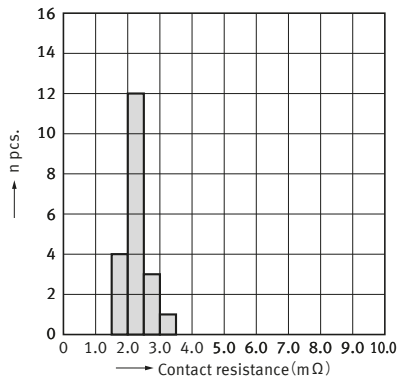

## 7-4. Contact resistance ( 4 Form A/4 Form A 1 Form B )

Tested sample : AHER4191, 20pcs.  
Conditions : 6 V DC, 50 A

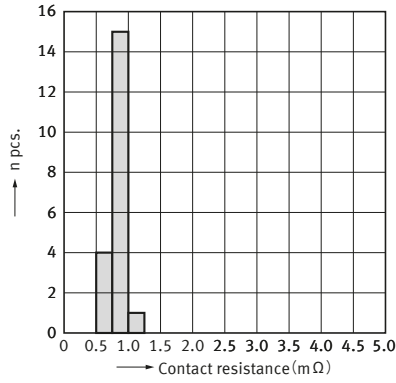

## DIMENSIONS ( Unit: mm )

**CAD** The CAD data of the products with a " CAD " mark can be downloaded from our Website.

### ■ 2 Form A ( 2a )

**CAD**



External dimensions

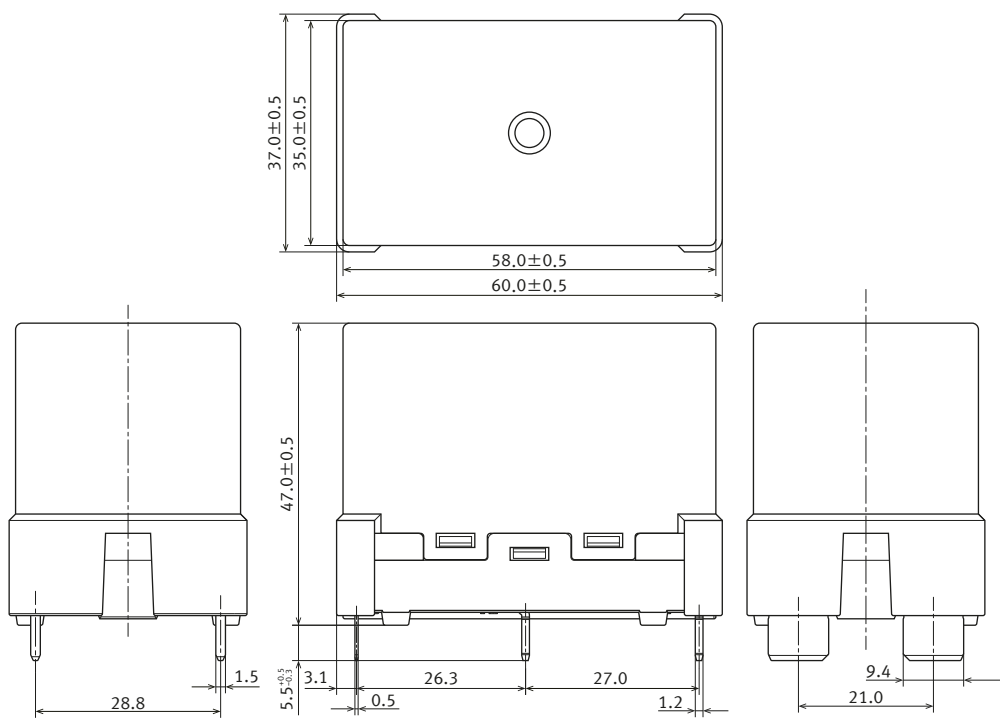

General tolerance ±0.3

Recommended PC board pattern  
( BOTTOM VIEW )

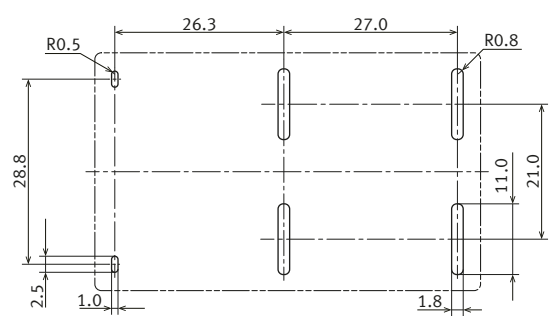

Tolerance ±0.1

Schematic  
( BOTTOM VIEW )

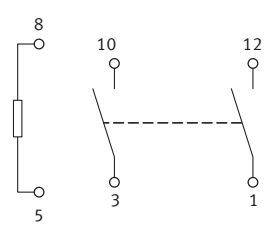

# Power Relays ( Over 2 A ) HE-R RELAYS

## 2 Form A 1 Form B ( 2a1b )

CAD



External dimensions

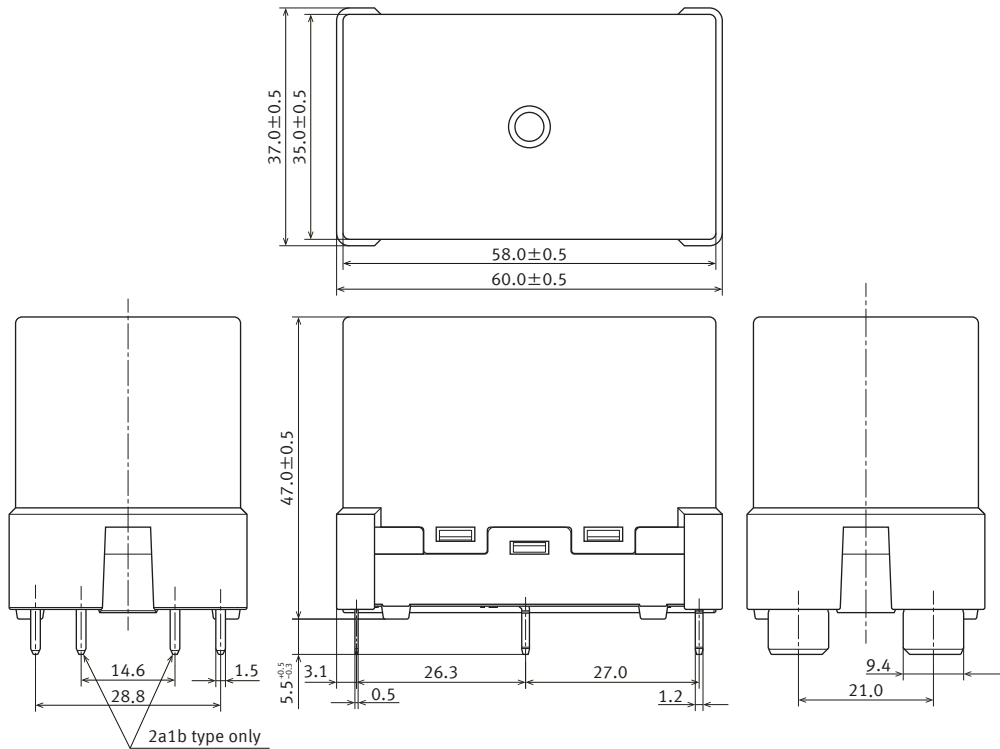

General tolerance  $\pm 0.3$

Recommended PC board pattern ( BOTTOM VIEW )

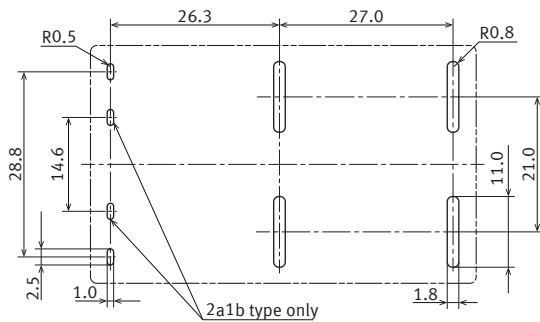

Tolerance  $\pm 0.1$

Schematic ( BOTTOM VIEW )

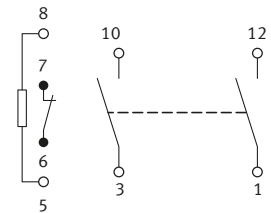

# Power Relays ( Over 2 A ) HE-R RELAYS

■ 4 Form A ( 4a )

CAD



External dimensions

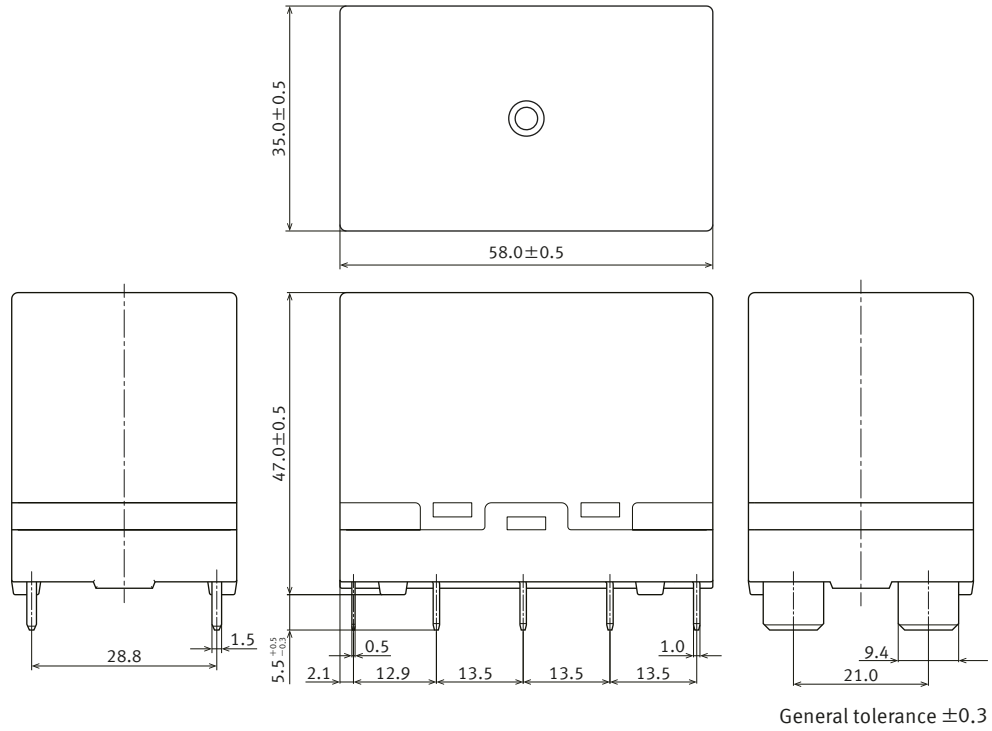

Recommended PC board pattern  
( BOTTOM VIEW )

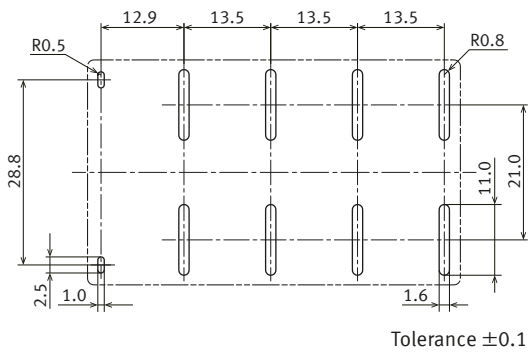

Schematic  
( BOTTOM VIEW )

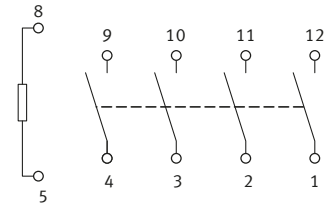

# Power Relays ( Over 2 A ) HE-R RELAYS

## ■ 4 Form A 1 Form B ( 4a1b )

CAD



External dimensions

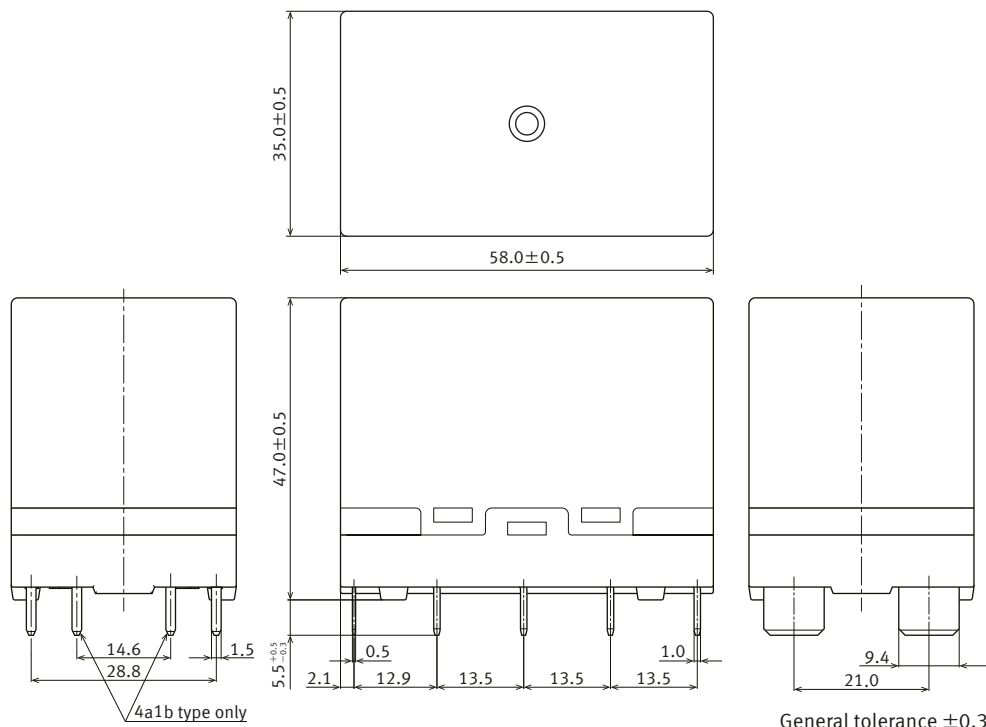

Recommended PC board pattern ( BOTTOM VIEW )

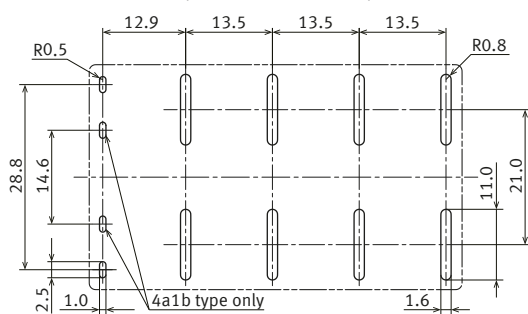

Tolerance  $\pm 0.1$

Schematic ( BOTTOM VIEW )

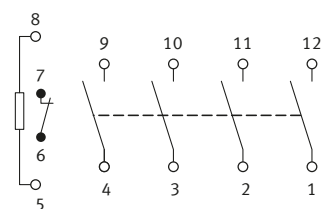

# Power Relays ( Over 2 A ) HE-R RELAYS

## SAFETY STANDARDS

Each standard may be updated at any time, so please check our Website for the latest information.

### UL/C-UL ( Approved )

#### ● 2 Form A/2 Form A 1 Form B

Form A contact

File No.	Contact rating	Operations	Ambient temperature
E43149	80 A 277 V AC Resistive	$10 \times 10^3$	85 °C
	70 A 277 V AC Resistive	$30 \times 10^3$	85 °C
	63 A 277 V AC Resistive	$50 \times 10^3$	85 °C

Short circuit capability

File No.	Contact rating
E43149	I = 5000A rms, pf = 0.7-0.8, U = 240 V AC, Class RK5 fuse rated 100 A ( UL508 table.51.3 )

Form B contact ( 2a1b type only )

File No.	Contact rating	Operations	Ambient temperature
E43149	1 A 30 V DC Resistive	$100 \times 10^3$	85 °C
	1 A 277 V AC Resistive	$100 \times 10^3$	85 °C

#### ● 4 Form A/4 Form A 1 Form B

Form A contact

File No.	Contact rating	Operations	Ambient temperature
E43149	50 A 277 V AC Resistive	$10 \times 10^3$	85 °C
	32 A 277 V AC Resistive	$50 \times 10^3$	85 °C

Form B contact ( 4a1b type only )

File No.	Contact rating	Operations	Ambient temperature
E43149	1 A 30 V DC Resistive	$100 \times 10^3$	85 °C
	1 A 277 V AC Resistive	$100 \times 10^3$	85 °C

### UL ( Approved )

#### ● 4 Form A/4 Form A 1 Form B

Form A contact

File No.	Contact rating	Operations	Ambient temperature
E43149	40 A 480 V AC Resistive	$30 \times 10^3$	85 °C

### VDE ( Approved )

#### ● 2 Form A/2 Form A 1 Form B

Form A contact

File No.	Contact rating	Operations	Ambient temperature
40053274	AC-1:63 A ( $\cos\phi = 1$ ) 250 V AC	$50 \times 10^3$	85 °C
	AC-1:70 A ( $\cos\phi = 1$ ) 250 V AC	$30 \times 10^3$	85 °C
	AC-1:80 A ( $\cos\phi = 1$ ) 250 V AC	$10 \times 10^3$	85 °C

Form B contact ( 2a1b type only )

File No.	Contact rating	Operations	Ambient temperature
40053274	DC-13 24 V DC 1 A, L/R = 48 ms	$40 \times 10^3$	85 °C

#### ● 4 Form A/4 Form A 1 Form B

Form A contact

File No.	Contact rating	Operations	Ambient temperature
40053274	AC-1:32 A ( $\cos\phi = 1$ ) 250 V AC	$50 \times 10^3$	85 °C
	AC-1:40 A ( $\cos\phi = 1$ ) 480 V AC	$30 \times 10^3$	85 °C

Form B contact ( 4a1b type only )

File No.	Contact rating	Operations	Ambient temperature
40053274	DC-13 24 V DC 1 A, L/R = 48 ms	$40 \times 10^3$	85 °C

Short circuit capability

File No.	Contact rating
40053274	I <sub>m</sub> = 500 A, U = 250 V AC, I <sub>p</sub> = 2.6 kA/I <sup>2</sup> t = 6.5 kA <sup>2</sup> s ( IEC62955 )

## INSULATION CHARACTERISTICS ( IEC61810-1 )

Item	Characteristics
Clearance/Creepage distance	Min. 8.0/8.0 mm ( Form A contact )
Category of protection	RT II
Tracking resistance	PTI 175
Insulation material group	III a
Over voltage category	III
Rated voltage	250 V
Pollution degree	3
Type of insulation ( Between contact and coil )	Reinforced insulation ( Form A contact )
Type of insulation ( Between open contact )	Full disconnection ( Form A contact )

# Power Relays ( Over 2 A ) HE-R RELAYS

## GUIDELINES FOR USAGE

■ For cautions for use, please read " GUIDELINES FOR RELAY USAGE ".  
[https://industrial.panasonic.com/ac/e/control/relay/cautions\\_use/index.jsp](https://industrial.panasonic.com/ac/e/control/relay/cautions_use/index.jsp)

### ■ Guidelines for HE-R relays usage

- When coil holding voltage controlled by PWM, check coil holding voltage and operation of relay under the actual condition.
- If this relay is used as a DC high voltage switch, the final failure mode may be uninterruptible.  
 In the event that the power cannot be cut off, in the worst case, the fire may spread to the surrounding area, so the power can be turned off within one second. For safety reasons, consider a fail-safe circuit for your equipment.
- To detect the main contacts welding by Form b contacts, please design the appropriate detection time considering with the release and bounce time. ( 2a1b, 4a1b type )

### ● Conditions for usage, transport and storage

- 1) Ambient temperature
  - 40 to +55 °C  
 ( When applied coil hold voltage is 35 % V to 110 % V of rated coil voltage. )
  - 40 to +85 °C  
 ( When applied coil hold voltage is 35 to 50 % of rated coil voltage or storage. )  
 ( Please reduce the Max. carrying current 0.5 A/°C at +65 °C to +85 °C )
- 2) Humidity
  - 5 to 85 % RH ( Avoid icing and condensation )  
 Note) In addition the humidity range depends on temperature.
- 3) Air pressure
  - 86 to 106 kPa

[ Allowable range of temperature and humidity for usage, transport and storage ]  
 [ 2 Form A/2 Form A 1 Form B ]

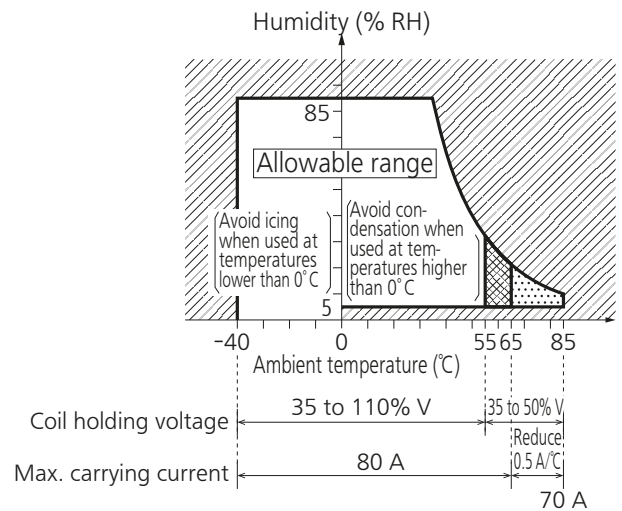

[ 4 Form A/4 Form A 1 Form B ]

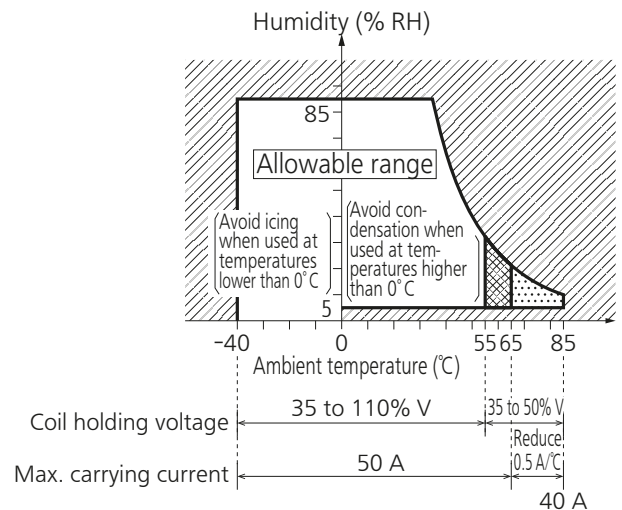

- For cautions for use, please read " GUIDELINES FOR RELAY USAGE ".  
[https://industrial.panasonic.com/ac/e/control/relay/cautions\\_use/index.jsp](https://industrial.panasonic.com/ac/e/control/relay/cautions_use/index.jsp)

## Precautions for Coil Input

### ■ Long term current carrying

A circuit that will be carrying a current continuously for long periods without relay switching operation. ( circuits for emergency lamps, alarm devices and error inspection that, for example, revert only during malfunction and output warnings with form B contacts ) Continuous, long-term current to the coil will facilitate deterioration of coil insulation and characteristics due to heating of the coil itself. For circuits such as these, please use a magnetic-hold type latching relay. If you need to use a single stable relay, use a sealed type relay that is not easily affected by ambient conditions and make a failsafe circuit design that considers the possibility of contact failure or disconnection.

### ■ DC Coil operating power

Steady state DC current should be applied to the coil. The wave form should be rectangular. If it includes ripple, the ripple factor should be less than 5 %. However, please check with the actual circuit since the electrical characteristics may vary. The rated coil voltage should be applied to the coil and the set/reset pulse time of latching type relay differs for each relays, please refer to the relay's individual specifications.

### ■ Coil connection

When connecting coils of polarized relays, please check coil polarity ( + , - ) at the internal connection diagram ( Schematic ). If any wrong connection is made, it may cause unexpected malfunction, like abnormal heat, fire and so on, and circuit do not work. Avoid impressing voltages to the set coil and reset coil at the same time.

### ■ Maximum allowable voltage and temperature rise

Proper usage requires that the rated coil voltage be impressed on the coil. Note, however, that if a voltage greater than or equal to the maximum continuous voltage is impressed on the coil, the coil may burn or its layers short due to the temperature rise. Furthermore, do not exceed the usable ambient temperature range listed in the catalog.

### ● Operate voltage change due to coil temperature rise

In DC relays, after continuous passage of current in the coil, if the current is turned OFF, then immediately turned ON again, due to the temperature rise in the coil, the operate voltage will become somewhat higher. Also, it will be the same as using it in a higher temperature atmosphere. The resistance/temperature relationship for copper wire is about 0.4 % for 1 °C, and with this ratio the coil resistance increases. That is, in order to operate of the relay, it is necessary that the voltage be higher than the operate voltage and the operate voltage rises in accordance with the increase in the resistance value. However, for some polarized relays, this rate of change is considerably smaller.

## Ambient Environment

### Usage, Transport, and Storage Conditions

During usage, storage, or transportation, avoid locations subjected to direct sunlight and maintain normal temperature, humidity and pressure conditions.

#### Temperature/Humidity/Pressure

When transporting or storing relays while they are tube packaged, there are cases the temperature may differ from the allowable range. In this case be sure to check the individual specifications.

Also allowable humidity level is influenced by temperature, please check charts shown below and use relays within mentioned conditions. ( Allowable temperature values differ for each relays, please refer to the relay's individual specifications. )

##### 1) Temperature:

The tolerance temperature range differs for each relays, please refer to the relay's individual specifications

##### 2) Humidity: 5 to 85 % RH

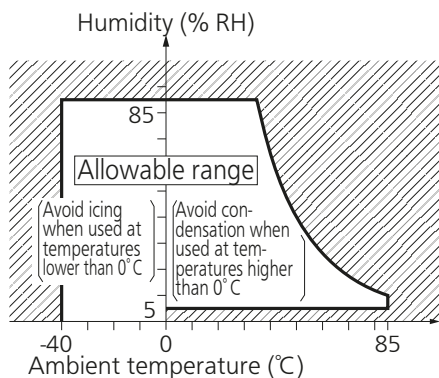

##### 3) Pressure: 86 to 106 kPa

#### Dew condensation

Condensation occurs when the ambient temperature drops suddenly from a high temperature and humidity, or the relay is suddenly transferred from a low ambient temperature to a high temperature and humidity.

Condensation causes the failures like insulation deterioration, wire disconnection and rust etc.

Panasonic Industry Co., Ltd. does not guarantee the failures caused by condensation.

The heat conduction by the equipment may accelerate the cooling of device itself, and the condensation may occur.

Please conduct product evaluations in the worst condition of the actual usage. ( Special attention should be paid when high temperature heating parts are close to the device. Also please consider the condensation may occur inside of the device. )

#### Icing

Condensation or other moisture may freeze on relays when the temperature become lower than 0 °C. This icing causes the sticking of movable portion, the operation delay and the contact conduction failure etc. Panasonic Industry Co., Ltd. does not guarantee the failures caused by the icing.

The heat conduction by the equipment may accelerate the cooling of relay itself and the icing may occur. Please conduct product evaluations in the worst condition of the actual usage.

#### Low temperature and low humidity

The plastic becomes brittle if the relay is exposed to a low temperature, low humidity environment for long periods of time.

#### High temperature and high humidity

Storage for extended periods of time ( including transportation periods ) at high temperature or high humidity levels or in atmospheres with organic gases or sulfide gases may cause a sulfide film or oxide film to form on the surfaces of the contacts and/or it may interfere with the functions. Check out the atmosphere in which the units are to be stored and transported.

#### Package

In terms of the packing format used, make every effort to keep the effects of moisture, organic gases and sulfide gases to the absolute minimum.

#### Silicon

When a source of silicone substances ( silicone rubber, silicone oil, silicone coating materials and silicone filling materials etc. ) is used around the relay, the silicone gas ( low molecular siloxane etc. ) may be produced.

This silicone gas may penetrate into the inside of the relay. When the relay is kept and used in this condition, silicone compound may adhere to the relay contacts which may cause the contact failure. Do not use any sources of silicone gas around the relay ( Including plastic sealed types ).

#### NOx Generation

When relay is used in an atmosphere high in humidity to switch a load which easily produces an arc, the NOx created by the arc and the water absorbed from outside the relay combine to produce nitric acid.

This corrodes the internal metal parts and adversely affects operation.

Avoid use at an ambient humidity of 85 % RH or higher ( at 20 °C ). If use at high humidity is unavoidable, please contact our sales representative.

## Others

### ■ Cleaning

- Although the environmentally sealed type relay ( plastic sealed type, etc. ) can be cleaned, avoid immersing the relay into cold liquid ( such as cleaning solvent ) immediately after soldering. Doing so may deteriorate the sealing performance.
- Cleaning with the boiling method is recommended ( The temperature of cleaning liquid should be 40 °C or lower ). Avoid ultrasonic cleaning on relays. Use of ultrasonic cleaning may cause breaks in the coil or slight sticking of the contacts due to ultrasonic energy.

Please refer to "**the latest product specifications**" when designing your product.

- Requests to customers:

<https://industrial.panasonic.com/ac/e/salespolicies/>