

7-2378159-2 ✓ ACTIVE

[Power Versa-Lock](#) | [Power Versa-Lock 5.0](#)

TE Internal #: 7-2378159-2

2 Position, Plug, Housing, Crimp, Wire-to-Wire, UL 94V-0, 5 mm [.197 in] Centerline, 1 Row, 600 VAC, Sealable, Wire & Cable, Power Versa-Lock 5.0

[View on TE.com >](#)



Connectors > Rectangular Connectors > Standard Rectangular Connectors

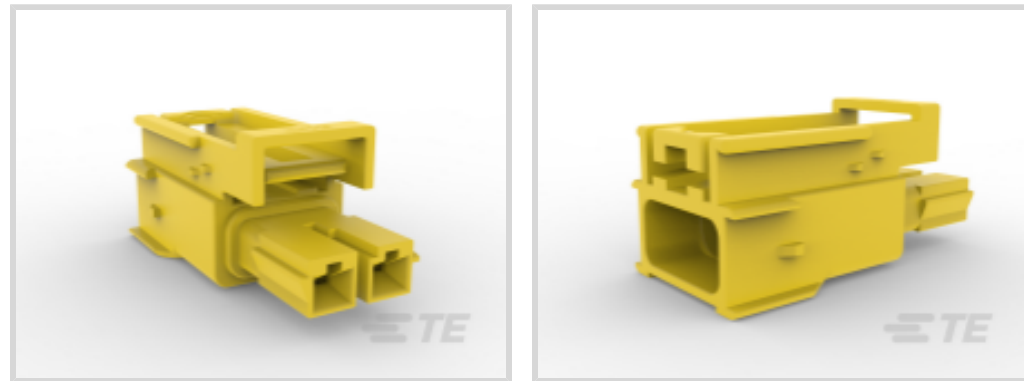

Connector Product Type: **Housing**

Connector & Housing Type: **Plug**

Termination Method to Wire & Cable: **Crimp**

Connector System: **Wire-to-Wire**

Contact Retention Within Housing: **Without**

Features

Product Type Features

Connector Seal & Plug Type	Interfacial Seal
Connector Product Type	Housing
Connector & Housing Type	Plug
Connector System	Wire-to-Wire
Sealable	Yes
Connector & Contact Terminates To	Wire & Cable

Configuration Features

Number of Columns	2
Number of Positions	2
Number of Rows	1
Number of Power Positions	2

Electrical Characteristics

Operating Voltage	600 VDC
-------------------	---------

Body Features

Connector & Keying Code	G
Primary Product Color	Yellow
Cable Exit Angle	180°



Contact Features

Contact Layout	Inline
Contact Retention Within Housing	Without
Contact Type	Receptacle

Termination Features

Termination Method to Wire & Cable	Crimp
------------------------------------	-------

Housing Features

Centerline (Pitch)	5 mm [.197 in]
Housing Material	PBT GF

Usage Conditions

Operating Temperature Range	-30 – 140 °C [-22 – 284 °F]
-----------------------------	-----------------------------

Operation/Application

Circuit Application	Power
---------------------	-------

Identification Marking

Circuit Identification Feature	With
--------------------------------	------

Industry Standards

Compatible With Agency/Standards Products	UL
Compatible With Approved Standards Products	UL E28476
UL Flammability Rating	UL 94V-0
Glow Wire Rating	Standard Part - Not Glow Wire

Packaging Features

Packaging Method	Carton
------------------	--------

Product Compliance

[For compliance documentation, visit the product page on TE.com>](#)

EU RoHS Directive 2011/65/EU	Compliant
EU ELV Directive 2000/53/EC	Compliant
China RoHS 2 Directive MIIT Order No 32, 2016	No Restricted Materials Above Threshold
EU REACH Regulation (EC) No. 1907/2006	Current ECHA Candidate List: JAN 2025 (247) Candidate List Declared Against: JAN 2025 (247) Does not contain REACH SVHC



Halogen Content	Not Low Halogen - contains Br or Cl > 900 ppm.
-----------------	--

Solder Process Capability	Not reviewed for solder process capability
---------------------------	--

Product Compliance Disclaimer

This information is provided based on reasonable inquiry of our suppliers and represents our current actual knowledge based on the information they provided. This information is subject to change. The part numbers that TE has identified as EU RoHS compliant have a maximum concentration of 0.1% by weight in homogenous materials for lead, hexavalent chromium, mercury, PBB, PBDE, DBP, BBP, DEHP, DIBP, and 0.01% for cadmium, or qualify for an exemption to these limits as defined in the Annexes of Directive 2011/65/EU (RoHS2). Finished electrical and electronic equipment products will be CE marked as required by Directive 2011/65/EU. Components may not be CE marked. Additionally, the part numbers that TE has identified as EU ELV compliant have a maximum concentration of 0.1% by weight in homogenous materials for lead, hexavalent chromium, and mercury, and 0.01% for cadmium, or qualify for an exemption to these limits as defined in the Annexes of Directive 2000/53/EC (ELV). Regarding the REACH Regulation, the information TE provides on SVHC in articles for this part number is based on the latest European Chemicals Agency (ECHA) 'Guidance on requirements for substances in articles' posted at this URL: <https://echa.europa.eu/guidance-documents/guidance-on-reach>

Compatible Parts



TE Part # 2334614-2
Power Versa-Lock BACK COVER 2P



TE Part # 2325349-2
Power Versa-Lock REAR SEAL, 1X2, LargeID



TE Part # 2329912-1
Power Versa-Lock RECPT, 18-20, 2X22 AWG



TE Part # 2329914-1
Power Versa-Lock SEAL RECPT, 18-20 AWG



TE Part # 2329915-1
Power Versa-Lock RECPT, 22-26 AWG



TE Part # 2329916-1
Power Versa-Lock SEAL RECPT, 14-16 AWG



TE Part # 7-2378158-2
Power Versa-Lock CAP, 1X2 KEY G



TE Part # 3-2325349-2
PWR VERSA-LOCK REAR SEAL, 1X2, 1.5-2.4



TE Part # 2325347-2
Power Versa-Lock INTERFACE SEAL, 1X2

Also in the Series | Power Versa-Lock 5.0

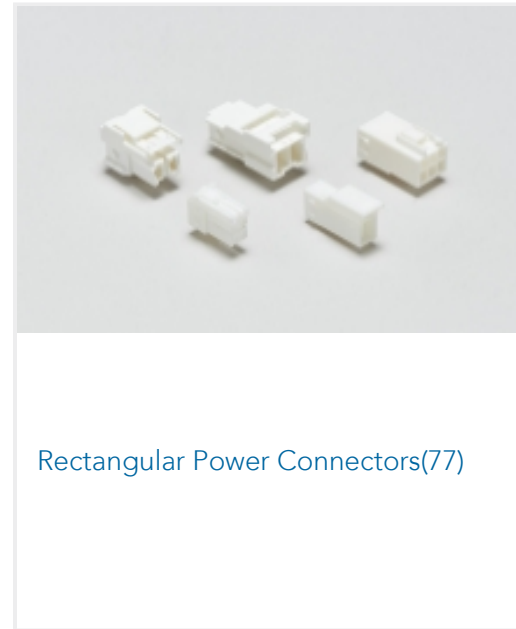
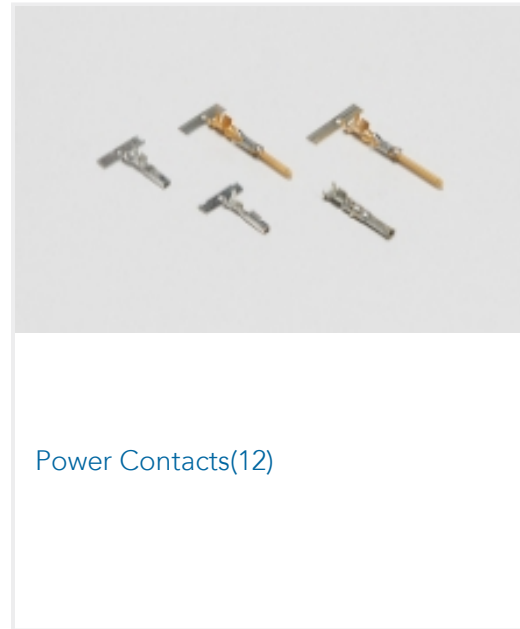
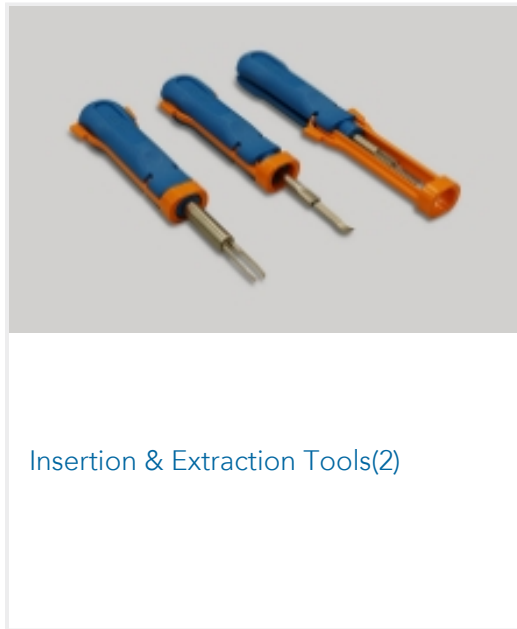
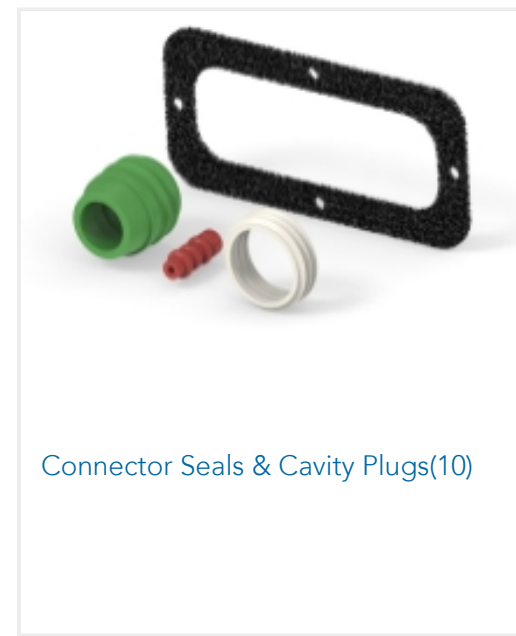
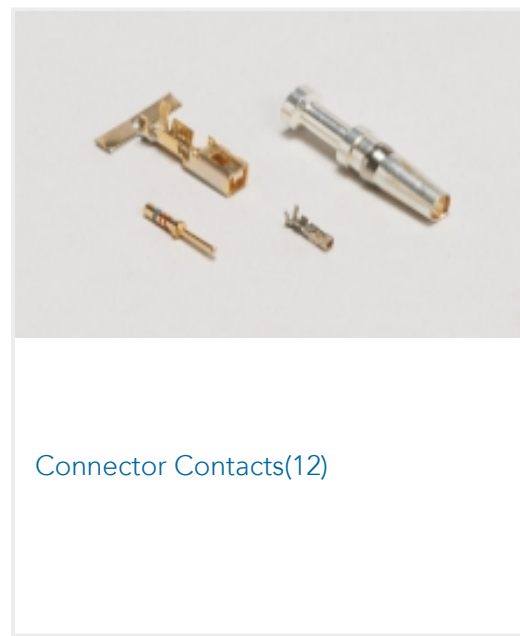
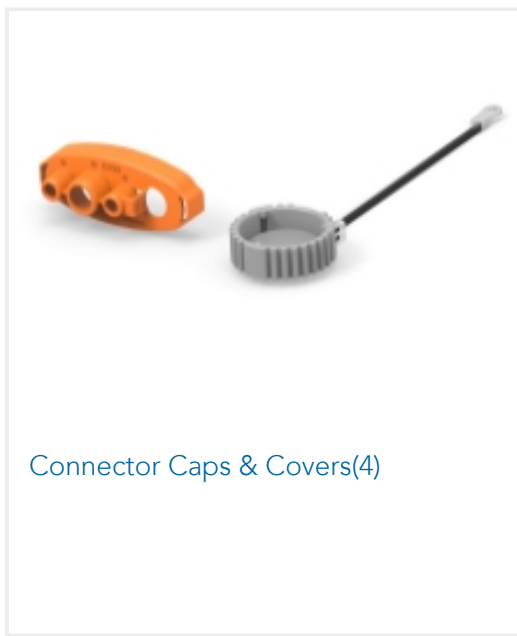

Customers Also Bought

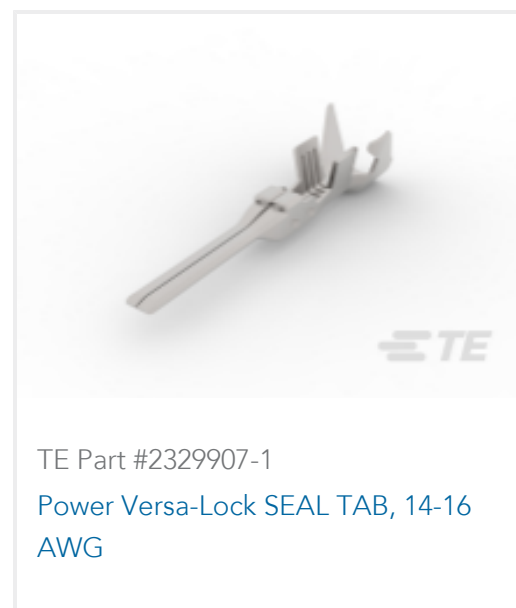
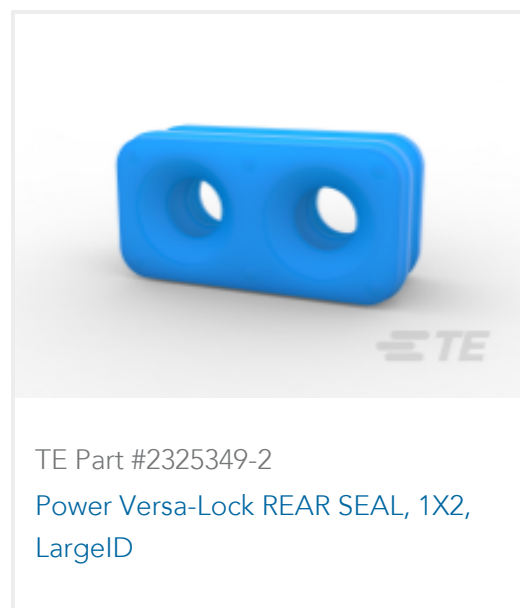
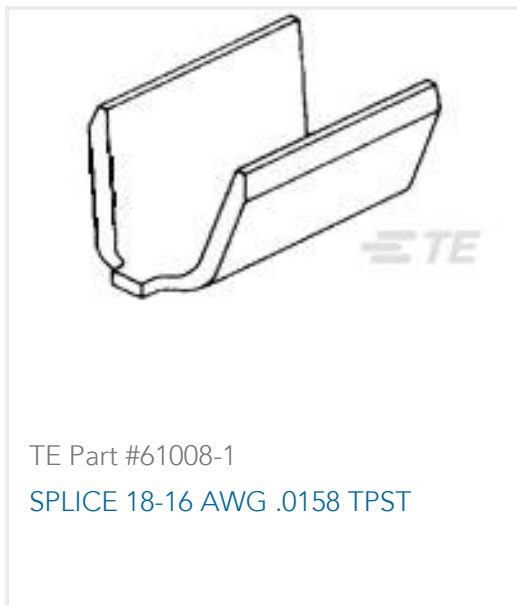

Documents



Product Drawings

[Power Versa-Lock PLUG, 1X2 KEY G](#)

English

[Power Versa-Lock PLUG, 1X2 KEY G](#)

English

CAD Files

[3D PDF](#)

3D

Customer View Model

[ENG_CVM_CVM_7-2378159-2_A.2d_dxf.zip](#)

English

Customer View Model

[ENG_CVM_CVM_7-2378159-2_A.3d_igs.zip](#)

English

Customer View Model

[ENG_CVM_CVM_7-2378159-2_A.3d_stp.zip](#)

English

By downloading the CAD file I accept and agree to the [Terms and Conditions](#) of use.

Datasheets & Catalog Pages

[power-versa-lock-connectors-0421](#)

English

Product Specifications

[Engineering Report](#)

English

Instruction Sheets

[Instruction Sheet \(U.S.\)](#)

English

Agency Approvals

[UL Report](#)

English