



zQSFP+/QSFP28

TE Internal #: 2333393-3

QSFP28 Cable Assembly, 16 Positions, 1 m [3.28 ft], 25 Gb/s, Black Cable, Shielded, 30 AWG, .051 mm² Wire, QSFP28 Plug End A, QSFP28 Plug End B, CL2

[View on TE.com >](#)

Cable Assemblies > Copper Cable Assemblies > Pluggable I/O Cable Assemblies > QSFP28 to QSFP28 Cable Assembly: 30 AWG

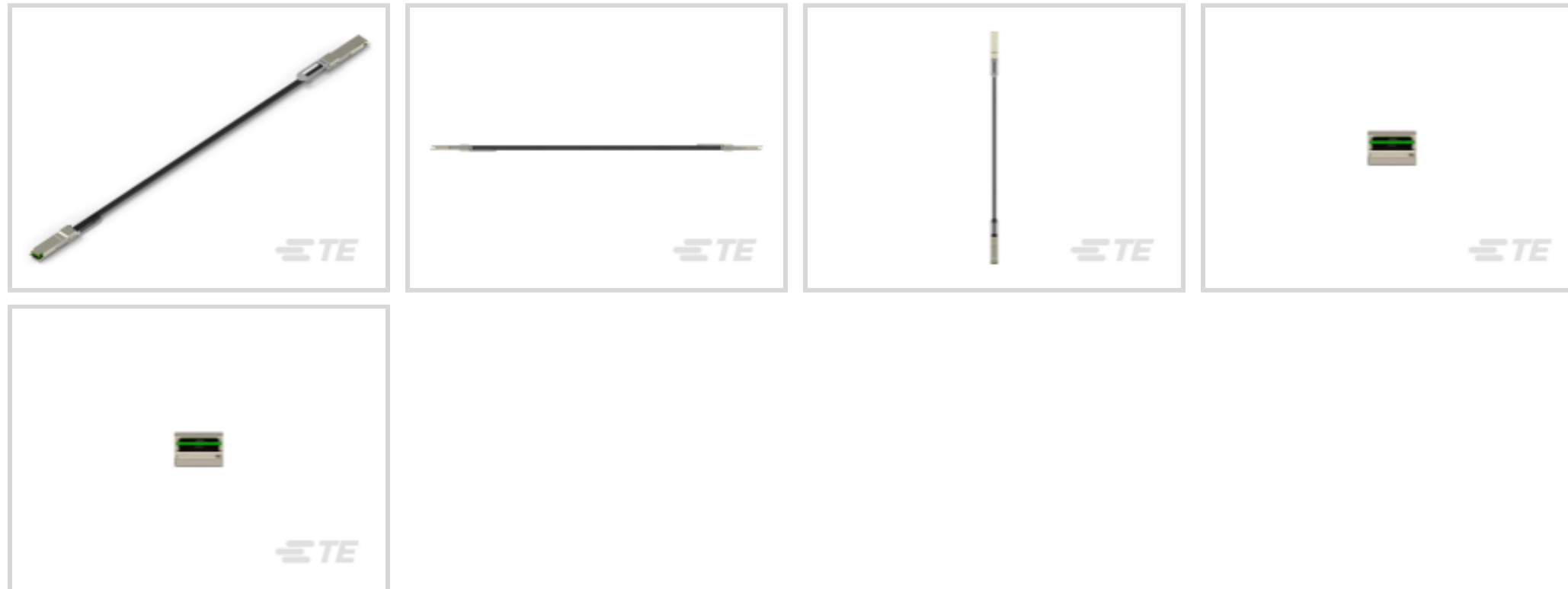

Cable Assembly Type: **QSFP28**

Cable Assembly (End A): **QSFP28 Plug**

Cable Assembly (End B): **QSFP28 Plug**

Wire Size: **.051 mm²**

[All QSFP28 to QSFP28 Cable Assembly: 30 AWG \(6\)](#)

Features

Product Type Features

Cable Assembly Category	High Speed, Industry Standard
Cable Assembly Type	QSFP28
Cable Assembly (End A)	QSFP28 Plug
Cable Assembly (End B)	QSFP28 Plug
Cable Style	Madison TurboTwin - Round Jacketed

Configuration Features

Number of Positions	16
Number of Pairs	8
Number of Signal Positions	16

Electrical Characteristics

Impedance	100 Ω
-----------	-------

Signal Characteristics

Data Rate	25 Gb/s
-----------	---------



Body Features

Cable Color	Black
Cable Flammability Rating	CL2
Equalized	No

Dimensions

Wire Size	.051 mm ²
Outside Cable Diameter	6.2 mm[.244 in]

Operation/Application

Shielded	Yes
Halogen Free	No

Other

Cable Assembly Configuration	Double Ended
Cable Assembly Length	1 m[3.28 ft]

Product Compliance

[For compliance documentation, visit the product page on TE.com>](#)

EU RoHS Directive 2011/65/EU	Compliant with Exemptions
EU ELV Directive 2000/53/EC	Compliant
China RoHS 2 Directive MIIT Order No 32, 2016	Restricted Materials Above Threshold
EU REACH Regulation (EC) No. 1907/2006	<p>Current ECHA Candidate List: JAN 2025 (247)</p> <p>Candidate List Declared Against: JAN 2025 (247)</p> <p>SVHC > Threshold:</p> <p>2-methyl-1-(4-methylthiophenyl)-2-morpholinopropan-1-one (4.5% in 34983907383)</p> <p>TBPH (12% in 26862205067)</p> <p>Pb (.11% in 34983907395)</p> <p>Article Safe Usage Statements: Do not eat, drink or smoke when using this product. Wash thoroughly after handling. Do not handle until all safety precautions have been read and understood. Recycle if possible and dispose of the article by following all applicable governmental regulations relevant to your geographic location.</p>
Halogen Content	Not Low Halogen - contains Br or Cl > 900 ppm.
Solder Process Capability	Not reviewed for solder process capability

Product Compliance Disclaimer

This information is provided based on reasonable inquiry of our suppliers and represents our current actual knowledge based on the information they provided. This information is subject to change. The part numbers that TE has identified as



EU RoHS compliant have a maximum concentration of 0.1% by weight in homogenous materials for lead, hexavalent chromium, mercury, PBB, PBDE, DBP, BBP, DEHP, DIBP, and 0.01% for cadmium, or qualify for an exemption to these limits as defined in the Annexes of Directive 2011/65/EU (RoHS2). Finished electrical and electronic equipment products will be CE marked as required by Directive 2011/65/EU. Components may not be CE marked. Additionally, the part numbers that TE has identified as EU ELV compliant have a maximum concentration of 0.1% by weight in homogenous materials for lead, hexavalent chromium, and mercury, and 0.01% for cadmium, or qualify for an exemption to these limits as defined in the Annexes of Directive 2000/53/EC (ELV). Regarding the REACH Regulation, the information TE provides on SVHC in articles for this part number is based on the latest European Chemicals Agency (ECHA) 'Guidance on requirements for substances in articles' posted at this URL: <https://echa.europa.eu/guidance-documents/guidance-on-reach>

Compatible Parts

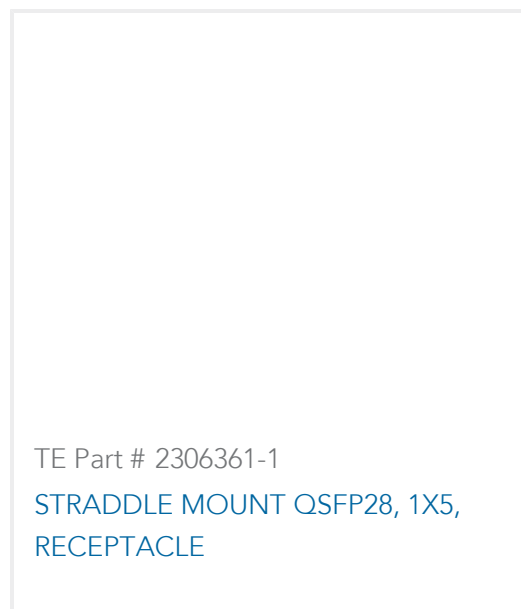

TE Part # 2306361-1
STRADDLE MOUNT QSFP28, 1X5, RECEPTACLE



TE Part # 2170826-6
CAGE ASSEMBLY, 1X2, QSFP28, SPRING, HS, LP



TE Part # 2170807-4
CAGE ASSY, 1X2, QSFP28, SPRING, QUAD LP

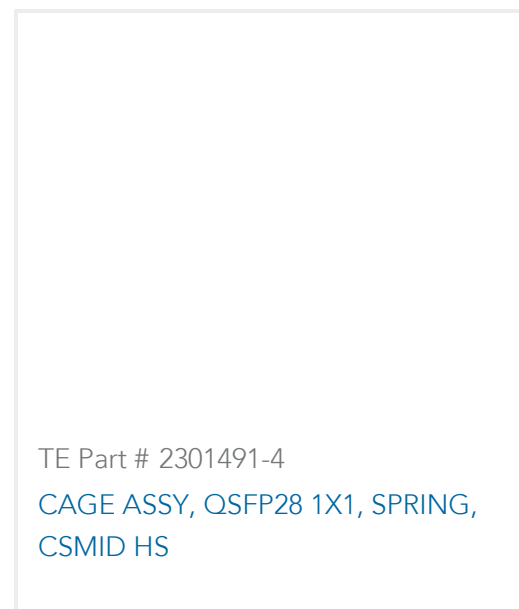

TE Part # 2301491-4
CAGE ASSY, QSFP28 1X1, SPRING, CSMID HS



TE Part # 5-2289708-4
QSFP28, 1X3, CAGE ASSY, SPRING, HS, SQLP



TE Part # 1-2170704-0
CAGE ASSY, QSFP28 1X1, SPRING, HS

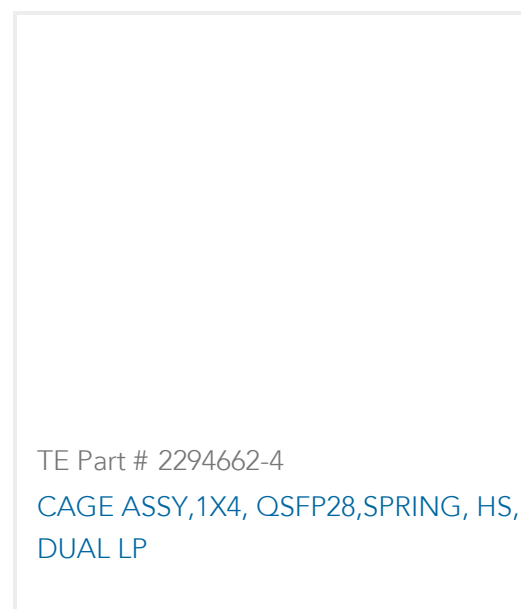

TE Part # 2294662-4
CAGE ASSY, 1X4, QSFP28, SPRING, HS, DUAL LP



TE Part # 2170708-4
CAGE ASSY, 1X6, QSFP28, SPRING, HS, LP



TE Part # 2311786-1
CAGE ASSY, QSFP28 1X1, GASKET, HS, LP



TE Part # 2274086-1
Cage Assy 1x2 Behind Bezel Gasket QSFP28



TE Part # 2312220-1
CAGE ASSEMBLY, QSFP28 1X1, PCI, SPRING



TE Part # 2170708-5
CAGE ASSY, 1X6, QSFP28, SPRING, HS, LP



TE Part # 2173482-3
1xN QSFP28 Bhnd Bzl Dbl LP, 58,49 Long

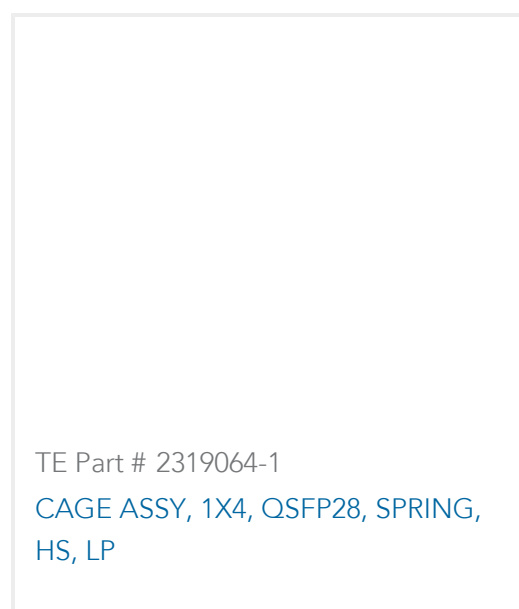

TE Part # 2319064-1
CAGE ASSY, 1X4, QSFP28, SPRING, HS, LP



TE Part # 1-2170790-3
CAGE ASSY, 1X4, QSFP28, SPRING, HS, LP



TE Part # 2170814-2
QSFP28, 1X2, CAGE ASSY, GASKET, HS, LP



TE Part # 2-2170814-1
QSFP28, 1X2, CAGE ASSY, GASKET, HS, LP



TE Part # 2-2170814-4
QSFP28, 1X2, CAGE ASSY, GASKET, HS, LP



TE Part # 2170827-4
CAGE ASSEMBLY, 1X2, QSFP28, GASKET,HS,LP



TE Part # 2170752-4
CAGE ASSEMBLY, QSFP28 1X1, GASKET

Also in the Series | **zQSFP+/QSFP28**



Pluggable I/O Cable Assemblies(78)



Pluggable IO Connectors & Cages(394)



QSFP, QSFP+ & zQSFP+(394)

Customers Also Bought



TE Part #GA10K3435STM010
PRO4-OVERMOLDED PROBE

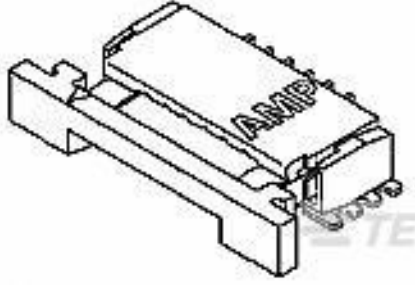

TE Part #2-84952-0
1MM FPC HORZ.BTTM CONT.ASS.20P



TE Part #1571983-4
GDH04S04=DIP SWITCH



TE Part #3-1676480-2
CRG0402 1% 20K



TE Part #1734795-7
MOD JACK,RJ45,8P8C,SHIELD, W /PANEL,30u"



TE Part #1825516-2
MSP103C04



TE Part #1-2176326-4
CRGP 0603 120R 1%



TE Part #1-2127931-2
C/A, SFP+, GENERIC, 1.0M

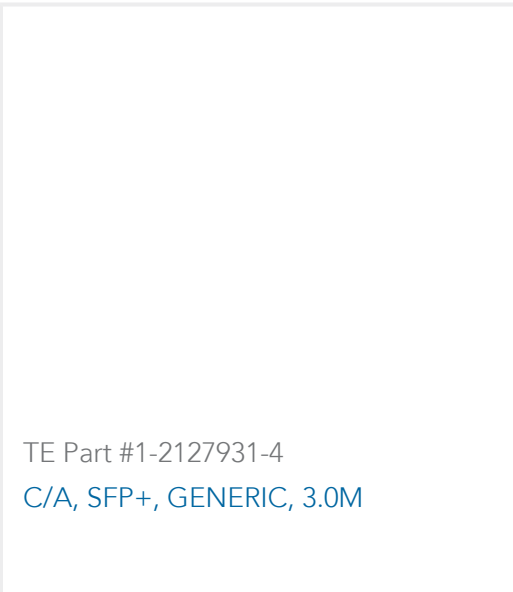

TE Part #1-2127931-4
C/A, SFP+, GENERIC, 3.0M

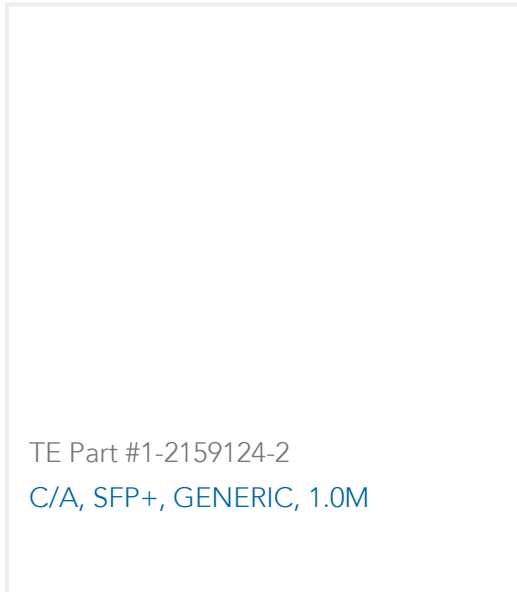

TE Part #1-2159124-2
C/A, SFP+, GENERIC, 1.0M



Documents

Product Drawings

[QSFP 25GIG 30AWG 1 METER](#)

English

CAD Files

[3D PDF](#)

3D

Customer View Model

[ENG_CVM_CVM_2333393-3_A.2d_dxf.zip](#)

English

Customer View Model

[ENG_CVM_CVM_2333393-3_A.3d_igs.zip](#)

English

Customer View Model

[ENG_CVM_CVM_2333393-3_A.3d_stp.zip](#)

English

By downloading the CAD file I accept and agree to the [Terms and Conditions](#) of use.

Product Specifications

[Product Specification](#)

English