

2-2338183-3 ✓ ACTIVE

Economy Power 2.5

TE Internal #: 2-2338183-3

3 Position, Receptacle, Housing, Crimp, Wire-to-Board, 2.5 mm [.098 in] Centerline, 1 Row, Wire & Cable, Power & Signal, Economy Power 2.5

[View on TE.com >](#)



Connectors > Rectangular Connectors > Standard Rectangular Connectors

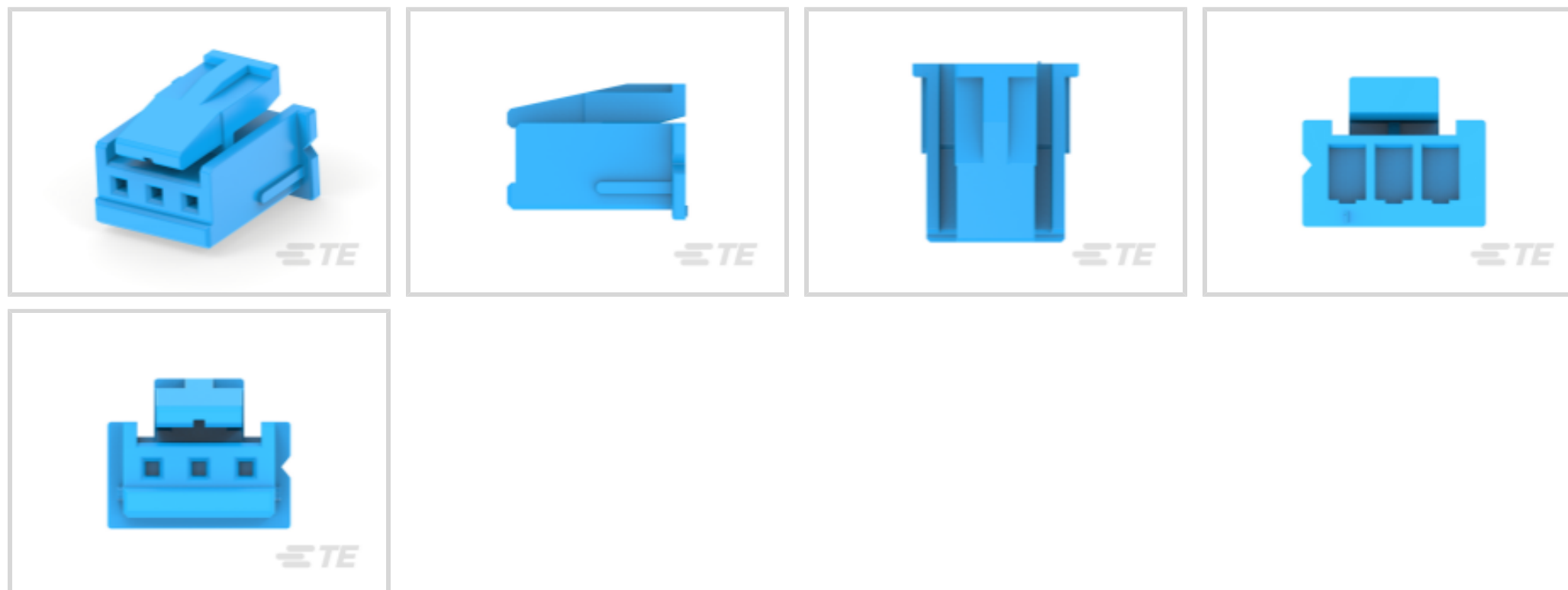

Connector Product Type: **Housing**

Connector & Housing Type: **Receptacle**

Mating Retention Type: **Latch**

Connector System: **Wire-to-Board**

Number of Positions: **3**

Features

Product Type Features

Connector Product Type	Housing
Connector & Housing Type	Receptacle
Connector System	Wire-to-Board
Sealable	No
Connector & Contact Terminates To	Wire & Cable

Configuration Features

Number of Positions	3
Number of Rows	1

Body Features

Primary Product Color	Blue
-----------------------	------

Contact Features

Contact Current Rating (Max)	4.2 A
------------------------------	-------

Termination Features

--	--



Termination Method to Wire & Cable	Crimp
------------------------------------	-------

Mechanical Attachment

Mating Retention Type	Latch
-----------------------	-------

Mating Retention	With
------------------	------

Connector Mounting Type	Cable Mount (Free-Hanging)
-------------------------	----------------------------

Housing Features

Centerline (Pitch)	2.5 mm [.098 in]
--------------------	------------------

Usage Conditions

Operating Temperature Range	-55 – 105 °C [-67 – 221 °F]
-----------------------------	-----------------------------

Operation/Application

Circuit Application	Power & Signal
---------------------	----------------

Product Compliance

[For compliance documentation, visit the product page on TE.com>](#)

EU RoHS Directive 2011/65/EU	Compliant
------------------------------	-----------

EU ELV Directive 2000/53/EC	Compliant
-----------------------------	-----------

China RoHS 2 Directive MIIT Order No 32, 2016	No Restricted Materials Above Threshold
-----------------------------------------------	-----------------------------------------

EU REACH Regulation (EC) No. 1907/2006	Current ECHA Candidate List: JAN 2025 (247) Candidate List Declared Against: JAN 2025 (247) Does not contain REACH SVHC
----------------------------------------	-------------------------------------------------------------------------------------------------------------------------------

Halogen Content	Not Low Halogen - contains Br or Cl > 900 ppm.
-----------------	------------------------------------------------

Solder Process Capability	Not reviewed for solder process capability
---------------------------	--------------------------------------------

Product Compliance Disclaimer

This information is provided based on reasonable inquiry of our suppliers and represents our current actual knowledge based on the information they provided. This information is subject to change. The part numbers that TE has identified as EU RoHS compliant have a maximum concentration of 0.1% by weight in homogenous materials for lead, hexavalent chromium, mercury, PBB, PBDE, DBP, BBP, DEHP, DIBP, and 0.01% for cadmium, or qualify for an exemption to these limits as defined in the Annexes of Directive 2011/65/EU (RoHS2). Finished electrical and electronic equipment products will be CE marked as required by Directive 2011/65/EU. Components may not be CE marked. Additionally, the part numbers that TE has identified as EU ELV compliant have a maximum concentration of 0.1% by weight in homogenous materials for lead, hexavalent chromium, and mercury, and 0.01% for cadmium, or qualify for an exemption to these limits as defined in the Annexes of Directive 2000/53/EC (ELV). Regarding the REACH Regulation, the information TE provides on SVHC in articles for this part number is based on the latest European Chemicals Agency (ECHA) 'Guidance on requirements for substances in articles' posted at this URL: <https://echa.europa.eu/guidance-documents/guidance-on-reach>

Compatible Parts

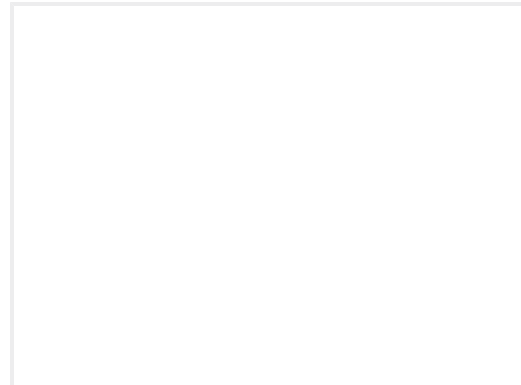

TE Part # 2-2421771-3
EP2.5 HDR ASSY 3P VERT W/O BOSS, BLUE,UL



TE Part # 2-2338245-3
EP2.5 HDR 3P VERT BOSS,BLUE,UL



TE Part # 2-2338244-3
EP2.5 HDR 3P VERT W/O BOSS,BLUE, UL

Also in the Series | Economy Power 2.5



Connector Contacts(6)



Connector Hardware(49)



PCB Headers & Receptacles(533)



Rectangular Connector Housings(305)



Rectangular Power Connectors(835)

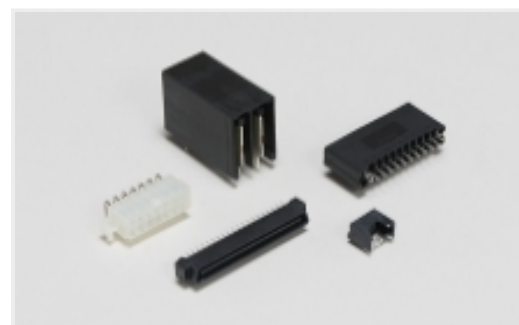

Standard Rectangular Connectors(305)

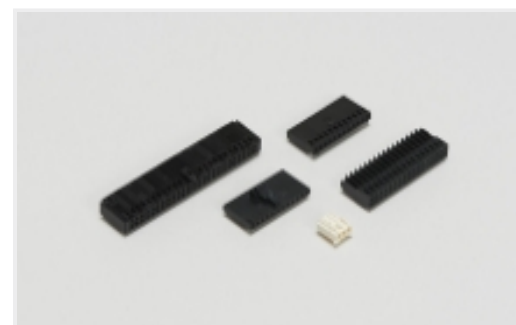

Wire-to-Board Connector Assemblies & Housings(134)

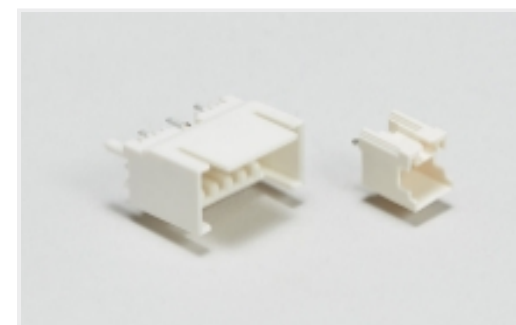

Wire-to-Board Headers & Receptacles (533)

Customers Also Bought



TE Part #ADP-SMAF-SMAF
SMA Jack to SMA Jack

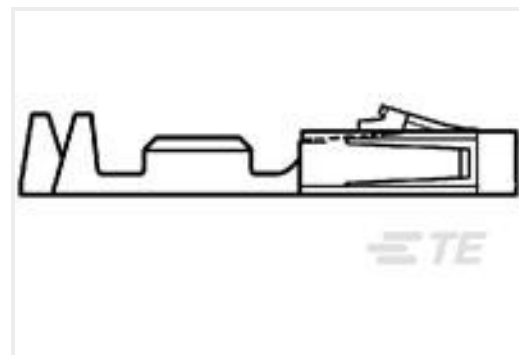

TE Part #1-104480-7
SHORT POINT CONT PLTD SN



TE Part #350551-6
UMNL SOK 20-14 AU/PHBZ L/P



TE Part #1-770902-0
MINI UMNL SOK 26-22 AWG AU



Documents

Product Drawings

[EP 2.5 HOUSING 3P, BLUE, UL version](#)

English

CAD Files

[3D PDF](#)

3D

Customer View Model

[ENG_CVM_CVM_2-2338183-3_A.2d_dxf.zip](#)

English

Customer View Model

[ENG_CVM_CVM_2-2338183-3_A.3d_igs.zip](#)

English

Customer View Model

[ENG_CVM_CVM_2-2338183-3_A.3d_stp.zip](#)

English

By downloading the CAD file I accept and agree to the [Terms and Conditions](#) of use.

Product Specifications

[Application Specification](#)

English

Agency Approvals

[VDE Certificate](#)

English