

2-1971775-4 ✓ ACTIVE



### Power Triple Lock

TE Internal #: 2-1971775-4

8 Position, Cap, Housing, Crimp, Wire-to-Wire, UL 94V-0, 6 mm [.236 in] Centerline, 2 Row, 600 VAC, Wire & Cable, Power, Power Triple Lock

[View on TE.com >](#)

Connectors > Rectangular Connectors > Standard Rectangular Connectors > Standard Temperature Caps | POWER TRIPLE LOCK



Connector Product Type: **Housing**

Connector & Housing Type: **Cap**

Termination Method to Wire & Cable: **Crimp**

Connector System: **Wire-to-Wire**

Contact Retention Within Housing: **Without**

[All Standard Temperature Caps | POWER TRIPLE LOCK \(40\)](#)

## Features

### Product Type Features

Connector Product Type	Housing
Connector & Housing Type	Cap
Connector System	Wire-to-Wire
Sealable	No
Connector & Contact Terminates To	Wire & Cable

### Configuration Features

Number of Positions	8
Number of Rows	2
Number of Power Positions	8

### Electrical Characteristics

Operating Voltage	600 VDC
-------------------	---------

### Body Features



Connector & Keying Code	B
Primary Product Color	Purple
Cable Exit Angle	180°

#### Contact Features

Contact Layout	Matrix
Contact Retention Within Housing	Without
Contact Type	Tab

#### Termination Features

Termination Method to Wire & Cable	Crimp
------------------------------------	-------

#### Mechanical Attachment

Panel Mount Feature	With
Panel Mount Feature Type	Latches
Connector Mounting Type	Panel Mount

#### Housing Features

Centerline (Pitch)	6 mm [.236 in]
Housing Material	PBT GF

#### Dimensions

Panel Thickness (Recommended)	1 – 2 mm [.039 – .079 in]
Connector Height	23.05 mm
Row-to-Row Spacing	8.1 mm [.319 in]

#### Usage Conditions

Operating Temperature Range	-55 – 105 °C [-67 – 221 °F]
-----------------------------	-----------------------------

#### Operation/Application

Circuit Application	Power
---------------------	-------

#### Identification Marking

Circuit Identification Feature	With
--------------------------------	------

#### Industry Standards

Compatible With Agency/Standards Products	UL
UL Rating	Recognized
Compatible With Approved Standards Products	UL E28476
UL Flammability Rating	UL 94V-0



Glow Wire Rating	Standard Part - Not Glow Wire
------------------	-------------------------------

**Packaging Features**

Packaging Method	Carton
------------------	--------

**Product Compliance**

[For compliance documentation, visit the product page on TE.com>](#)

EU RoHS Directive 2011/65/EU	Compliant
EU ELV Directive 2000/53/EC	Compliant
China RoHS 2 Directive MIIT Order No 32, 2016	No Restricted Materials Above Threshold
EU REACH Regulation (EC) No. 1907/2006	Current ECHA Candidate List: JAN 2025 (247) Candidate List Declared Against: JAN 2025 (247) Does not contain REACH SVHC
Halogen Content	Not Low Halogen - contains Br or Cl > 900 ppm.
Solder Process Capability	Not reviewed for solder process capability

Product Compliance Disclaimer

This information is provided based on reasonable inquiry of our suppliers and represents our current actual knowledge based on the information they provided. This information is subject to change. The part numbers that TE has identified as EU RoHS compliant have a maximum concentration of 0.1% by weight in homogenous materials for lead, hexavalent chromium, mercury, PBB, PBDE, DBP, BBP, DEHP, DIBP, and 0.01% for cadmium, or qualify for an exemption to these limits as defined in the Annexes of Directive 2011/65/EU (RoHS2). Finished electrical and electronic equipment products will be CE marked as required by Directive 2011/65/EU. Components may not be CE marked. Additionally, the part numbers that TE has identified as EU ELV compliant have a maximum concentration of 0.1% by weight in homogenous materials for lead, hexavalent chromium, and mercury, and 0.01% for cadmium, or qualify for an exemption to these limits as defined in the Annexes of Directive 2000/53/EC (ELV). Regarding the REACH Regulation, the information TE provides on SVHC in articles for this part number is based on the latest European Chemicals Agency (ECHA) 'Guidance on requirements for substances in articles' posted at this URL: <https://echa.europa.eu/guidance-documents/guidance-on-reach>

**Compatible Parts**





## Also in the Series | Power Triple Lock

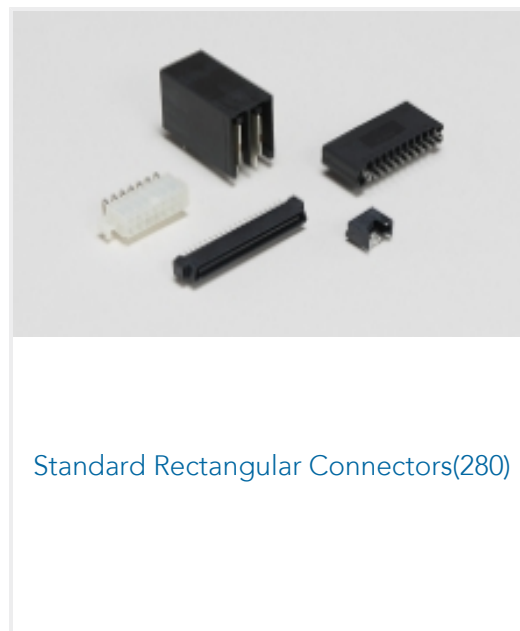
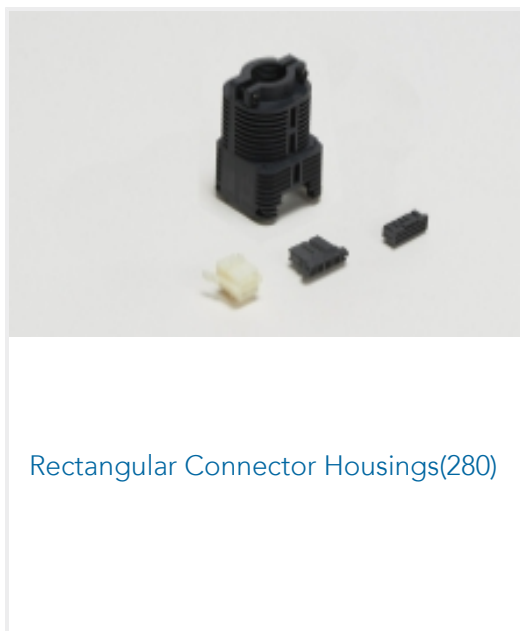
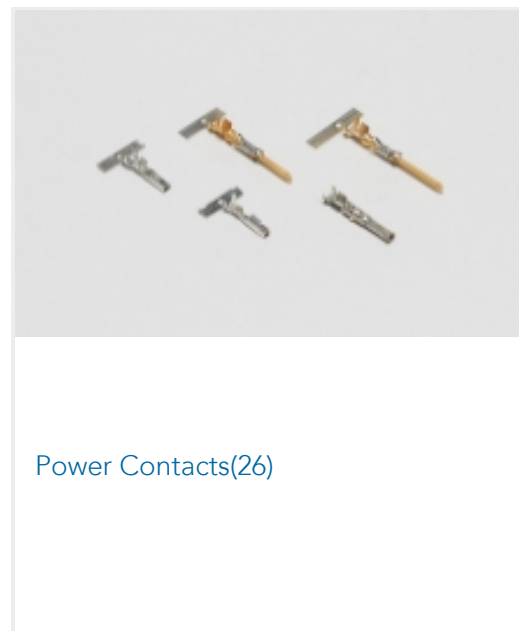
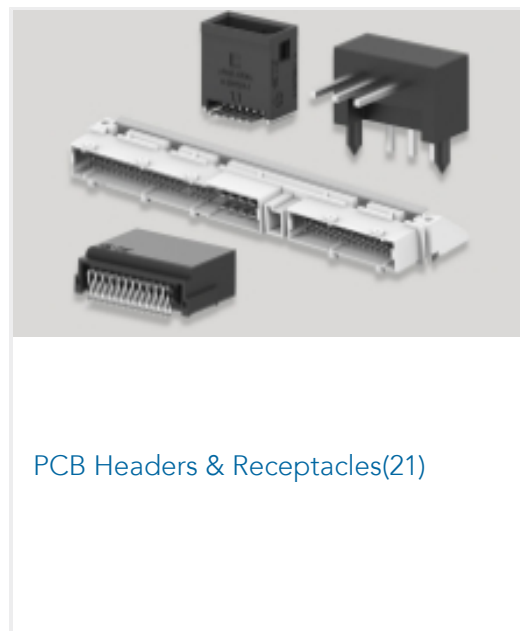
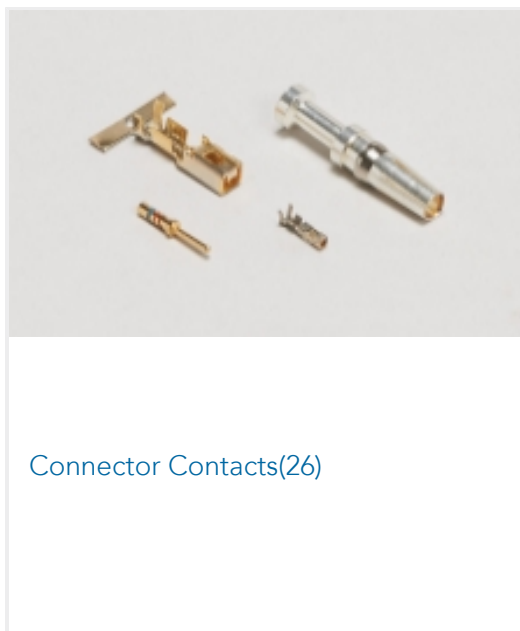

## Customers Also Bought

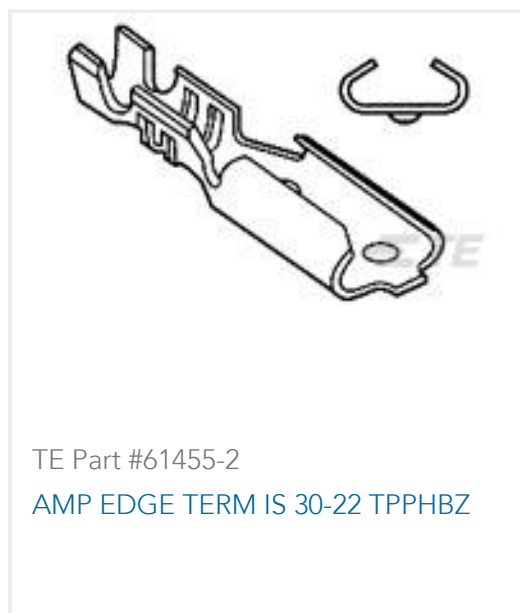

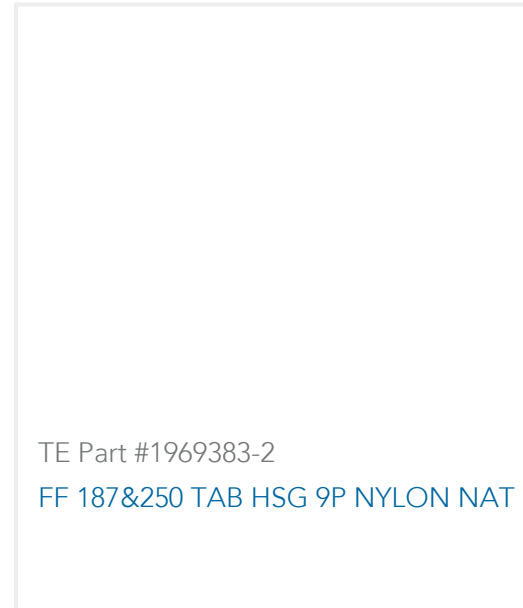

## Documents

### Product Drawings

[PTL 2X4 CAP PANEL MT STD TEMP KEY B PUR](#)

English

### CAD Files

[3D PDF](#)

3D

Customer View Model

[ENG\\_CVM\\_CVM\\_2-1971775-4\\_F.2d\\_dxf.zip](#)

English

Customer View Model

[ENG\\_CVM\\_CVM\\_2-1971775-4\\_F.3d\\_igs.zip](#)

English

Customer View Model

[ENG\\_CVM\\_CVM\\_2-1971775-4\\_F.3d\\_stp.zip](#)

English

By downloading the CAD file I accept and agree to the [Terms and Conditions](#) of use.

### Product Specifications

[Application Specification](#)

English