

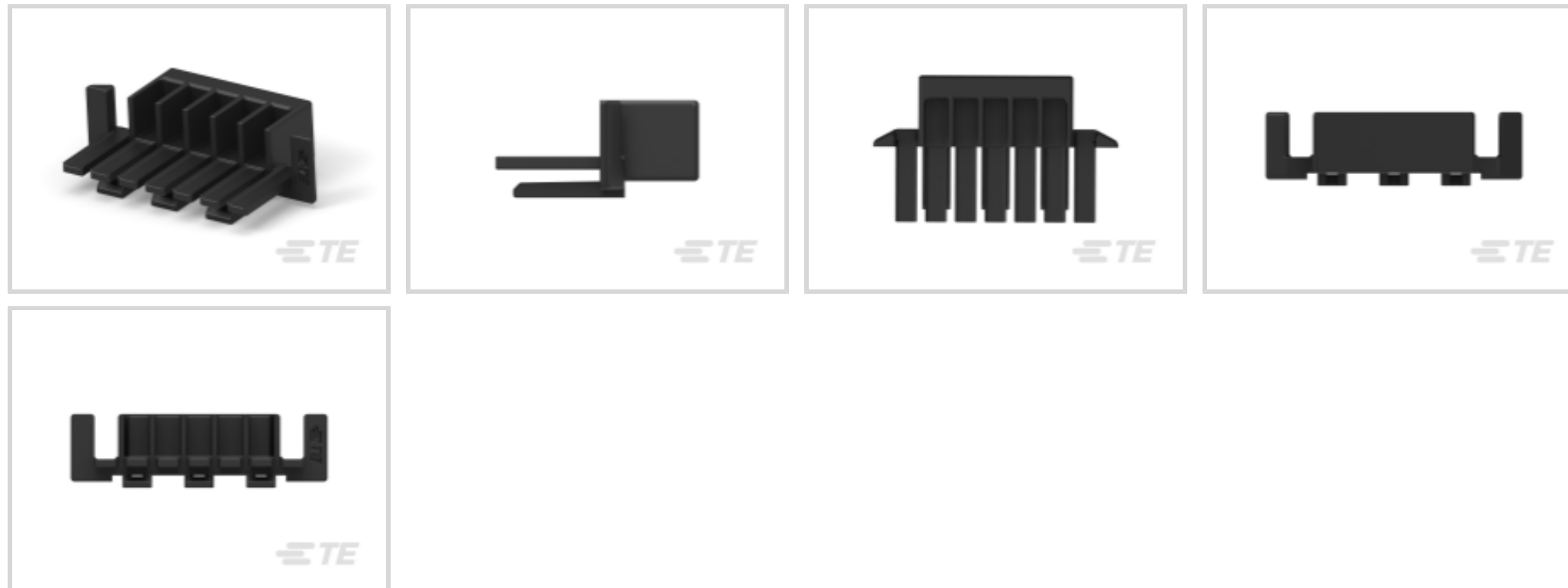

Connectors > Connector Accessories > Connector Hardware



Hardware Accessory Function: **Position Assurance**

Connector Hardware Accessory Type: **TPA (Terminal Position Assurance)**

Number of Positions: **7**

Operating Temperature (Max): **105 °C [ 221 °F ]**

Operating Temperature Range: **-55 – 105 °C [ -67 – 221 °F ]**

## Features

### Product Type Features

Hardware Accessory Function	Position Assurance
Connector Hardware Accessory Type	TPA (Terminal Position Assurance)

### Configuration Features

Number of Rows	1
Number of Positions	7

### Housing Features

Centerline (Pitch)	2.5 mm [.098 in]
--------------------	------------------

### Usage Conditions

Operating Temperature (Max)	105 °C [221 °F]
Operating Temperature Range	-55 – 105 °C [-67 – 221 °F]

## Product Compliance

[For compliance documentation, visit the product page on TE.com>](#)

EU RoHS Directive 2011/65/EU	Compliant
EU ELV Directive 2000/53/EC	Compliant



China RoHS 2 Directive MIIT Order No 32, 2016	No Restricted Materials Above Threshold
EU REACH Regulation (EC) No. 1907/2006	Current ECHA Candidate List: JAN 2025 (247) Candidate List Declared Against: JAN 2025 (247) Does not contain REACH SVHC
Halogen Content	Not Low Halogen - contains Br or Cl > 900 ppm.
Solder Process Capability	Not reviewed for solder process capability

Product Compliance Disclaimer

This information is provided based on reasonable inquiry of our suppliers and represents our current actual knowledge based on the information they provided. This information is subject to change. The part numbers that TE has identified as EU RoHS compliant have a maximum concentration of 0.1% by weight in homogenous materials for lead, hexavalent chromium, mercury, PBB, PBDE, DBP, BBP, DEHP, DIBP, and 0.01% for cadmium, or qualify for an exemption to these limits as defined in the Annexes of Directive 2011/65/EU (RoHS2). Finished electrical and electronic equipment products will be CE marked as required by Directive 2011/65/EU. Components may not be CE marked. Additionally, the part numbers that TE has identified as EU ELV compliant have a maximum concentration of 0.1% by weight in homogenous materials for lead, hexavalent chromium, and mercury, and 0.01% for cadmium, or qualify for an exemption to these limits as defined in the Annexes of Directive 2000/53/EC (ELV). Regarding the REACH Regulation, the information TE provides on SVHC in articles for this part number is based on the latest European Chemicals Agency (ECHA) 'Guidance on requirements for substances in articles' posted at this URL: <https://echa.europa.eu/guidance-documents/guidance-on-reach>

## Compatible Parts



TE Part # 1-1969443-8  
EP 2.5 TPA Retainer, 18 Pos



TE Part # 1-1969443-0  
EP 2.5 TPA Retainer, 10 Pos



TE Part # 1-1969443-6  
EP 2.5 TPA Retainer, 16 Pos



TE Part # 1-1969443-5  
EP 2.5 TPA Retainer, 15 Pos



TE Part # 1-1969443-1  
EP 2.5 TPA Retainer, 11 Pos



TE Part # 1969443-7  
EP 2.5 TPA Retainer, 7 Pos



TE Part # 1-1969443-7  
EP 2.5 TPA Retainer, 17 Pos



TE Part # 1-1969443-3  
EP 2.5 TPA Retainer, 13 Pos

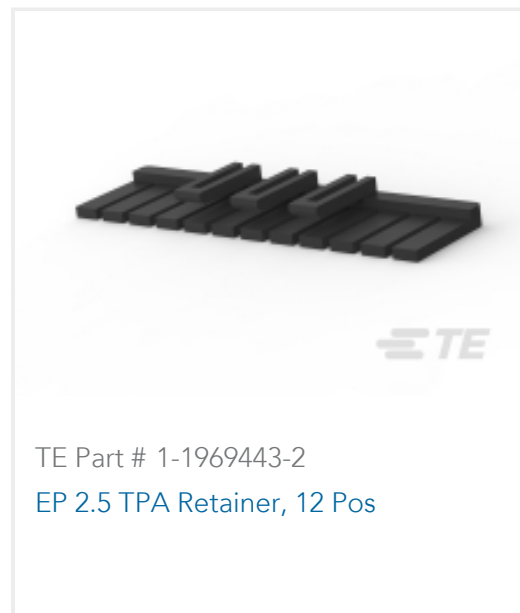

### Also in the Series | Economy Power 2.5

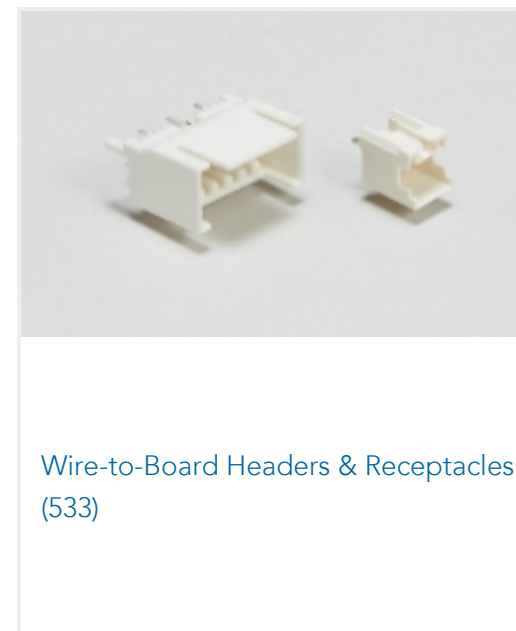
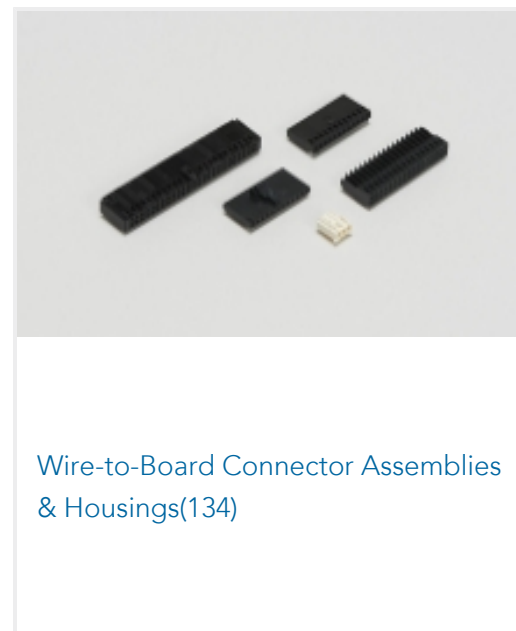
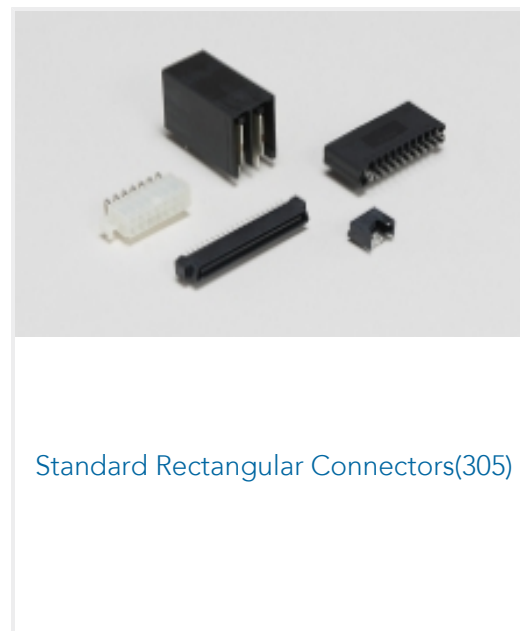
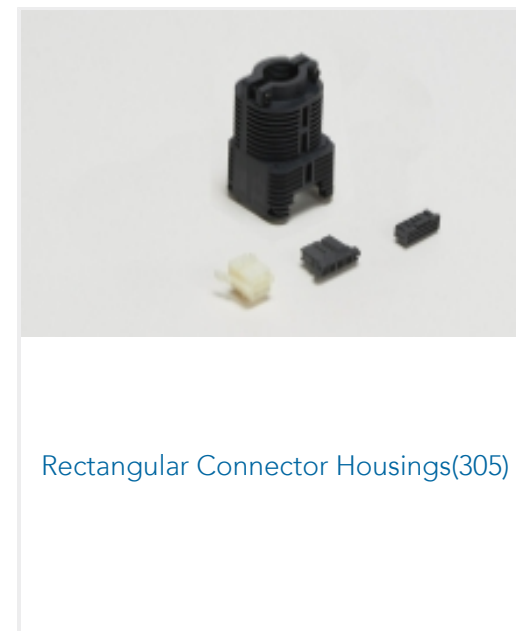
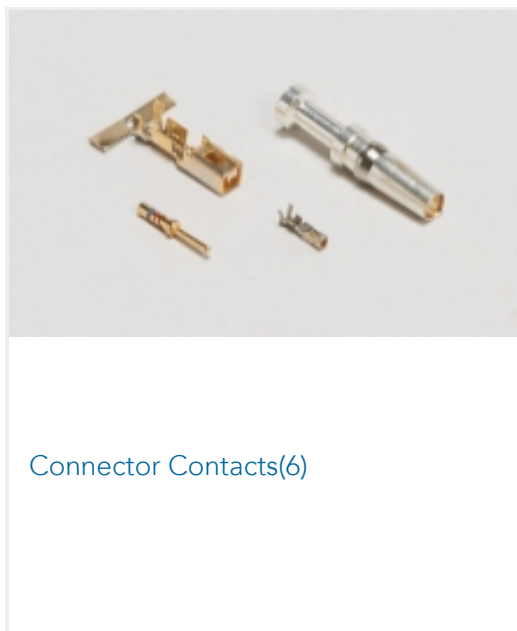

### Customers Also Bought

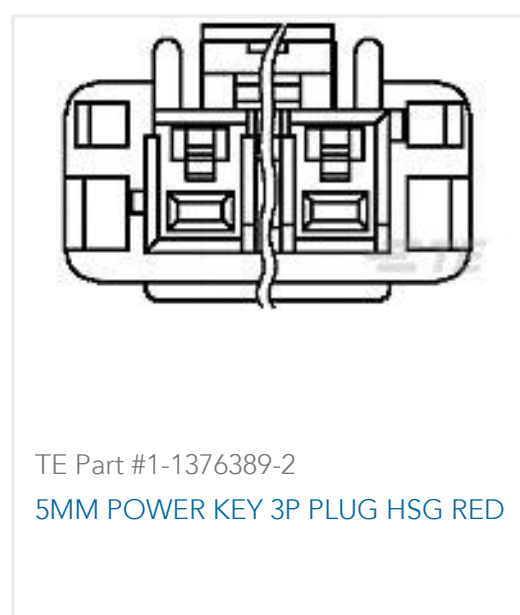
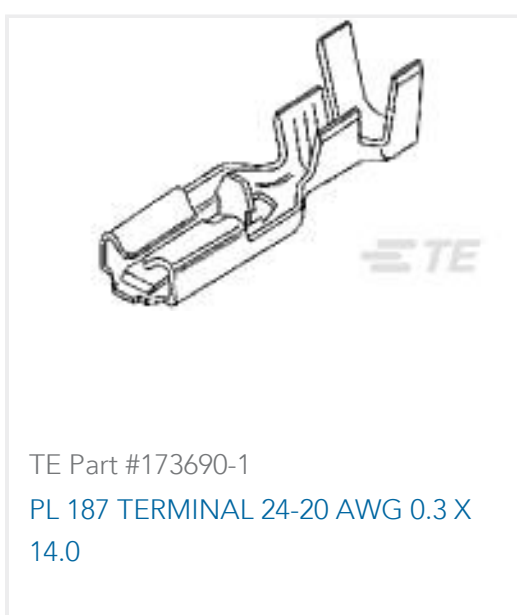



## Documents

### Product Drawings

[EP 2.5 TPA RETAINER, 7 POS](#)

English

### CAD Files

[3D PDF](#)

3D

Customer View Model

[ENG\\_CVM\\_CVM\\_1969825-7\\_B.2d\\_dxf.zip](#)

English

Customer View Model

[ENG\\_CVM\\_CVM\\_1969825-7\\_B.3d\\_igs.zip](#)

English

Customer View Model

[ENG\\_CVM\\_CVM\\_1969825-7\\_B.3d\\_stp.zip](#)

English

By downloading the CAD file I accept and agree to the [Terms and Conditions](#) of use.

### Datasheets & Catalog Pages

[7-1773461-6\\_EP2.5\\_Connector\\_Series](#)

English

### Product Specifications

[Application Specification](#)

English

### Instruction Sheets

[Instruction Sheet \(U.S.\)](#)

English

### Agency Approvals

[VDE Certificate](#)

English