



**AMP Universal Power**

TE Internal #: 176274-2

Rectangular Power Connectors, Housing, Plug, Wire-to-Wire, 6 Position, 3.96 mm [.156 in] Centerline, Wire & Cable, UL 94V-0, AMP Universal Power

[View on TE.com >](#)

Connectors > Power Connectors > Rectangular Power > Rectangular Power Connectors

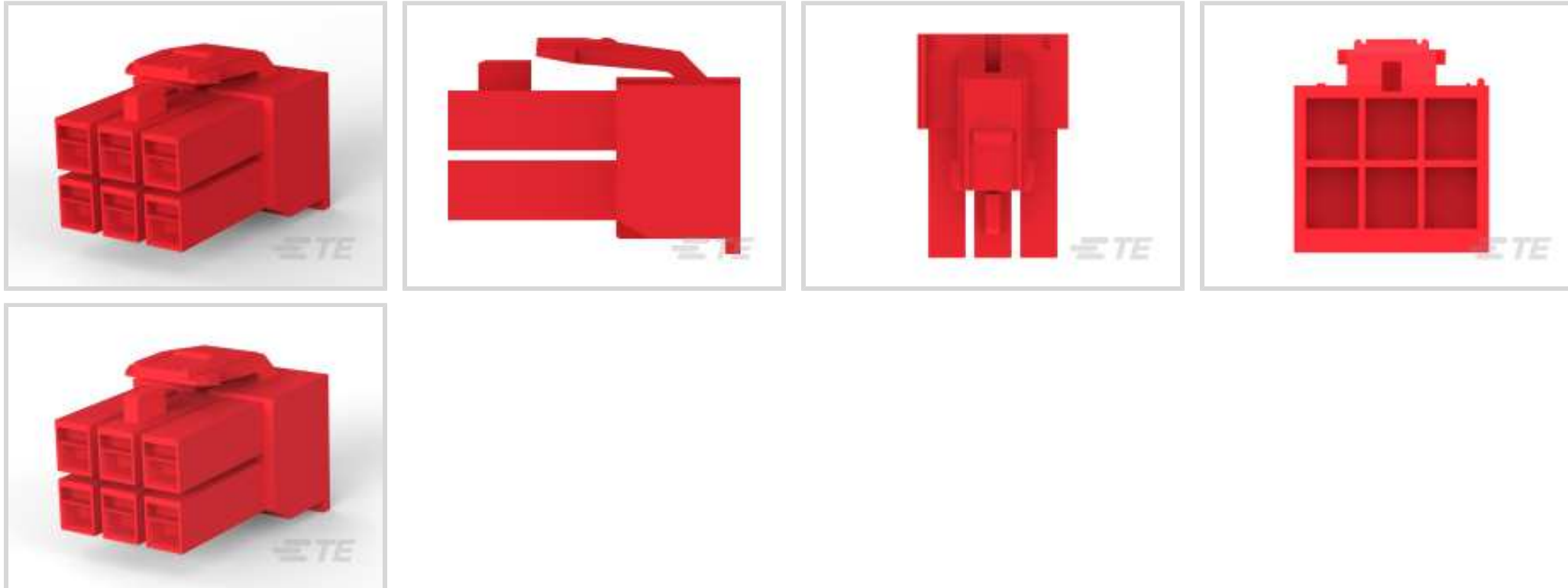

Rectangular Power Connector Type: **Housing**

Connector & Housing Type: **Plug**

Connector System: **Wire-to-Wire**

Number of Positions: **6**

Centerline (Pitch): **3.96 mm [.156 in]**

**Features**

**Product Type Features**

Rectangular Power Connector Type	Housing
Connector & Housing Type	Plug
Connector System	Wire-to-Wire
Sealable	No
Connector & Contact Terminates To	Wire & Cable

**Configuration Features**

Number of Positions	6
Number of Power Positions	0
Number of Signal Positions	0
Number of Rows	2

**Electrical Characteristics**

Operating Voltage	300 VAC
-------------------	---------

**Contact Features**

Contact Layout	Matrix
----------------	--------



Contact Retention Within Housing	Without
----------------------------------	---------

Contact Type	Receptacle
--------------	------------

### Termination Features

Termination Method to Wire & Cable	Crimp
------------------------------------	-------

### Mechanical Attachment

Strain Relief	Without
---------------	---------

Mating Alignment Type	Polarization
-----------------------	--------------

Mating Retention	With
------------------	------

Mating Alignment	With
------------------	------

Panel Mount Feature	Without
---------------------	---------

PCB Mount Retention	Without
---------------------	---------

Mating Retention Type	Latch
-----------------------	-------

Connector Mounting Type	Cable Mount (Free-Hanging)
-------------------------	----------------------------

### Housing Features

Centerline (Pitch)	3.96 mm [.156 in]
--------------------	-------------------

Housing Color	Red
---------------	-----

Housing Material	Nylon 6/6
------------------	-----------

### Dimensions

Row-to-Row Spacing	4.6 mm [.181 in]
--------------------	------------------

### Usage Conditions

Operating Temperature Range	-30 – 105 °C [-22 – 221 °F]
-----------------------------	-----------------------------

### Operation/Application

Circuit Application	Power & Signal
---------------------	----------------

### Industry Standards

UL Flammability Rating	UL 94V-0
------------------------	----------

Glow Wire Rating	Standard Part - Not Glow Wire
------------------	-------------------------------

### Packaging Features

Packaging Quantity	1000
--------------------	------

Packaging Method	Bag
------------------	-----

### Product Compliance

[For compliance documentation, visit the product page on TE.com>](#)



EU RoHS Directive 2011/65/EU	Compliant
EU ELV Directive 2000/53/EC	Compliant
China RoHS 2 Directive MIIT Order No 32, 2016	No Restricted Materials Above Threshold
EU REACH Regulation (EC) No. 1907/2006	Current ECHA Candidate List: JAN 2023 (233) Candidate List Declared Against: JUNE 2022 (224) Does not contain REACH SVHC
Halogen Content	BFR/CFR/PVC Free, but Br/Cl >900 ppm in other sources.
Solder Process Capability	Not applicable for solder process capability

Product Compliance Disclaimer

This information is provided based on reasonable inquiry of our suppliers and represents our current actual knowledge based on the information they provided. This information is subject to change. The part numbers that TE has identified as EU RoHS compliant have a maximum concentration of 0.1% by weight in homogenous materials for lead, hexavalent chromium, mercury, PBB, PBDE, DBP, BBP, DEHP, DIBP, and 0.01% for cadmium, or qualify for an exemption to these limits as defined in the Annexes of Directive 2011/65/EU (RoHS2). Finished electrical and electronic equipment products will be CE marked as required by Directive 2011/65/EU. Components may not be CE marked. Additionally, the part numbers that TE has identified as EU ELV compliant have a maximum concentration of 0.1% by weight in homogenous materials for lead, hexavalent chromium, and mercury, and 0.01% for cadmium, or qualify for an exemption to these limits as defined in the Annexes of Directive 2000/53/EC (ELV). Regarding the REACH Regulation, the information TE provides on SVHC in articles for this part number is based on the latest European Chemicals Agency (ECHA) 'Guidance on requirements for substances in articles' posted at this URL: <https://echa.europa.eu/guidance-documents/guidance-on-reach>

## Compatible Parts

 <p>TE Part # 175156-2 U/P REC CONT L/P</p>	 <p>TE Part # 176295-1 UNIV POWER CAP HSG 6P P/MOUNT</p>	 <p>TE Part # 175155-1 UNIV POWER REC CONT L/P</p>	 <p>TE Part # 176285-1 AMP UNIVERSAL POWER CAP 6P</p>
 <p>TE Part # 176285-6 AMP UNIVERSAL POWER CAP 6P</p>	 <p>TE Part # 175151-1 AMP UNIVERSAL POWER REC CONT.</p>	 <p>TE Part # 175152-1 UNIVERSAL POWER REC</p>	 <p>TE Part # 175151-2 AMP UNIVE. POWER CONN REC CONT</p>

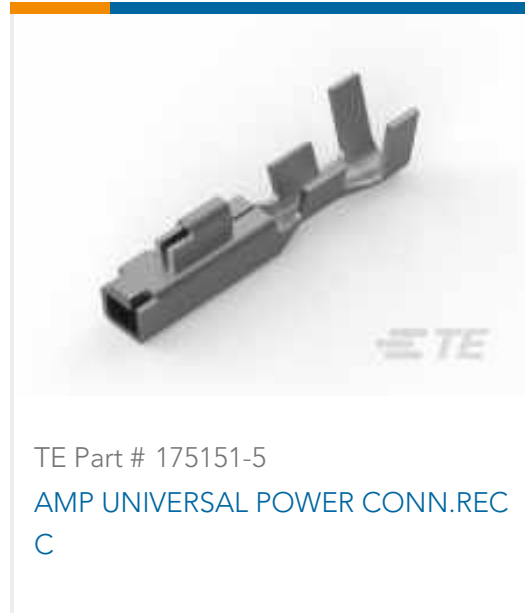

Also in the Series | AMP Universal Power

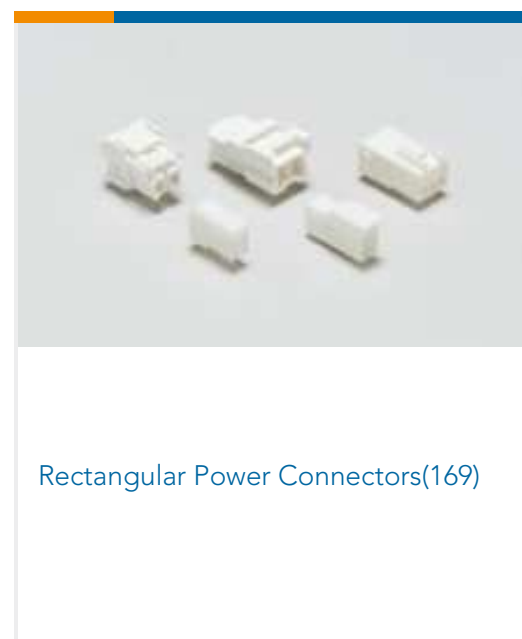
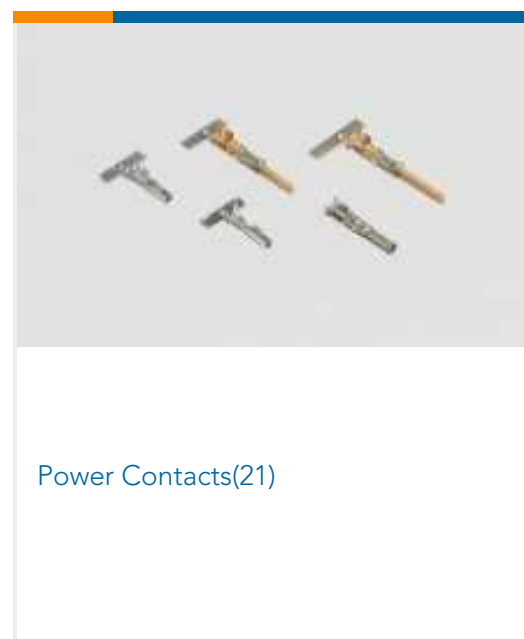
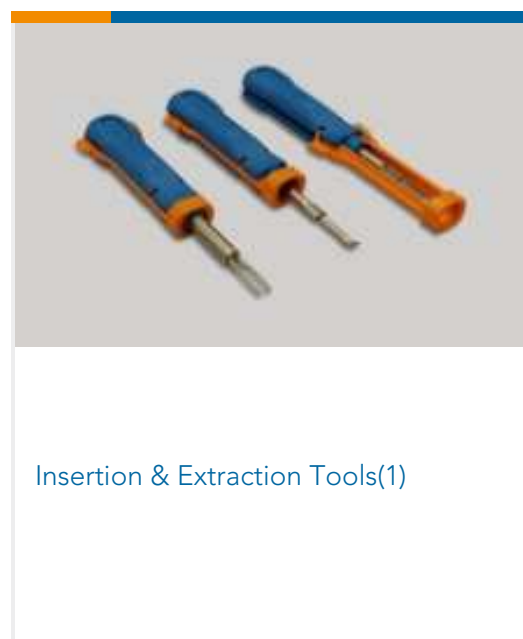
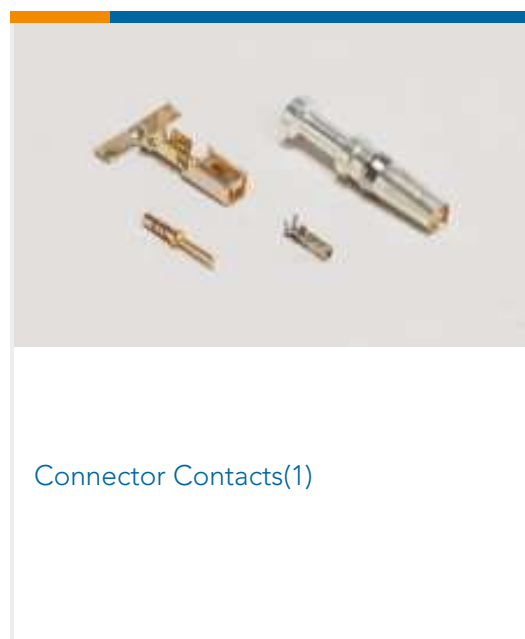

Customers Also Bought



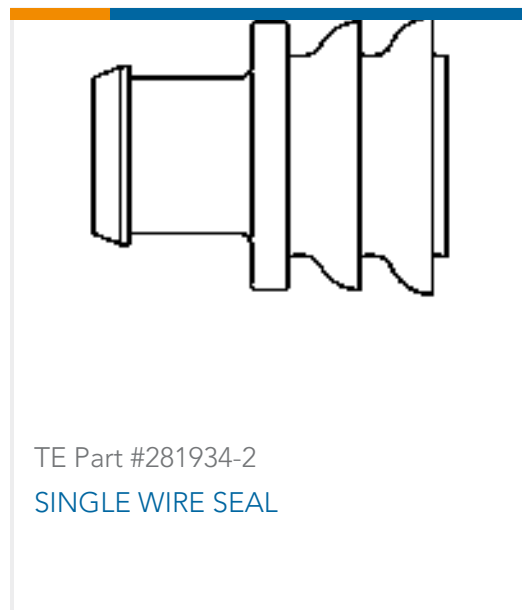

## Documents

### Product Drawings

#### AMP UNIVERSAL POWER PLUG 6P

English

### CAD Files

#### 3D PDF

3D

#### Customer View Model

[ENG\\_CVM\\_CVM\\_176274-2\\_G.2d\\_dxf.zip](#)

English

#### Customer View Model

[ENG\\_CVM\\_CVM\\_176274-2\\_G.3d\\_igs.zip](#)

English

#### Customer View Model

[ENG\\_CVM\\_CVM\\_176274-2\\_G.3d\\_stp.zip](#)

English

By downloading the CAD file I accept and agree to the [Terms and Conditions](#) of use.

### Product Specifications

#### Crimping of Universal Power Contact

English

#### Product Specification

Japanese

#### AMP Universal Power Connector

Japanese

### Product Environmental Compliance

[MD\\_176274-2\\_02252019115\\_dmtec](#)

English

[MD\\_176274-2\\_02252019115\\_dmtec](#)

English

### Instruction Sheets

#### AMP UNIVERSAL POWER CONNECTOR SERIES

English

#### Instruction Sheet (non U.S.)



English

---

[Agency Approvals](#)

[UL Report](#)

English