

1670174-3 ✓ ACTIVE

AMP | Timer Connector System

TE Internal #: 1670174-3

Housing for Male Terminals, Wire-to-Board, 102 Position, .228 in / .169 in [4.3 mm / 5.8 mm] Centerline, Black, Wire & Cable, Timer Connector System

[View on TE.com >](#)



Connectors > Automotive Connectors > Automotive Housings



Connector System: **Wire-to-Board**

Number of Positions: **102**

Connector & Housing Type: **Housing for Male Terminals**

Centerline (Pitch): **4.3 mm, 5.8 mm [ .169 in, .228 in ]**

Sealable: **No**

### Features

#### Product Type Features

Mixed & Hybrid Connector	Yes
Connector Shape	Rectangular
Connector System	Wire-to-Board
Connector & Housing Type	Housing for Male Terminals
Sealable	No
Connector & Contact Terminates To	Wire & Cable
Primary Locking Feature	On the Terminal

#### Configuration Features

Number of Positions	102
Number of Rows	11

#### Electrical Characteristics

Nominal Voltage Architecture	12 V, 24 V
------------------------------	------------

#### Body Features

Primary Product Color	Black
-----------------------	-------



Connector & Keying Code	Neutral
-------------------------	---------

### Contact Features

Contact Size	1.6mm, 2.8mm, 9.5mm
Contact Type	Tab
Contact Current Rating (Max)	10 A, 30 A, 40 A

### Mechanical Attachment

Mating Alignment Type	Polarized
Mating Alignment	With
Connector Mounting Type	Cable Mount (Free-Hanging)

### Housing Features

Centerline (Pitch)	4.3 mm, 5.8 mm [.169 in] [.228 in]
--------------------	------------------------------------

### Packaging Features

Packaging Method	Package
------------------	---------

### Other

Connector Position Assurance Capable	No
--------------------------------------	----

## Product Compliance

[For compliance documentation, visit the product page on TE.com>](#)

EU RoHS Directive 2011/65/EU	Compliant
EU ELV Directive 2000/53/EC	Compliant
China RoHS 2 Directive MIIT Order No 32, 2016	No Restricted Materials Above Threshold
EU REACH Regulation (EC) No. 1907/2006	Current ECHA Candidate List: JAN 2024 (240) Candidate List Declared Against: JAN 2024 (240) Does not contain REACH SVHC
Halogen Content	Low Halogen - Br, Cl, F, I < 900 ppm per homogenous material. Also BFR/CFR/PVC Free
Solder Process Capability	Not reviewed for solder process capability

#### Product Compliance Disclaimer

This information is provided based on reasonable inquiry of our suppliers and represents our current actual knowledge based on the information they provided. This information is subject to change. The part numbers that TE has identified as EU RoHS compliant have a maximum concentration of 0.1% by weight in homogenous materials for lead, hexavalent chromium, mercury, PBB, PBDE, DBP, BBP, DEHP, DIBP, and 0.01% for cadmium, or qualify for an exemption to these limits as defined in the Annexes of Directive 2011/65/EU (RoHS2). Finished electrical and electronic equipment products

will be CE marked as required by Directive 2011/65/EU. Components may not be CE marked. Additionally, the part numbers that TE has identified as EU ELV compliant have a maximum concentration of 0.1% by weight in homogenous materials for lead, hexavalent chromium, and mercury, and 0.01% for cadmium, or qualify for an exemption to these limits as defined in the Annexes of Directive 2000/53/EC (ELV). Regarding the REACH Regulation, the information TE provides on SVHC in articles for this part number is based on the latest European Chemicals Agency (ECHA) 'Guidance on requirements for substances in articles' posted at this URL: <https://echa.europa.eu/guidance-documents/guidance-on-reach>

## Compatible Parts



TE Part # 1355702-2  
SCHIEBER F.LN+RE



TE Part # 1670173-2  
102POS,MIXED,TAB HSG,BK

## Also in the Series | Timer Connector System



Automotive Connector Caps & Covers (14)

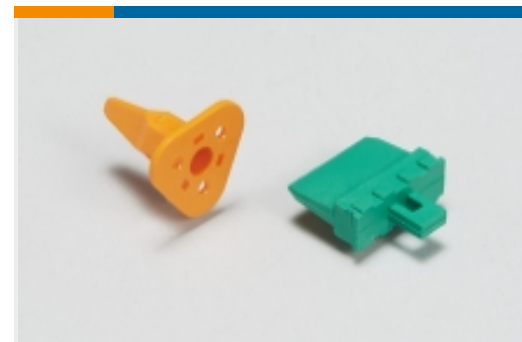

Automotive Connector Locks & Position Assurance(15)



Automotive Housings(214)



Automotive Terminals(136)



Connector Seals & Cavity Plugs(38)



Crimp Terminal Housings(13)



Insertion & Extraction Tools(18)



Other Automotive Connector Accessories(1)



PCB Headers & Receptacles(40)

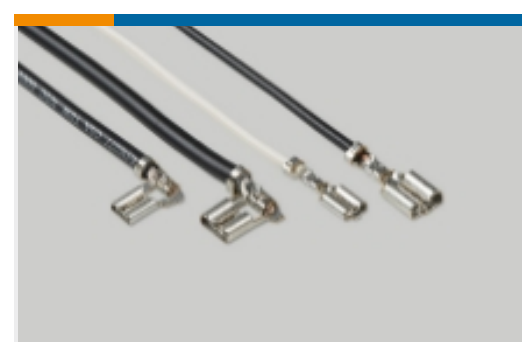

Quick Disconnects(4)

## Customers Also Bought

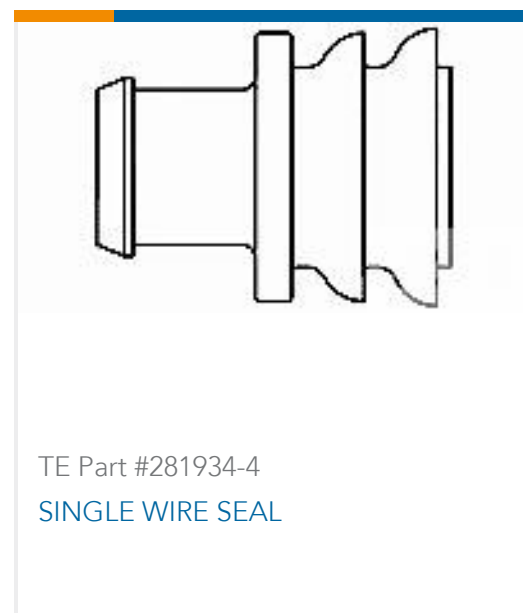

## Documents

### CAD Files

#### Customer View Model

[ENG\\_CVM\\_CVM\\_1670174-3\\_B.2d\\_dxf.zip](#)

English

#### 3D PDF

3D

#### Customer View Model

[ENG\\_CVM\\_CVM\\_1670174-3\\_B.3d\\_igs.zip](#)

English

#### Customer View Model

[ENG\\_CVM\\_CVM\\_1670174-3\\_B.3d\\_stp.zip](#)

English

By downloading the CAD file I accept and agree to the [Terms and Conditions](#) of use.