

NUMERO SUPPLEMENT
 15 1937

 OBSOLETE

SECTION A-A

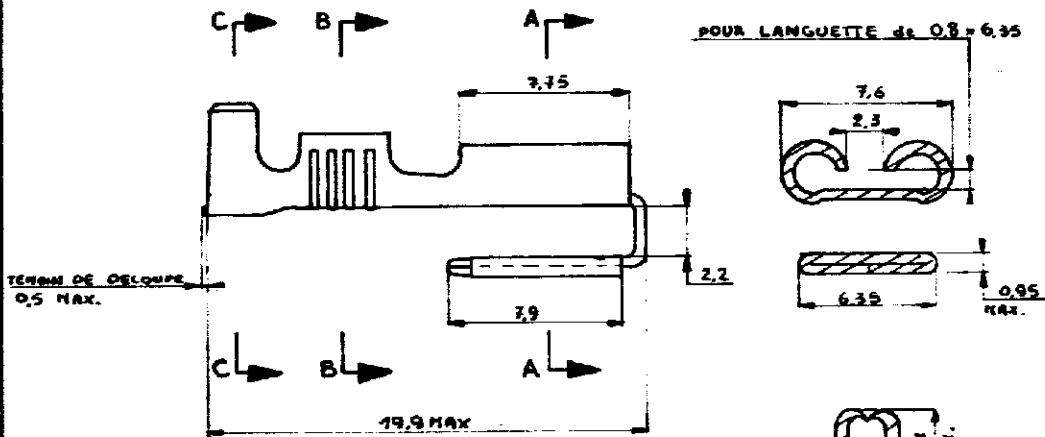

POUR LANGUETTE de 0.8 - 6.35

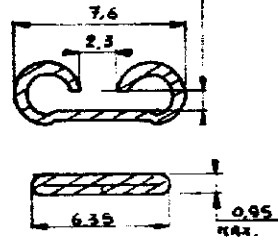



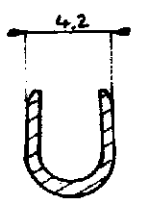

SECTION B-B

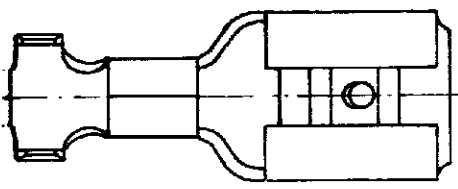

SECTION C-C



151 937 - 7	150 645 - 7	ACIER ETAME
151 937 - 6 	150 645 - 6	BRONZE PHOSPHOREUX ETAME
151 937 - 5	150 645 - 5 	ACIER NICKELÉ
151 937 - 4	150 645 - 4	ACIER
151 937 - 3	150 645 - 3	LAITON ETAME
151 937 - 2 	150 645 - 2	LAITON
151 937 - 1	150 645 - 1 	BRONZE PHOSPHOREUX
NUMERO VAAC	NUMERO PIÈCES EN BANDE	MATIERE FINITION

LES COTES SONT DONNEES EN mm ET NE DOIVENT PAS ETRE RELEVES A L'ECHELLE SUR LE DESSIN

14

© 1994 AMM INCORPORATED. ALL RIGHTS RESERVED. ALL PRODUCTS COVERED BY PATENTS AND OR PATENTS PENDING.		DESSIN CLIENT UNIQUEMENT POUR REFERENCES	
MATIERE ET FINITION			
DIMENS - FIL 32 4,3mm		CLASSE	
TOLERANCES SAUF INDICATION		ECHELLE	
INC CHANGEMENT DES VER DATE		INC SUPPLEMENT F A C151937	
DESSIN 10-3-75 MENAGER		APPROUVE	
CLIP AVEC LANGUETTE 6.35 VRAC			