

1-1703082-1 ✓ ACTIVE

RAST | RAST 5D, RAST 5 IDC Connectors

TE Internal #: 1-1703082-1

Wire-to-Board Card Edge Housing, 3 Position, 5 mm [.197 in]

Centerline, Wire & Cable, Power & Signal, RAST 5 IDC Connectors

[View on TE.com >](#)



Connectors > PCB Connectors > Card Edge Connectors > Card Edge Connector Housings



Connector System: **Wire-to-Board**

Number of Positions: **3**

Centerline (Pitch): **5 mm [.197 in]**

Connector & Contact Terminates To: **Wire & Cable**

Circuit Application: **Power & Signal**

Features

Product Type Features

Connector System	Wire-to-Board
Connector & Contact Terminates To	Wire & Cable

Configuration Features

Number of Positions	3
---------------------	---

Body Features

Primary Product Color	Natural
-----------------------	---------

Mechanical Attachment

Connector Mounting Type	Board Mount
-------------------------	-------------

Housing Features

Housing Material	PA 6.6
Centerline (Pitch)	5 mm [.197 in]

Usage Conditions

Operating Temperature Range	-40 – 105 °C [-40 – 221 °F]
-----------------------------	-----------------------------

Operation/Application



Circuit Application	Power & Signal
---------------------	----------------

Packaging Features

Packaging Method	Bag & Box
Packaging Quantity	2000

Product Compliance

[For compliance documentation, visit the product page on TE.com>](#)

EU RoHS Directive 2011/65/EU	Compliant
EU ELV Directive 2000/53/EC	Compliant
China RoHS 2 Directive MIIT Order No 32, 2016	No Restricted Materials Above Threshold
EU REACH Regulation (EC) No. 1907/2006	Current ECHA Candidate List: JAN 2025 (247) Candidate List Declared Against: JAN 2025 (247) Does not contain REACH SVHC
Halogen Content	Low Halogen - Br, Cl, F, I < 900 ppm per homogenous material. Also BFR/CFR/PVC Free
Solder Process Capability	Not reviewed for solder process capability

Product Compliance Disclaimer

This information is provided based on reasonable inquiry of our suppliers and represents our current actual knowledge based on the information they provided. This information is subject to change. The part numbers that TE has identified as EU RoHS compliant have a maximum concentration of 0.1% by weight in homogenous materials for lead, hexavalent chromium, mercury, PBB, PBDE, DBP, BBP, DEHP, DIBP, and 0.01% for cadmium, or qualify for an exemption to these limits as defined in the Annexes of Directive 2011/65/EU (RoHS2). Finished electrical and electronic equipment products will be CE marked as required by Directive 2011/65/EU. Components may not be CE marked. Additionally, the part numbers that TE has identified as EU ELV compliant have a maximum concentration of 0.1% by weight in homogenous materials for lead, hexavalent chromium, and mercury, and 0.01% for cadmium, or qualify for an exemption to these limits as defined in the Annexes of Directive 2000/53/EC (ELV). Regarding the REACH Regulation, the information TE provides on SVHC in articles for this part number is based on the latest European Chemicals Agency (ECHA) 'Guidance on requirements for substances in articles' posted at this URL: <https://echa.europa.eu/guidance-documents/guidance-on-reach>

Compatible Parts





Also in the Series | **RAST 5D**

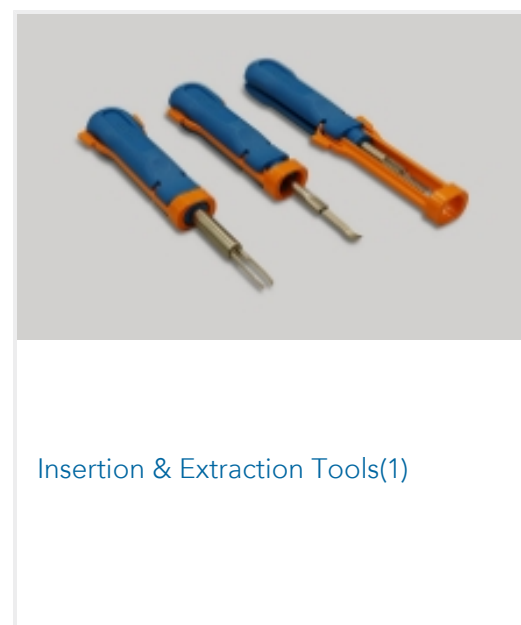
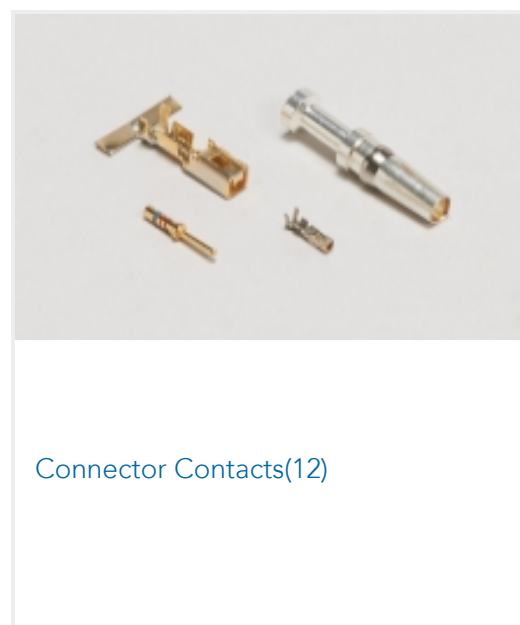
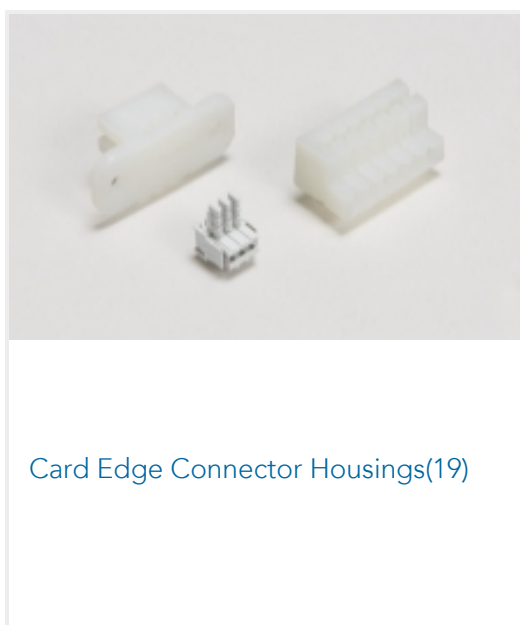



Power Contacts(3)



Rectangular Power Connectors(658)

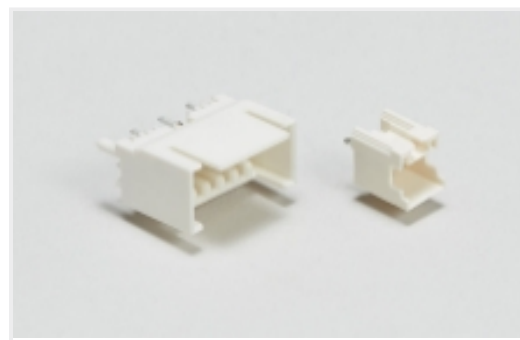

Wire-to-Board Headers & Receptacles (418)

Also in the Series | **RAST 5 IDC Connectors**

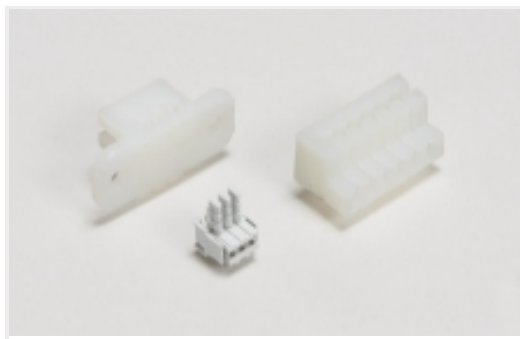

Card Edge Connector Housings(19)

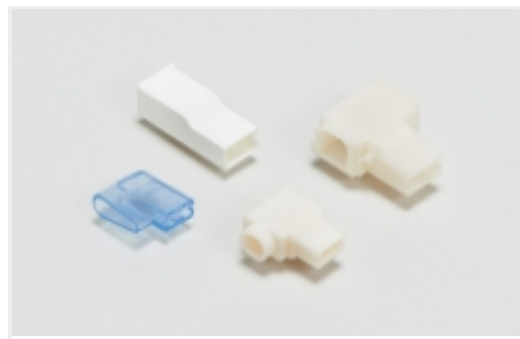

Crimp Terminal Housings(39)

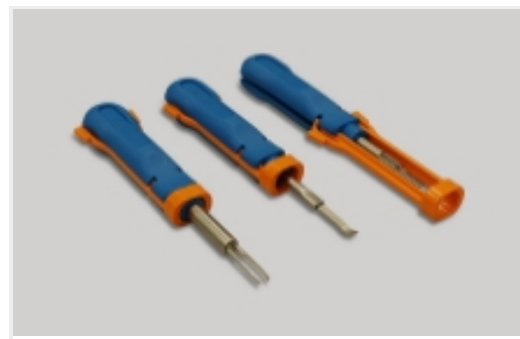

Insertion & Extraction Tools(1)

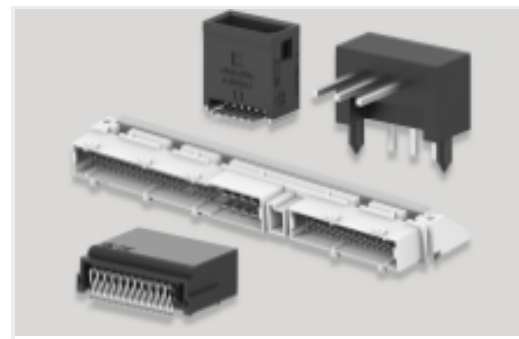

PCB Headers & Receptacles(418)



Rectangular Power Connectors(658)

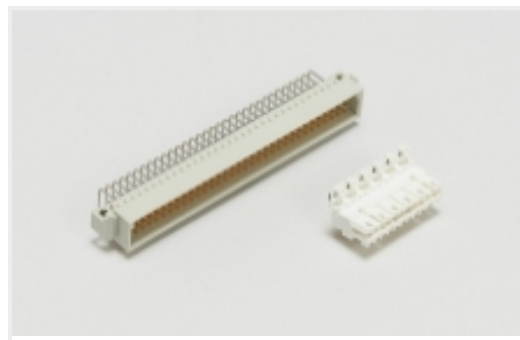

Standard Edge Connectors(31)

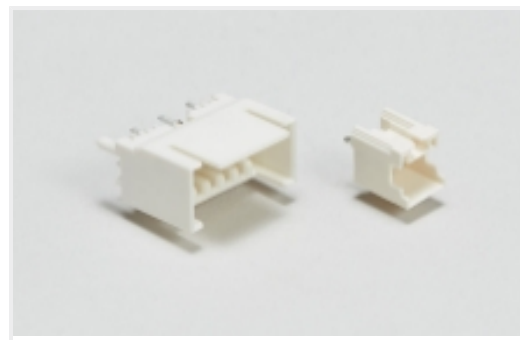

Wire-to-Board Headers & Receptacles (418)

Customers Also Bought



TE Part #CAT-D48-ST273
DEUTSCH Solid Contacts



TE Part #CAT-D487-W416
Wedgelocks: DEUTSCH DT



TE Part #DT06-2S
PLG, 2P, GRY, N



TE Part #DT04-2P
REC, 2P, GRY, N



TE Part #114017-ZZ
SEALING PLUG, SIZE 12/16, WHT

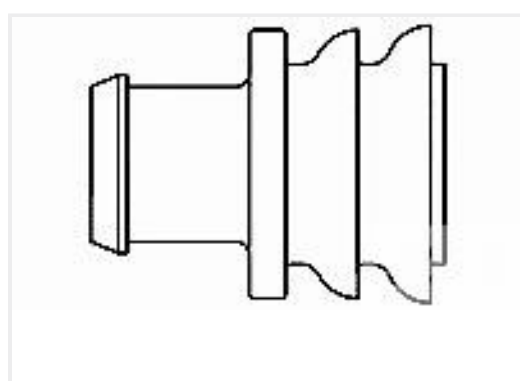

TE Part #281934-2
SINGLE WIRE SEAL



TE Part #CAT-AM71-CH8172
AMP SUPERSEAL 1.5MM,
CONNECTOR HOUSING



Documents

Product Drawings

3POS MT - EDGE HOUSING

English

CAD Files

3D PDF

3D

Customer View Model

[ENG_CVM_CVM_1-1703082-1_C.2d_dxf.zip](#)

English

Customer View Model

[ENG_CVM_CVM_1-1703082-1_C.3d_igs.zip](#)

English

Customer View Model

[ENG_CVM_CVM_1-1703082-1_C.3d_stp.zip](#)

English

By downloading the CAD file I accept and agree to the [Terms and Conditions](#) of use.

Datasheets & Catalog Pages

RAST Connector System Catalog

English