

### HIGHLIGHTS

#### FEATURES

- Altech DIN Rails comply with DIN EN60715, EN50022, EN50035, EN50045 standards
- Easy mounting of terminal blocks, power supplies and other control components and devices into panel
- Space saving
- Reduces labor
- 35mm, 32mm and 15mm versions
- 1m and 2m standard length
- Custom length available
- Perforated, unperforated

#### MATERIAL

- Zinc-plated steel
  - 35x7.5mm
  - 35x15mm
  - 32mm
  - 15mm
- Aluminum
  - 35x7.5mm
- Stainless Steel (Type AISI 304)
  - 35x7.5mm

### DIN35 x 7.5

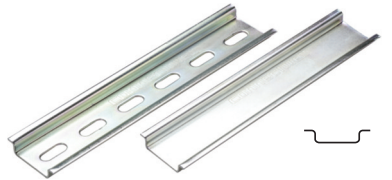

35 mm x  
7.5 mm deep

#### Zinc Plated Steel

Type	Cat. No.	Length	Std. Pk.
Perforated	2511120	2m	20
	2511120/1M	1m	40
Unperforated	2511110	2m	20
	2511110/1M	1m	40

#### Stainless Steel

Type	Cat. No.	Length	Std. Pk.
Perforated	2511125	2m	20
	2511125/1M	1m	40
Unperforated	2511115	2m	20
	2511115/1M	1m	40

#### Aluminum

Type	Cat. No.	Length	Std. Pk.
Perforated	2511121	2m	20
	2511121/1M	1m	40
Unperforated	2511111	2m	20
	2511111/1M	1m	40

### DIN35 x 15

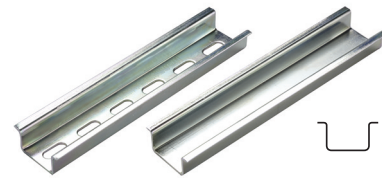

35 mm x  
15 mm deep

#### Zinc Plated Steel

Type	Cat. No.	Length	Std. Pk.
Perforated	CA701-15/S-2M	2m	20
	CA701-15/S	1m	40
Unperforated	CA701-15-2M	2m	20
	CA701-15	1m	40

### Dimensions

#### Perforated Steel and Stainless

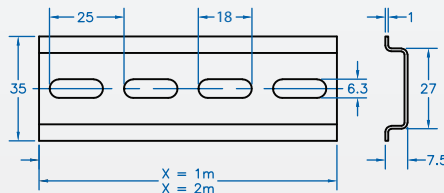

#### Perforated Steel

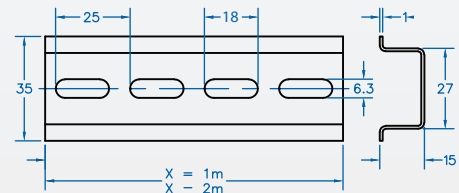

#### Perforated Aluminum

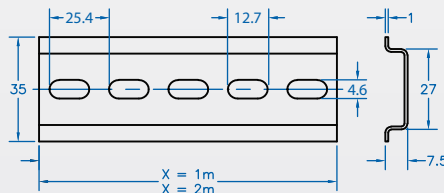

#### Unperforated Steel

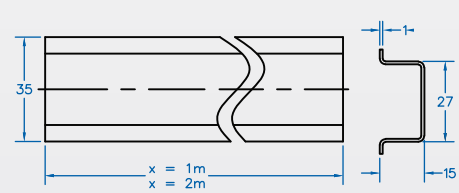

#### Unperforated

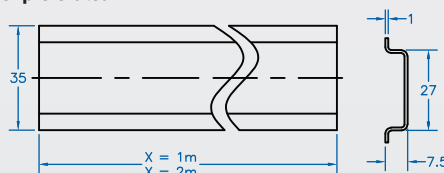

### DIN RAIL

#### DIN32

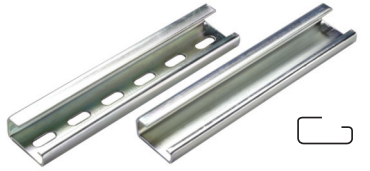

32 mm x  
15 mm deep

#### Zinc Plated Steel

Type	Cat. No.	Length	Std. Pk.
Perforated	2511160	2m	10
	2511160/1M	1m	20
Unperforated	2511150	2m	10
	2511150/1M	1m	20

#### DIN15

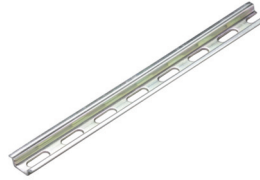

15 mm x  
5.5 mm deep

#### Zinc Plated Steel

Type	Cat. No.	Length	Std. Pk.
Perforated	CA601/S	2m	20

### Dimensions

#### Perforated Steel

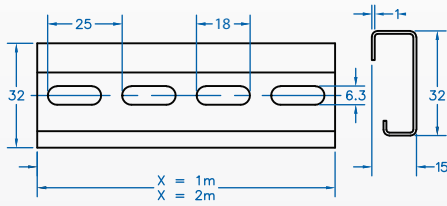

#### Perforated Steel

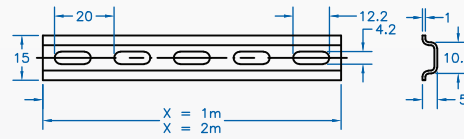

#### Unperforated Steel

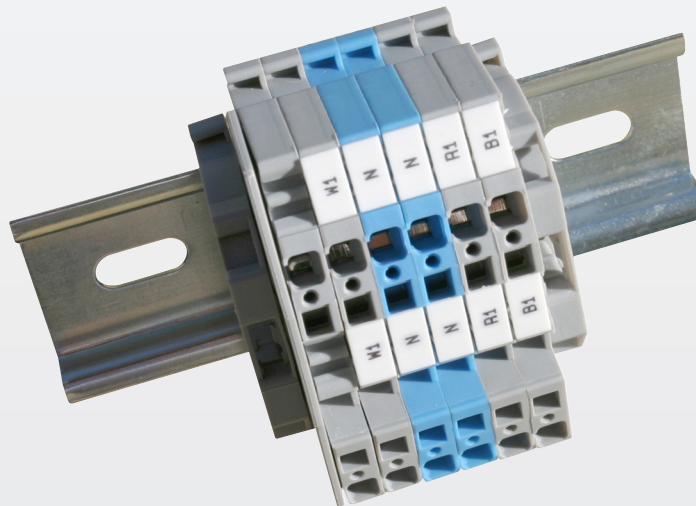
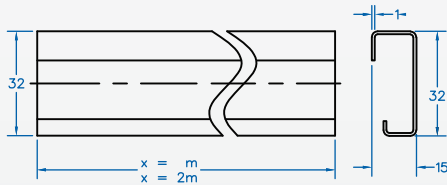

### HIGHLIGHTS

#### SUPPORT BRACKETS

- Elevate DIN Rail away from panel
- Easier mounting of components
- Suitable for all mounting rails
- Increase wiring access
- 45° version for improved visibility
- Straight brackets available in 3 heights:
  - 1"
  - 2"
  - 3"

#### MOUNTING

- Brackets mount with 2 screws to any panel or flat surface
- Tapped center hole for DIN Rail mounting

#### MATERIAL

- Zinc-plated yellow chromated Steel

#### UNIVERSAL DIN CLIPS

- Clips on to any 35mm/32mm DIN Rail
- Flexible mounting solution
- Mount any component on 32mm/35mm DIN Rail
- Various mounting hole solutions
- Material: zinc-plated steel, Polyamide 66

#### SPACER

- Increases creepage and clearance distance between terminal blocks
- Segregate different groups of terminal blocks

#### WARNING LABELS

- Mounted on top of terminal block for visual identification
- Make entire terminal block assembly shock-proof

### SUPPORT BRACKETS



Cat. No.	Std. Pk.
CA603	25

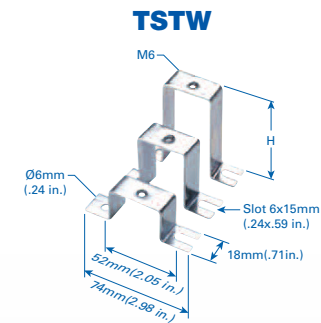

Cat. No.	Height	Std. Pk.
CA703	1 in.	25
CA803	2 in.	25
CA903	3 in.	25

### UNIVERSAL DIN CLIPS

#### D35CLIP



Cat. No.	Mounting Hole	Std. Pk.
D35CLIP-M4	M4	100
D35CLIP-M5	M5	100

#### CMTB35

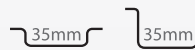
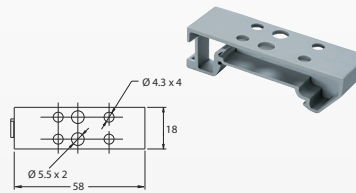

Cat. No.	Mounting Hole	Std. Pk.
CMTB35	2x4.4 mm	50
	2x5.5 mm	

#### CA902

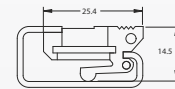

Cat. No.	Std. Pk.
CA902	100

### SPACER

#### CASP



Cat. No.	Dimensions	Std. Pk.
CASP	29 x 43 x 8 mm	50

#### CDL4U SPACER

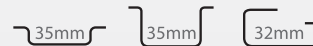
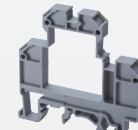

Cat. No.	Dimensions	Std. Pk.
CDL4USP	54 x 55.5 x 6 mm	50

### WARNING LABELS

Cat. No.	Terminal Blocks	Pack	Std. Pk. Strips	Tags
WLX2.5	CX2.5 Series, CXDL2.5, CXK2.5, CXM2.5	1	20	100
WLX4	CX4 Series, CXF Series, CXK4	1	20	100
WLX6	CX6 Series, CXDB Series	1	20	100
WLX10	CX10 Series	1	20	100
SWL4	CTS4U-N, CDB4, CMDB4	1	20	100
SWL10	CTS6U, CDB6U, CMDB6	1	20	100

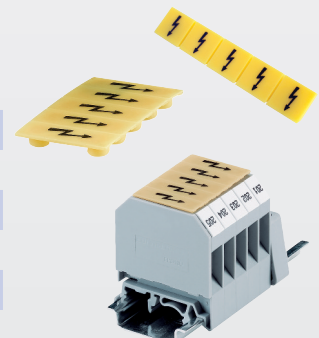

### END STOPS

#### Selection Table

DIN Rail Type	CA102	CA202	CA702	CA802	CA103	CA602	CA302	CA402	CA502
35x7.5mm DIN Rail	✓	✓	✓	✓	✓		✓		
35x15mm DIN Rail	✓	✓	✓	✓	✓			✓	
32mm DIN Rail	✓		✓						✓
15mm DIN Rail						✓			

#### HIGHLIGHTS

##### MOUNTING PINS

- End Stops prevent Terminal Blocks and other DIN Rail components from moving on the rail
- Versions for
  - 35x7.5mm Rail
  - 35x15mm Rail
  - 32mm Rail
  - 15mm Rail
- Heavy Duty End stop **CA102, CA202**
- Screwless End Stop **CA103** (snap on)
- Material:
  - Polyamide
  - Steel

### POLYAMIDE 66

#### CA702



Cat. No.	Dimensions	Std. Pk.
CA702	34 x 44 x 9mm	50

#### CA802

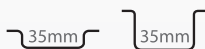
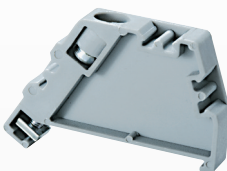

Cat. No.	Dimensions	Std. Pk.
CA802	32 x 45 x 8mm	50

#### CA202

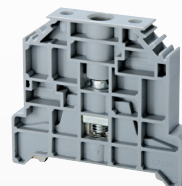

Heavy Duty End Stop



Cat. No.	Dimensions	Std. Pk.
CA202	44.5 x 50 x 9.5mm	50

#### CA102

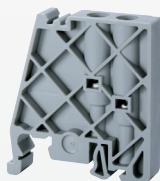

Cat. No.	Dimensions	Std. Pk.
CA102	46 x 50 x 9mm	50

#### CA103

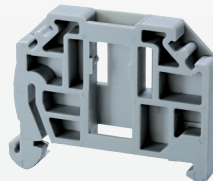

Screwless Snap-On

Cat. No.	Dimensions	Std. Pk.
CA103	41 x 35 x 6mm	50

#### CA602



Cat. No.	Dimensions	Std. Pk.
CA602	20 x 28 x 8mm	50

### STEEL

#### CA302



Cat. No.	Dimensions	Std. Pk.
CA302	27 x 39.5 x 16mm	50

#### CA402



Cat. No.	Dimensions	Std. Pk.
CA402	27 x 39.5 x 16mm	50

#### CA502



Cat. No.	Dimensions	Std. Pk.
CA502	25 x 22.5 x 11.5mm	50

### HIGHLIGHTS

#### FEATURES

- Group identification
- Holders fit standard **MT8** marking tags
- GMH6, GMH7 mounted directly on DIN Rail
- GMH1, GMH2, GMH3, GMH4, GMH5, GMH8 mounted on End Stops
- MT1G, MT2G, can be used with all these holders or can be directly mounted on all end stops
- Material: Polyamide 66

### DIN RAIL MOUNT

#### GMH6

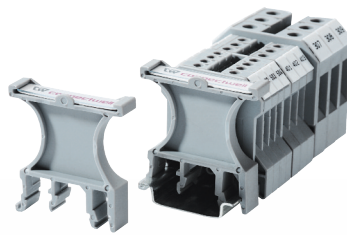

Cat. No.	Dimensions	Std. Pk.
GMH6	46.5 x 44.5 x 9.5mm	50

#### GMH7

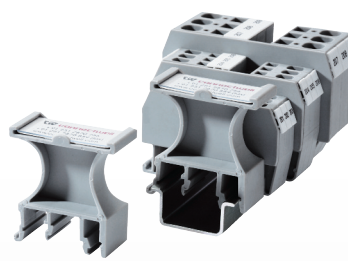

Cat. No.	Dimensions	Std. Pk.
GMH7	46.5 x 44.5 x 19.5mm	50

### MOUNT ON END STOP

#### GMH1

Suitable for CA602

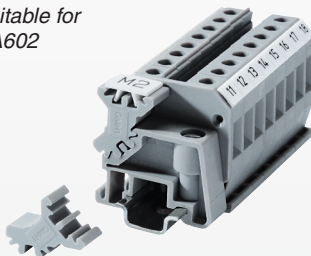

Cat. No.	Dimensions	Std. Pk.
GMH1	15.8 x 14.6 x 8mm	100

#### GMH4

Suitable for CA802

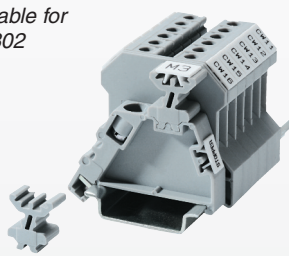

Cat. No.	Dimensions	Std. Pk.
GMH4	16.2 x 14 x 8mm	100

#### GMH5

Suitable for CA702

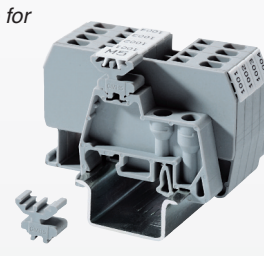

Cat. No.	Dimensions	Std. Pk.
GMH5	13.7 x 14 x 8mm	100

#### GMH2 / GMH3

Suitable for CA702 (GMH2)  
CA802 (GMH3)

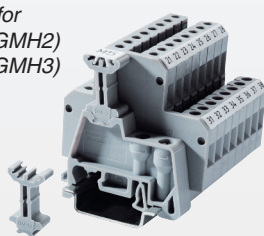

Cat. No.	Dimensions	Std. Pk.
GMH2	23.2 x 14 x 8mm	100
GMH3	23 x 14 x 8mm	100

#### GMH8 / GMH8N

Suitable for CA103

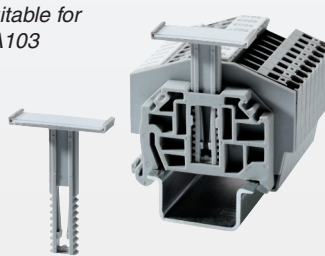

Cat. No.	Dimensions	Std. Pk.
GMH8	44.65 x 31.10 x 10mm	100
GMH8N	44.65 x 31.10 x 6mm	100

#### MTG1 / MTG2

Mountable on all End Clamps

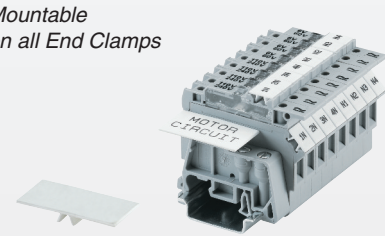

Cat. No.	Dimensions	Std. Pk.
MTG1	4.3 x 34 x 17.8mm	50
MTG2	4.3 x 34 x 8mm	50

#### TM5

Suitable for CXDL Series

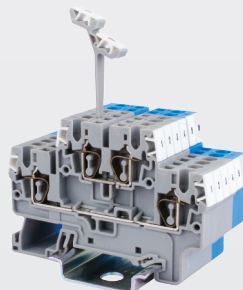

Cat. No.	Dimensions	Std. Pk.
TM5	38 x 17 x 5mm	50

### MARKING TAGS



- Cost Effective MT marking system for quick and accurate identification
- Push-On Tags fit all Altech DIN Rail mount terminal blocks
- Inserted individually or as strips of 10
- Quick and easy marking
- Blank Marking Tags for customer marking
- Order with horizontal/ vertical imprint
- Standard imprints with consecutive or identical numbers/ characters
- Custom imprint with short lead time
- Supplied in packs of 100 tags/ 10 strips

### BLANK MARKING TAGS

Cat No./ Type	Standard Packs			Dimensions	
	Pack	Strips	Tags	H	W
MT2	1	10	100	4.9mm	5.8mm
MT3	1	20	100	5.0mm	10.0mm
MT4	1	10	100	5.0mm	4.8mm
MT5	1	10	100	9.5mm	4.5mm
MT6	1	10	100	9.5mm	5.6mm
MT8	1	10	100	10.5mm	7.5mm
MT9	1	10	100	10.3mm	8.7mm
MT10	1	20	100	10.4mm	9.5mm
MT12	1	20	100	10.4mm	11.4mm
MT16	1	20	100	10.5mm	15.4mm
MT2G	1	10	100	5.0mm	5.0mm
MT2B4	1	10	100	5.8mm	9.1mm
<b>Continuous Tags</b>					
MT6F	1	10	10	9.5mm	60.0mm
MT9F	1	10	10	10.3mm	90.0mm

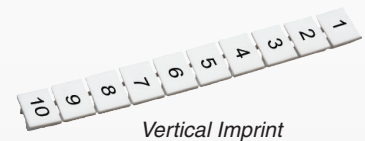

### HOW TO ORDER IMPRINTED MARKING TAGS

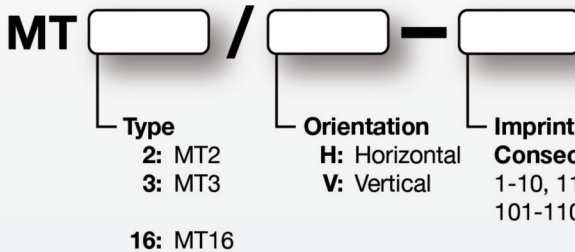

### IMPRINT EXAMPLES FOR MT6

HORIZONTAL				VERTICAL			
Imprint	Cat. No.	Imprint	Cat. No.	Imprint	Cat. No.	Imprint	Cat. No.
1	MT6/H-1	131-140	MT6/H-131-140	1	MT6/V-1	131-140	MT6/V-131-140
2	MT6/H-2	141-150	MT6/H-141-150	2	MT6/V-2	141-150	MT6/V-141-150
3	MT6/H-3	151-160	MT6/H-151-160	3	MT6/V-3	151-160	MT6/V-151-160
4	MT6/H-4	161-170	MT6/H-161-170	4	MT6/V-4	161-170	MT6/V-161-170
5	MT6/H-5	171-180	MT6/H-171-180	5	MT6/V-5	171-180	MT6/V-171-180
6	MT6/H-6	181-190	MT6/H-181-190	6	MT6/V-6	181-190	MT6/V-181-190
7	MT6/H-7	191-200	MT6/H-191-200	7	MT6/V-7	191-200	MT6/V-191-200
8	MT6/H-8	1-100	MT6/H-1-100	8	MT6/V-8	1-100	MT6/V-1-100
9	MT6/H-9	1-50	MT6/H-1-50	9	MT6/V-9	1-50	MT6/V-1-50
10	MT6/H-10	A	MT6/H-A	10	MT6/V-10	A	MT6/V-A
1-10	MT6/H-1-10	B	MT6/H-B	1-10	MT6/V-1-10	B	MT6/V-B
11-20	MT6/H-11-20	C	MT6/H-C	11-20	MT6/V-11-20	C	MT6/V-C
21-30	MT6/H-21-30	L1	MT6/H-L1	21-30	MT6/V-21-30	L1	MT6/V-L1
31-40	MT6/H-31-40	L2	MT6/H-L2	31-40	MT6/V-31-40	L2	MT6/V-L2
41-50	MT6/H-41-50	L3	MT6/H-L3	41-50	MT6/V-41-50	L3	MT6/V-L3
51-60	MT6/H-51-60	N	MT6/H-N	51-60	MT6/V-51-60	N	MT6/V-N
61-70	MT6/H-61-70	R	MT6/H-R	61-70	MT6/V-61-70	R	MT6/V-R
71-80	MT6/H-71-80	S	MT6/H-S	71-80	MT6/V-71-80	S	MT6/V-S
81-90	MT6/H-81-90	X	MT6/H-X	81-90	MT6/V-81-90	X	MT6/V-X
91-100	MT6/H-91-100	Y	MT6/H-Y	91-100	MT6/V-91-100	Y	MT6/V-Y
101-110	MT6/H-101-110	Z	MT6/H-Z	101-110	MT6/V-101-110	Z	MT6/V-Z
111-120	MT6/H-111-120	Ground Symbol	MT6/H-GRND	111-120	MT6/V-111-120	Ground Symbol	MT6/V-GRND
121-130	MT6/H-121-130			121-130	MT6/V-121-130		

# FREE Altech® PLOTTER

with **\$5000**  
in annual  
**Terminal Block**  
purchases

**FREE:**  
**Altech®**  
**CMPS Plotter Package**  
Cat. No. 34130020

**Comes with everything needed  
to begin printing MT5,6,8,10,12  
and 15 tags.**

- CMPS plotter
- Size: 17"x18"x4.9"
- CMPS software with cable
- 1 triple fixture for MT5, 6, 8, 10, 12 & 15
- 2 disposable pens



**Contact your local  
Altech Representative  
for the details.**

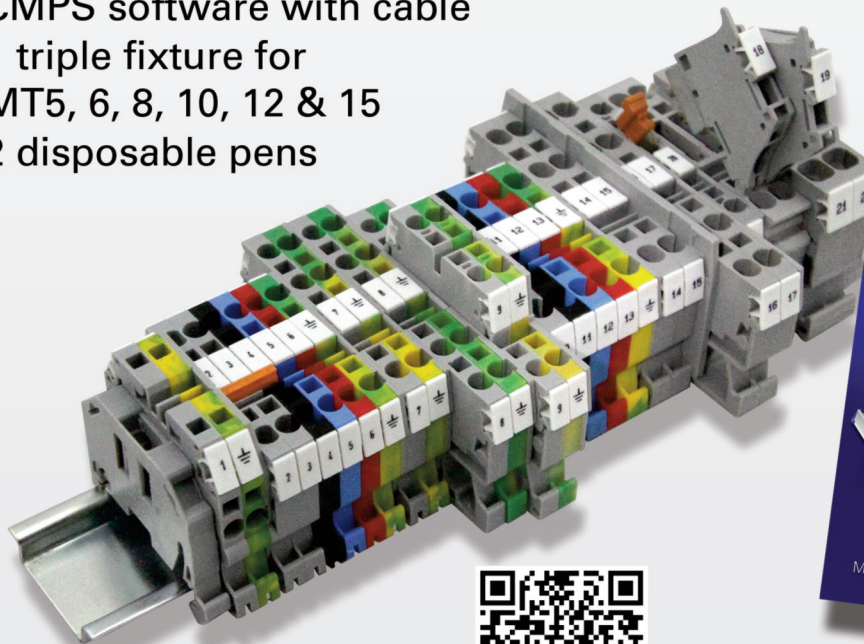

Download a  
Marking System catalog today.

### MARKING SYSTEMS

#### PLOTTERS

The Altech VP Series base unit is an auxiliary plotter that has to be connected to a PC via a USB connection. It is a high speed plotting device and enables plotting of different markers in one setting. The base unit is controlled through a PC with the help of Vario Sign software (sold separately). Manual available in English and Spanish.

The special design of the VP Series enables it to hold different markers from various manufacturers at the same time. It is also possible to write on relatively large markers with a maximum height of 10.5 mm.

#### PLOTTER VP 600 BASIC

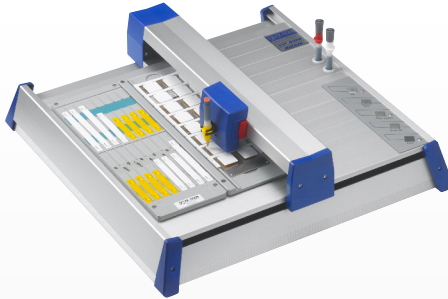

##### Ordering Information

Cat No. 34000082

- Professionally marking of connectors, wires, cables, equipment, cable ties, shrink tubing, labels and signs of different sizes and materials, as well as customer-specific items.
- Manual insertion of plotter pen
- Auto calibration
- Universal Power Supply 100-240V AC
- Control language HPGL
- Universal marking software (VarioSign) sold separately
- Marking area 273 x 305 mm
- Size: 18.5 x 18.9 x 6.1 in. (470 x 480 x 155 mm)
- Weight: 13.9 lbs.

#### PLOTTER VP 600 A3

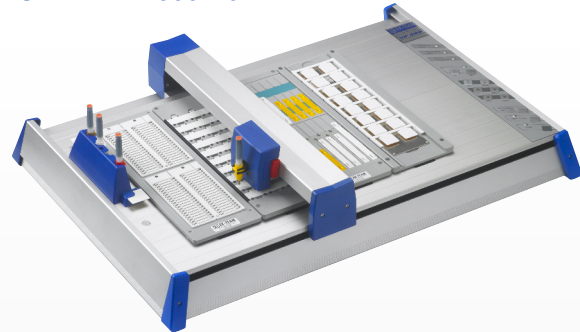

##### Ordering Information

Cat No. 34000080

- Basic features of plotter VP 600 Basic plus:
- Integrated and automated pen station. Holds 4 different pens at the same time, for fast and frequently changing applications.
- Built-in pen priming function
- Automatic recognition system for marking fixture / plates ensures faster and easier handling of frequently changing marking applications.
- Wide marking area 422 x 305 mm
- Size: 27.2 x 18.9 x 6.1 in. (690 x 480 x 155 mm)
- Weight: 18.3 lbs.

### ACCESSORIES

#### PLOTTER PENS



Cat. No.	Description	Tip Size
35003018	Etching Plotter Pen (red)	0.18 mm
35003025	Etching Plotter Pen (white)	0.25 mm
35003035	Etching Plotter Pen (yellow)	0.35 mm
35003118	Non-Etching Plotter Pen (red)	0.18 mm
35003125	Non-Etching Plotter Pen (white)	0.25 mm
35003135	Non-Etching Plotter Pen (yellow)	0.35 mm

#### ALTECH FIXTURES



Cat. No.	Description
34902191	MT2G
34902081	MT2, MT3, MT4, MT2B4
34902001	MT5, MT6, MT8, MT10, MT12, MT16
34902057	MT9
34902080	MTG1, MTG2

\* Fixtures for other Terminal Block Manufacturers are available, please contact Altech for additional information.

#### SOFTWARE



Cat. No.	Description
34000022	Variosign Software