

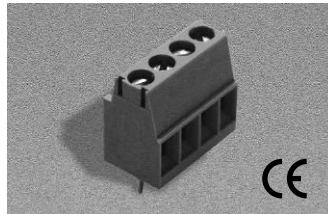

Pin Spacing: 3.81mm  
 Orientation: Vertical  
 Clamp Type: Screw Cage  
 Design: Modular



**MVS-13xx**

**ELECTRICAL**

	Current	Voltage	Wire Range
	10A <sup>②</sup>	300V	30-16 AWG
	12A	130V	1.0mm <sup>2</sup> stranded 1.5mm <sup>2</sup> solid

**INSTALLATION DATA**

Screw Size	M2	PCB Hole Size	1.1mm
Torque	0.25Nm (2.2lbf-in)	Stripping Lgth.	6.7mm

**MATERIAL**

<b>Body</b>	Polyamide	<b>Screw</b>	Galvanized Steel
<b>Flammability Class</b>	UL94V-0	<b>Terminal</b>	Tin-Plated Brass
<b>Temperature Limit</b>	105°C UL 125°C IEC	<b>Clamp</b>	Nickel Brass
<b>Color</b>	Green		

No. Poles	Cat. #	Length (mm)	Std. Pk.
2	MVS-132	7.6	100
3	MVS-133	11.4	100
4	MVS-134	15.2	50
5	MVS-135	19.1	50
6	MVS-136	22.9	50
7	MVS-137	26.7	50
8	MVS-138	30.5	50
9	MVS-139	34.3	50
10	MVS-1310	38.1	50
11	MVS-1311	41.9	50
12	MVS-1312	45.7	50
13	MVS-1313	49.5	20
14	MVS-1314	53.3	20
15	MVS-1315	57.2	20
16	MVS-1316	61.0	20
17	MVS-1317	64.8	20
18	MVS-1318	68.6	20
19	MVS-1319	72.4	20
20	MVS-1320	76.2	20
21	MVS-1321	80.0	20
22	MVS-1322	83.8	20
23	MVS-1323	87.6	20
24	MVS-1324	91.4	20

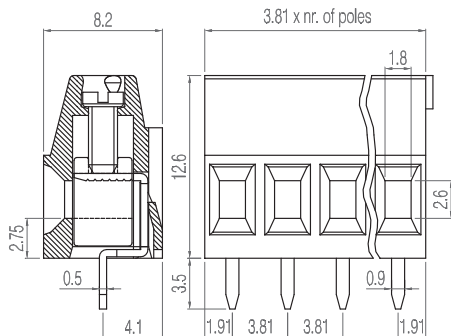

Pin Spacing: 5.00mm  
 Orientation: Horizontal  
 Clamp Type: Tubular Screw with Wire Protector  
 Design: Modular

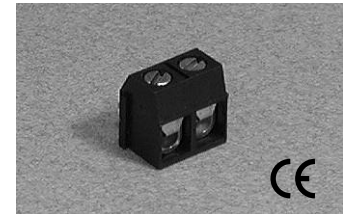

**MHE-13xx**

**ELECTRICAL**

	Current	Voltage	Wire Range
	16A	250V	22-16AWG

**INSTALLATION DATA**

Screw Size	M2.6	PCB Hole Size	1.3mm
Torque	0.4Nm (3.6 lbf-in.)	Stripping Lgth.	5.6mm

**MATERIAL**

<b>Body</b>	Glass-Filled Polyester	<b>Screw</b>	Galvanized Steel
<b>Flammability Class</b>	UL94V-0	<b>Terminal</b>	Tin-Plated Brass
<b>Temperature Limit</b>	130°C UL 125°C IEC	<b>Wire Protector</b>	CuSn6
<b>Color</b>	Black		

No. Poles	Cat. #	Length (mm)	Std. Pk.
2	MHE-132	10.0	100
3	MHE-133	15.0	100
4	MHE-134	20.0	50
5	MHE-135	25.0	50
6	MHE-136	30.0	50
7	MHE-137	35.0	50
8	MHE-138	40.0	50
9	MHE-139	45.0	50
10	MHE-1310	50.0	50
11	MHE-1311	55.0	50
12	MHE-1312	60.0	50
13	MHE-1313	65.0	20
14	MHE-1314	70.0	20
15	MHE-1315	75.0	20
16	MHE-1316	80.0	20
17	MHE-1317	85.0	20
18	MHE-1318	90.0	20
19	MHE-1319	95.0	20
20	MHE-1320	100.0	20
21	MHE-1321	105.0	20
22	MHE-1322	110.0	20
23	MHE-1323	115.0	20
24	MHE-1324	120.0	20

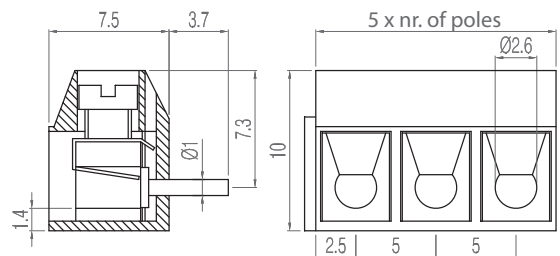

② 12A Factory Wiring - UL