

### Mini Screw Clamp Design

For applications with space restraints, Altech offers a mini panel mount and mini 15mm DIN Rail Mount solution. In order to provide a vibration resistant wire termination, both styles come equipped with the most reliable rising cage clamp design where both the clamping yoke and current bar are serrated to maximize gripping force.

- CMB4 Panel mount Series, are modular blocks that snap together to form an assembly. The End Plates have counter bored mounting holes which allow you to use M3 screws to mount the assembly directly to your panel.
- CMT4 DIN Rail Mountable Series snap onto our compact 15mm DIN Rail (Part # CA601/S). CGMT4 grounding blocks are available as well as our new CF4U and CF4U(L) fuse blocks, which are also 15mm DIN rail mountable.

### Mini Spring Clamp Design

If a mini screwless panel mount assembly is required we can offer our CSCP2.5 series. Like our CMB4 Series, the CSCP2.5 series are modular blocks that snap together to form an assembly. For mounting purposes, the End Plates are equipped with mounting ears which allows you to mount the assembly directly to your panel.

### Busbar (Neutral/Earth Clamps)

Our CENC series with (10x3mm) or (6x6mm) Busbar, is a flexible solution for terminating neutral and grounding wires to a busbar. This assembly can be panel mounted by using our NES busbar mounting blocks or can be DIN rail mountable by utilizing our CA202 End Stops.

### High Temperature Ceramic EuroBlocks

Our CB Series ceramic terminal blocks are offered with or without mounting holes for either panel mount or free floating applications. These blocks are designed to withstand extremely high temperatures (-40° to 600°C)

# MINI RAIL & PANEL MOUNT

## TERMINAL BLOCKS

For use when space constraints require extremely compact solutions and internal jumping is required.

Individual components can be used to build your own assemblies. Just snap the required number of terminal block components together and place a Mounting Section on each end.

The CMB4 accepts internal jumpers and standard marking tags.

- Extremely compact and cost effective
- High density
- Screw-cage clamp
- Internal jumping provision
- Polyamide 6.6
- Standard color: gray

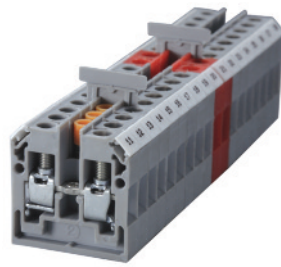

**CMB4**

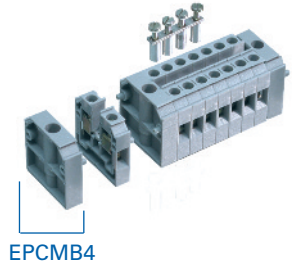

Terminal Width	6 mm		
Height x Length	28 x 27 mm		
Stripping Length	9 mm		
Insulation Material	Polyamide 6.6		
Type of Connection	2 screw clamps & 1 tapped hole for cross connect.		
Approvals			
Wire Range	22-10 AWG	0.2-4 sq.mm	22-10 AWG
Voltage Rating	300 V	500 V	300 V
Current Rating	35 A	32 A	30 A
Torque	7 lb-in	0.5 Nm	7 lb-in

Other Approvals



**Terminal Block**

Mounting Section

Separator Plate

Mounting Screw\*

Internal Jumper**		2 pole	CA727/2	100
		3 pole	CA727/3	100
		4 pole	CA727/4	100
		10 pole	CA727/10	10

Insulated Internal Jumper**		2 pole	CA747/2	100
		3 pole	CA747/3	100
		4 pole	CA747/4	100
		10 pole	CA747/10	10

Current Bars		2 pole	CA703/1	100
		3 pole	CA704/1	100
		4 pole	CA705/1	100
		10 pole	CA732/10	100
		10 pole (breakable)	CA732/10-A	100
		100 pole	CA732/100	10

Shorting Sleeve & Screw**		CA607/S/Q	100
---------------------------	--	-----------	-----

External Jumper		2 pole	CA714/2	100
		3 pole	CA714/3	100
		4 pole	CA714/4	100
		10 pole	CA714/10	20

Marking Tags		MT2	100
--------------	--	-----	-----

Preassembled blocks are also available for quick and easy installations. See Dimensions below.

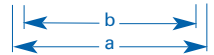

Dimensions mm (in.)  
CMB4

Cat No.	No. of Poles	Width (a)	Hole Spacing (b)
CMB4/2	2	26 (1.02)	19 (0.75)
CMB4/3	3	32 (1.26)	25 (0.98)
CMB4/4	4	38 (1.50)	31 (1.22)
CMB4/5	5	44 (1.73)	37 (1.46)
CMB4/6	6	50 (1.97)	43 (1.69)
CMB4/7	7	56 (2.20)	49 (1.93)
CMB4/8	8	62 (2.44)	55 (2.17)
CMB4/9	9	68 (2.68)	61 (2.40)
CMB4/10	10	74 (2.91)	67 (2.64)
CMB4/11	11	80 (3.15)	73 (2.87)
CMB4/12	12	86 (3.39)	79 (3.11)
CMB4/13	13	92 (3.62)	85 (3.35)
CMB4/14	14	98 (3.86)	91 (3.58)
CMB4/15	15	104 (4.09)	97 (3.82)
CMB4/16	16	110 (4.33)	103 (4.06)
CMB4/17	17	116 (4.57)	109 (4.29)
CMB4/18	18	122 (4.80)	115 (4.53)
CMB4/19	19	128 (5.04)	121 (4.76)
CMB4/20	20	134 (5.28)	127 (5.00)
CMB4/21	21	140 (5.51)	133 (5.24)
CMB4/22	22	146 (5.75)	139 (5.47)
CMB4/23	23	152 (5.98)	145 (5.71)
CMB4/24	24	158 (6.22)	151 (5.94)

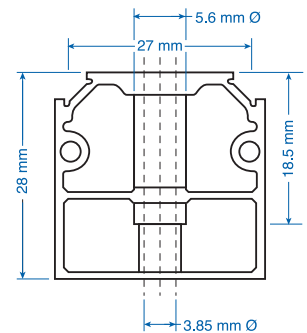

Mounting Section  
EPCMB4

\* Any length M3 screw may be used.  
\*\* Torque recommendation is 3.5 lb-in.

**COLOR BLOCKS**  
(other than standard grey)

When ordering please add color suffix to Cat. No.

Example for color Red: **Cat.No./R**

Color	Ordering Suffix	
Red	R	
Yellow	Y	
Blue	BU	
Green	G	
Orange	O	
Beige	BG	
Dark Brown	DB	
Black	BL	
White	W	

Consult Altech for availability:

# Mini Feed-Through 15mm

For wire-to-wire connecting in control, automation, instrumentation and power distribution applications.

Altech "miniature" terminal blocks offer tremendous space advantage as demanded by certain wiring configurations.

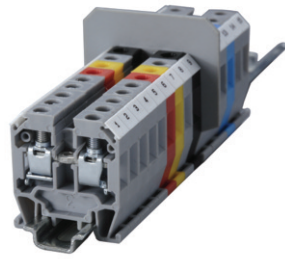

## CMT4

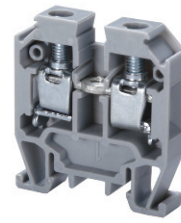

## CGMT4



Terminal Width	6 mm			6 mm		
Height x Length	29 x 27 mm			28.5 x 27 mm		
Stripping Length	9 mm			9 mm		
Insulation Material	Polyamide 6.6			Polyamide 6.6		
Type of Connection	2 screw clamps & 1 tapped hole for cross connection			2 screw clamps		
Approvals						
Wire Range	22-10 AWG	0.2-4 sq.mm	22-10 AWG	22-10 AWG	0.2-4 sq.mm	22-10 AWG
Voltage Rating	300 V	500 V	300 V		400 V	
Current Rating	35 A	32 A	35 A		32 A	
Torque	7 lb-in	0.5 Nm	7 lb-in	7 lb-in	0.5 Nm	7 lb-in

Other Approvals AEx eII Ex eII U

Cat. No.	Std. Pk.	Cat. No.	Std. Pk.
----------	----------	----------	----------

Terminal Block		CMT4	100	CGMT4	50
End Plate		EPCMT4	50		
Isolation Partition		PPCMT4	50		
DIN Rail	for ordering information refer to pages 90-91				
End Stop	for ordering information refer to page 92	CA602	100		
Internal Jumper	2 pole 3 pole 4 pole 10 pole	CA727/2 CA727/3 CA727/4 CA727/10	100 100 100 10		
Insulated Internal Jumper	2 pole 3 pole 4 pole 10 pole	CA747/2 CA747/3 CA747/4 CA747/10	100 100 100 10		
Current Bars	2 pole 3 pole 4 pole 10 pole 10 pole (breakable) 100 pole	CA703/1 CA704/1 CA705/1 CA732/10 CA732/10-A CA732/100	100 100 100 100 100 10		
Shorting Sleeve & Screw		CA607/S/Q	100		
External Jumper	2 pole 3 pole 4 pole 10 pole	CA714/2 CA714/3 CA714/4 CA714/10	100 100 100 20		
Marking Tags		MT2	100	MT2	100

**COLOR BLOCKS**  
(other than standard grey)

When ordering please add color suffix to Cat. No.  
Example for color Red: **Cat.No./R**

Color	Ordering Suffix
Red	R
Yellow	Y
Blue	BU
Green	G
Orange	O
Beige	BG
Dark Brown	DB
Black	BL
White	W

Consult Altech for availability.

Certain electrical and control systems require protection by fuses. The terminal has a hinged carrier that has a specially designed space for a cartridge type glass fuse of size Ø5 x 20 or Ø5 x 25 mm. The fuse can be engaged or disengaged by the movement of the carrier.

Altech fuse terminals are also available with light indication - CF4U(L). A specially designed built-in circuit gives light indication in the event of fuse blow out. No polarity is required.

† Fuses are sold separately Altech, see pages 100-101

\* Add required voltage to part number as a suffix. i.e. CF4U(L)/6-60 for 6-60 V AC/DC.



**CF4U†**

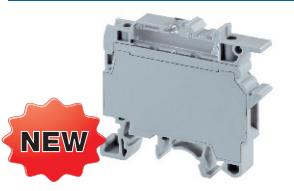

**CF4U(L)†\***



**No Polarity Required.**

Terminal Width	8 mm
Height x Length	57.6 x 57 mm
Stripping Length	9.5 mm
Insulation Material	Polyamide 6.6
Type of Connection	4 screw clamps
LED Voltage	6-60 V AC/DC 90-240 V AC/DC
Type of Fuse Used	Ø5x20, Ø5x25 mm
Approvals	
Wire Range	
Voltage Rating	
Current Rating	
Torque	
Other Approvals	





Terminal Width	8 mm
Height x Length	57.6 x 57 mm
Stripping Length	9.5 mm
Insulation Material	Polyamide 6.6
Type of Connection	4 screw clamps
LED Voltage	CF4U(L)/6-60 CF4U(L)/90-240
Type of Fuse Used	Ø5x20, Ø5x25 mm
Approvals	
Wire Range	
Voltage Rating	
Current Rating	
Torque	
Other Approvals	



Terminal Width	8 mm
Height x Length	57.6 x 57 mm
Stripping Length	9.5 mm
Insulation Material	Polyamide 6.6
Type of Connection	4 screw clamps
LED Voltage	CF4U(L)/6-60 CF4U(L)/90-240
Type of Fuse Used	Ø5x20, Ø5x25 mm
Approvals	
Wire Range	
Voltage Rating	
Current Rating	
Torque	
Other Approvals	





**Terminal Block**

DIN Rail for ordering information refer to pages 90-91





End Stop for ordering information refer to page 92 



Internal Jumper	2 pole	
	3 pole	
	4 pole	
	10 pole	

Insulated Internal Jumper	2 pole	
	3 pole	
	4 pole	
	10 pole	

Current Bar	2 pole	
	3 pole	
	4 pole	
	10 pole	

Shorting Sleeve & Screw 

External Jumper	2 pole	
	3 pole	
	4 pole	
	10 pole	

Marking Tags (on terminal)   
(on Lever) 

Cat. No.	Std. Pk.
----------	----------

<b>CF4U</b>	100
	
CA702	50
CA802	50

Cat. No.	Std. Pk.
----------	----------

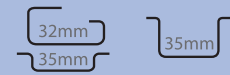
<b>CF4U(L)*</b>	50
	
CA702	50
CA802	50

**CF4U(L) Only**

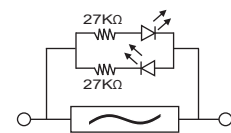

LED Circuit for offline indication in CF4U(L)/6-60V

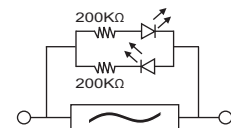

LED Circuit for offline indication in CF4U(L)/90-240V

CA711/2	100
CA711/3	50
CA711/4	50
CA711/10	20









CA711/2	100
CA711/3	50
CA711/4	50
CA711/10	20

MT8	100
MT8	100

MT8	100
MT8	100

**COLOR BLOCKS**  
(other than standard grey)

When ordering please add color suffix to Cat. No.  
Example for color Red: **Cat.No./R**

Color	Ordering Suffix	
Red	R	
Yellow	Y	
Blue	BU	
Green	G	
Orange	O	
Beige	BG	
Dark Brown	DB	
Black	BL	
White	W	

Consult Altech for availability.

# Spring Clamp Panel Mount

Altech "screwless" spring clamp panel mount terminal blocks are an excellent solution for extremely compact wiring applications.

These terminal blocks are "add-on" type and can be combined to form multipole assemblies. The stacked assembly is fitted with mounting end sections on both ends for easy installation on to the panel.

The terminal has marker holding recesses on three sides to accept marking tags. Cross connection can be achieved with the aid of insulated jumpers.

The CSCP2.5T2 panel mount terminal blocks have two connection points on each side all with the same potential. The terminals provide possibility of further multiplication through jumpering.



COLOR BLOCKS (other than standard grey)		
<b>When ordering please add color suffix to Cat. No.</b>		
Example for color Red: <b>Cat.No./R</b>		
Color	Ordering Suffix	
Red	R	
Yellow	Y	
Blue	BU	
Green	G	
Consult Altech for availability:		
Orange	O	
Beige	BG	
Dark Brown	DB	
Black	BL	
White	W	

	CSCP2.5T			CSCP2.5T2		
Terminal Width	5 mm			10 mm		
Height x Length	27 x 35 mm			27 x 35 mm		
Stripping Length	11 mm			11 mm		
Insulation Material	Polyamide 6.6			Polyamide 6.6		
Type of Connection	2 spring clamp connections			4 spring clamp connections		
Approvals						
Wire Range	22-14 AWG	0.2-2.5 sq.mm	22-14 AWG	22-14 AWG	0.2-2.5 sq.mm	22-14 AWG
Voltage Rating	600 V	800 V	600 V	600 V	800 V	600 V
Current Rating	20 A	24 A	20 A	20 A	24 A	20 A
Other Approvals						

	Cat. No.	Std. Pk.	Cat. No.	Std. Pk.
<b>Terminal Block</b>	<b>CSCP2.5T</b>	100	<b>CSCP2.5T2</b>	100
End Section (set of left and right)	EPCSCP2.5T	25	EPCSCP2.5T	25
Insulated Jumper (2 pole)	CA803/1	100	CA803/1	100
Marking Tags	MT4	100	MT3	100
Operating Tool	SCA2-5	1	SCA2-5	1

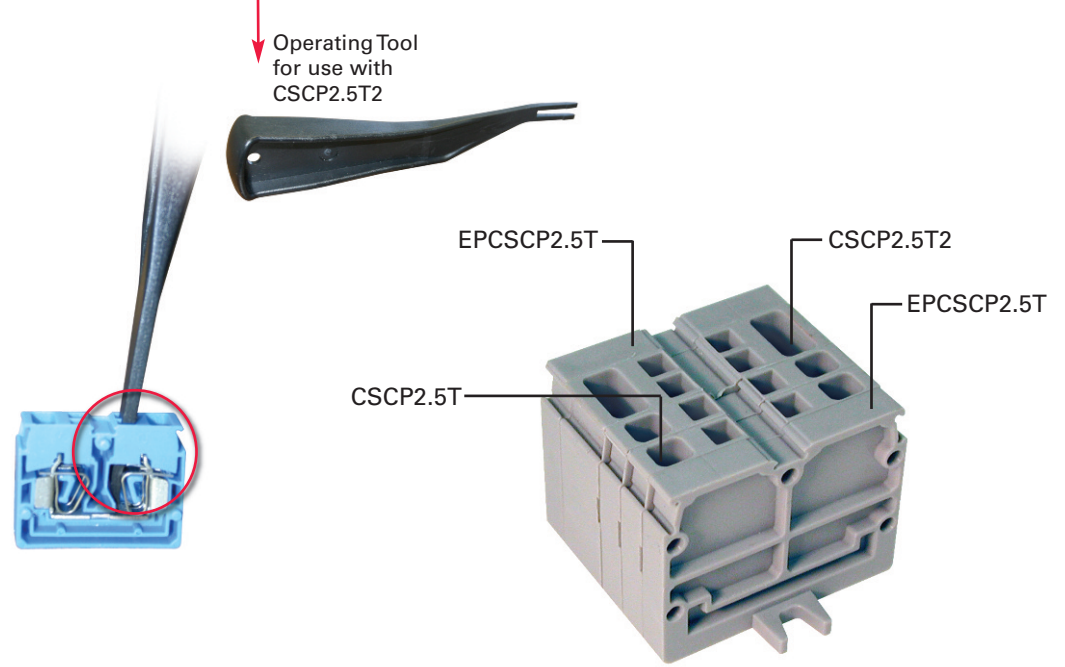

A quick reliable solution for ground, neutral or low voltage distribution applications. The Busbar System consists of a busbar, busbar supports, and screw clamp terminals for terminating wires.

NEB 10 (10 x 3 mm) and NEB 6 (6 x 6 mm), tin plated copper busbars are available in one meter lengths. Both have a 140A current carrying capacity.

NES plastic support with fixing screws for holding 10 x 3 & 6 x 6 busbar makes placing of busbar an easy task. Busbars up to 200 mm length should be supported at ends by two busbar supports. For busbars exceeding 200 mm length, it is recommended to provide intermediate busbar support. Easy to operate CENC clamp secures wire to the busbar.

	CENC4		CENC16		CENC35				
									
Terminal Width	7.5 mm		9.8 mm		14.5 mm				
Height x Length	30 x 23.3 mm		36 x 23.3 mm		45 x 27.3 mm				
Stripping Length	12 mm		16 mm		16 mm				
Insulation Material	Polyamide 6.6		Polyamide 6.6		Polyamide 6.6				
Type of Connection	1 screw clamp connection		1 screw clamp connection		1 screw clamp connection				
Approvals	  		  		  				
Wire Range	22-10 AWG	0.2-6 sq.mm	22-12 AWG	10-4 AWG	6-16 sq.mm	10-6 AWG	8-2 AWG	10-35 sq.mm	8-2 AWG
Current Rating*		41 A			76 A			125 A	
Torque	14 lb-in	0.8 Nm	14 lb-in	14 lb-in	2.0 Nm	17.5 lb-in	25 lb-in	2.5 Nm	25 lb-in
Other Approvals	 		 		 				
	<b>Cat. No.</b>	<b>Std. Pk.</b>	<b>Cat. No.</b>	<b>Std. Pk.</b>	<b>Cat. No.</b>	<b>Std. Pk.</b>			
<b>Terminal Block**</b>	<b>CENC4</b>	50	<b>CENC16</b>	50	<b>CENC35</b>	50			
Busbar (10 x 3 mm) 	NEB10	1 m	NEB10	1 m	NEB10	1 m			
Busbar (6 x 6 mm) 	NEB6	1 m	NEB6	1 m	NEB6	1 m			
Plastic Support with Fixing Screw 	NES	50	NES	50	NES	50			
End Clamp/Bus bar support for rail mounting	CA202	50	CA202	50	CA202	50			
Marking Tags 	MT5	100	MT6	100	MT6	100			

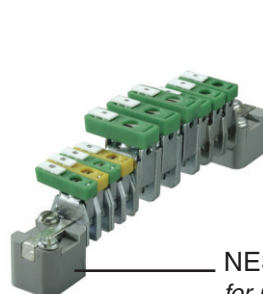

NES  
for panel mount  
applications

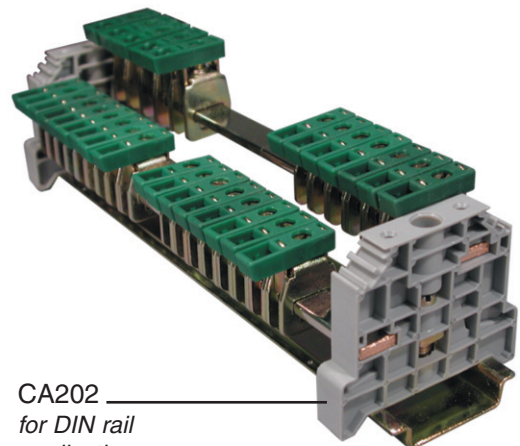

CA202  
for DIN rail  
applications

\* 140A current carrying capacity of busbar should be taken into account while connecting loads.  
\*\* Consult for other available colors.

# High Temperature Ceramic EuroBlocks™

Suitable for use in high temperature applications up to 600°C (1112°F). Applications include hot melt glue guns, furnaces, heaters, process equipment and machinery. Terminal blocks are offered with mounting holes for panel mounting or free floating applications.

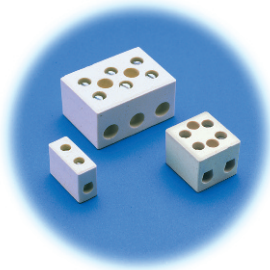

- Compact, space saving
- Tubular screw clamp
- Free float or panel mount
- Temperature range: -40°C (-40°F) to 600°C (1112°F)
- Standard color: white
- Material  
Housing: Steatite  
Clamp: Brass  
Screws: Zinc plated steel



Insulation Material	Ceramic			Ceramic			Ceramic		
Approvals									
Wire Range	24-12 AWG .5-2.5mm <sup>2</sup> 24-12 AWG			22-10 AWG .5-4mm <sup>2</sup> 22-10 AWG			20-6 AWG .5-2.5mm <sup>2</sup> 18-6 AWG		
Voltage Rating	300V	800 V	300V	300V	800 V	300V	300V	800 V	300V
Current Rating	30 A	24 A	20 A	40 A	32 A	30 A	76 A	57 A	65 A
Torque	6 lb-in. 0.4 Nm 6 lb-in.			6 lb-in. 0.5 Nm 6 lb-in.			12 lb-in. 1.2 Nm 12 lb-in.		

No. of Poles	Cat. No.	Std. Pk.	Cat. No.	Std. Pk.	Cat. No.	Std. Pk.
1 (free floating)	CB4/1	50	CB6/1	50		
2 (free floating)	CB4/2	50				
2 (with mounting holes)	CB4/2H	50	CB6/2H	50	CB16/2H	50
3 (free floating)	CB4/3	50				
3 (with mounting holes)	CB4/3H	50	CB6/3H	50	CB16/3H	50
4 (with mounting hole)	-	-	CB6/4H*	50	-	-

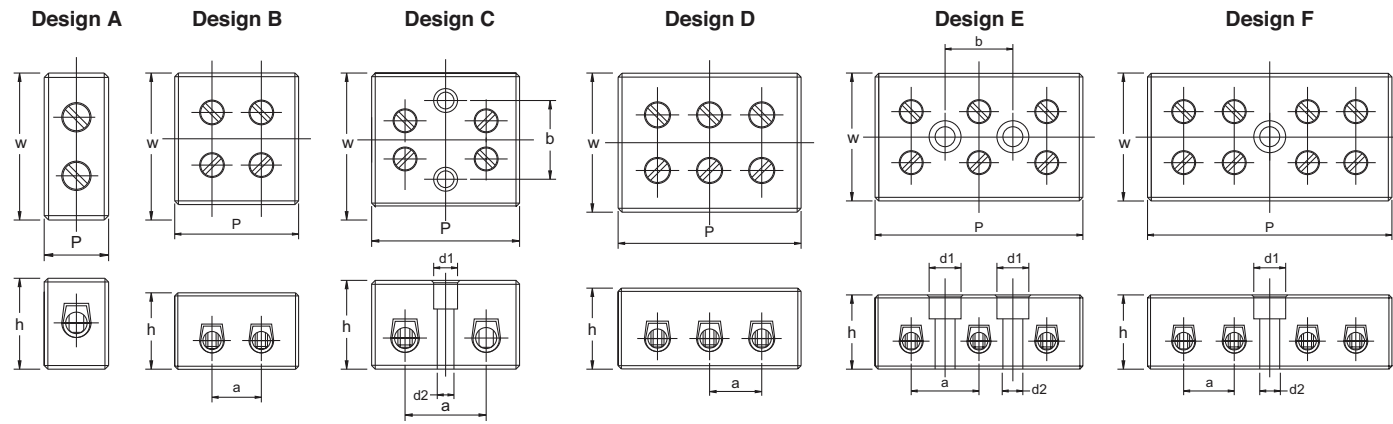

Type Cat. No.	Design Type	No. of Poles	Stripping Length	P	a	b	w	h	d1	d2	Recommended Mounting Screw
CB4/1	A	1	6	11	-	-	23	18.5	-	-	-
CB4/2	B	2	6	18	7.3	-	23	18.5	-	-	-
CB4/2H	C	2	6	24	13	14.6	23	18.5	6	3.5	M3 x 16
CB4/3	D	3	6	25	7.3	-	23	18.5	-	-	-
CB4/3H	E	3	6	36	13	13	23	18.5	6	3.5	M3 x 16
CB6/1	A	1	6	12	-	-	25.5	19.5	-	-	-
CB6/2H	C	2	6	26	15	12.6	25.5	19.5	6	3.5	M3 x 16
CB6/3H	E	3	6	41	15	15	25.5	19.5	6	3.5	M3 x 16
CB16/2H	C	2	8.5	31	17	16.5	28	23.2	6	3.5	M3 x 20
CB16/3H	E	3	8.5	48	17	17	28	23.2	6	3.5	M3 x 20
CB6/4H	F	4	6	39	8	-	20	16	6	3.5	M3 x 16

\*UL Recognition in progress for CB6/4H

Note: All dimensions are shown in mm, to convert to inches please divide by 25.4.