

Amphenol

Amphenol-Tuchel Electronics GmbH

M12 - Connectors C 112 Series



We connect com

The company

Amphenol-Tuchel Electronics is a worldwide leader in electrical connectors and contacting devices.

Our line of high quality, peak performance products are achieved through the implementation of modern manufacturing methods utilizing the latest technologies. Local markets are served through an extensive global network of distributors and manufacturing sites. Amphenol sets the standard of connector technology with an array of patent and innovations.

Our vast experience in aerospace, automotive, data transfer, military, and telecommunications enables us to provide solutions to your market challenges.



System Description

Amphenol's M12 family of connectors features the C112 series. They are characterized by compact size, functional design, reliable sealing, durable construction and electrically stable.

The connector protects the cable and its components from loosening due to harsh vibration while operating in tough industrial environments. Electrically sensitive applications requiring EMI shielding are protected with a design that enables attenuation values in the range of a double shielded cable. This design feature incorporates a 360° shielding system from the cable to the appliance housing.

The connectors in the C112 family use a 12 mm thread. These connectors are top choice in automation and sensor technology. Power circuit requirements up to four amps can also be satisfied by this connector design.

Continents



Standards

Connectors meet these standards:
IEC 61076-2-101, interfaces according
to (IEC 60947-5-2) and proximity switches
(VDE 0660 part 208).



EMI

German EMI regulations (EMI-guideline:
89/336 EWG) are met when correctly
assembled in the appliance.

Application and use

Connectors should be used according to their rated performance values. These rated values are established under specific conditions to meet product specifications or other electrical qualifications. The C112 connectors are designed for use in a variety of electrical equipment and applications that control various appliances or link communications with sensor technology.

The user is responsible to verify that the connector meets the application requirements of the product. All connector rating data in this catalog is based on the overvoltage of category III and pollution degree of 2/3 for electrical devices. All specifications are met when the connectors are completely mated.

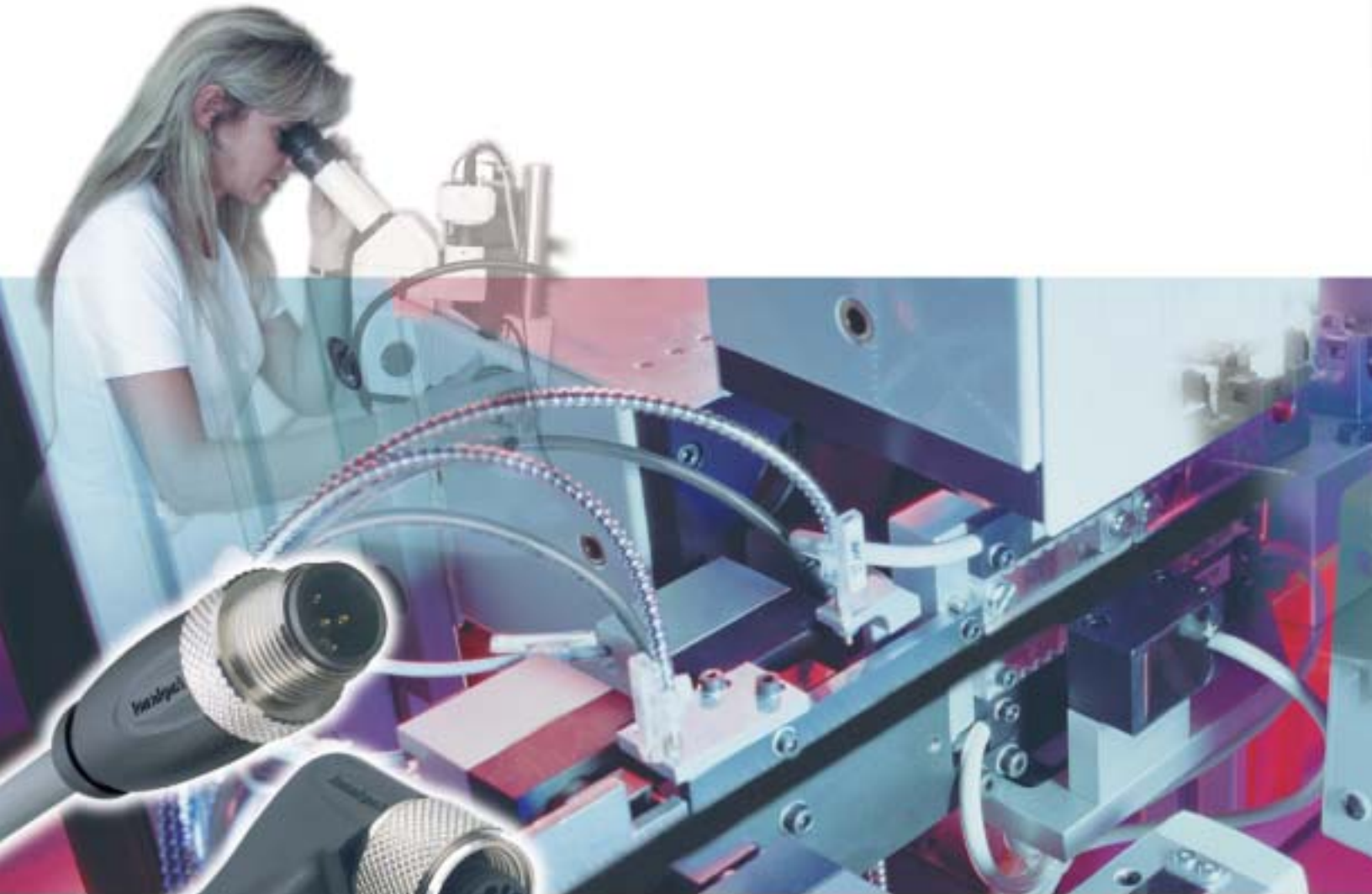

Assembly

The housings of the panel receptacle or plug must be reliably integrated into the protective means of the enclosure. Reference: DIN VDE 0100 part 410; 80384-4-41. During assembly,

care must be given to ensure that all components are correctly mounted and screw terminations are tightened to the correct torque.

Termination

Customer assembled cable connectors must follow precise instructions to properly secure the strain relief system. There is an integrated strain relief clamp or a standard Pg cable entry. The standard Pg cable entry requires a strain relief close to the rear of the connector. Cable selection should

meet the same specifications as the connector (i.e., solvent resistance or fire protection). Correct polarity must be observed when terminating wires. The wire insulation should be stripped to the proper length and wire diameter.

Remarks

The C112 connectors are designed and produced in conformance with the low voltage guidelines: 72/73 EWG and the law for safety of appliances. The connectors are designed and manufactured according to DIN VDE 57-0627. Design changes to meet quality improvements, product development or production requirements are reserved. All technical data is related to connectors operating under normal use and loads when fully mated. Connectors should not be mated or unmated while under load. Connector safety is dependent

upon the correct selection of products, installation, and assembly. The listed technical data and remarks are intended to help the user select the correct products for the appropriate applications.

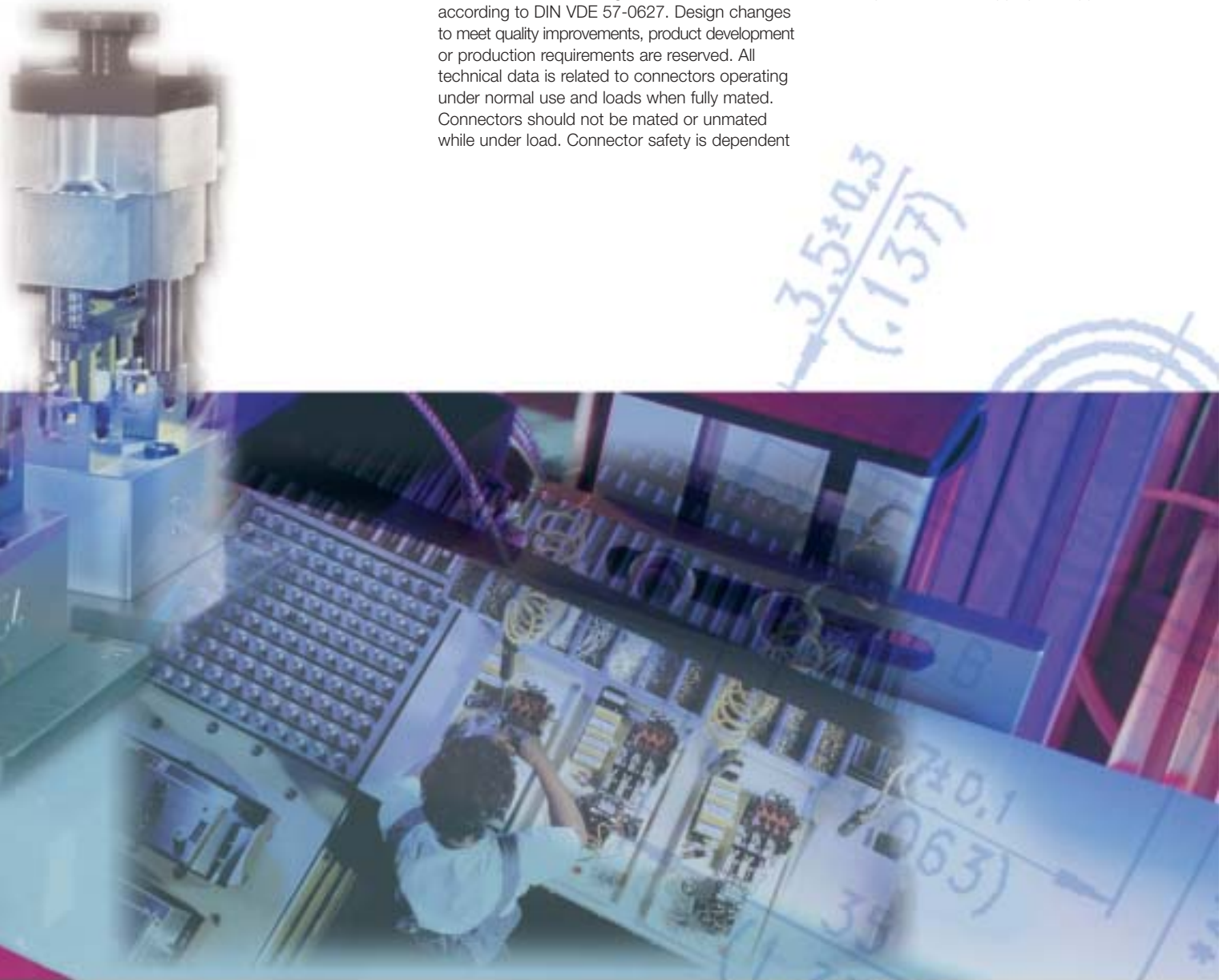

Safety classification according to DIN VDE 0627

Type	Feature	Safety classification ¹⁾ A B C	Connector		Protective earth contact		Protection against ¹⁾		Rewireable	
			free	fixed	with	without	D	E	yes	no
male cable con.		X	X		X	X				X
female cable connector	with LED, customer ass'y	X	X		X	X	X	X	X	
female cable con.		X	X		X	X	X			X
Cordset		X	X		X	X	X			X
Female panel con.		X	X		X	X	X			X
Male panel con.		X	X		X	X				X
Male panel con.	customer ass'y	X	X		X	X			X	
Distributors		X	X		X	X	X			X

¹⁾ A Connections to and from a device / B Connections within a device / C Free cable connection
D Mated / E Unmated

Content

	<p>Male cable connectors / Female cable connectors, overmolded</p> <p>Male cable connector, straight Page 10 Male cable connector, right angled Page 10 Female cable connector, straight Page 11 Female cable connector, right angled Page 11 Male cable connector, straight, shielded Page 12 Male cable connector, right angled, shielded Page 12 Female cable connector, straight, shielded Page 13 Female cable connector, right angled, shielded Page 13 Female cable connector, right angled, customer assembly Page 14</p>
	<p>Male cable connectors / Female cable connectors, customer assembly</p> <p>Male cable connector, straight and right angled Page 16 Female cable connector, straight and right angled Page 16 Male cable connector, straight, shielded Page 17 Female cable connector, straight, shielded Page 17 Female cable connector, shielded Page 17</p>
	<p>Cordsets, overmolded</p> <p>Male connector, straight / Female connector, straight Page 22 Male connector, straight / Female connector, right angled Page 22</p> <p>Cordsets, shielded, overmolded</p> <p>Male connector, straight / Female connector, straight Page 23 Male connector, straight / Female connector, right angled Page 23</p>
	<p>Male and female panel connectors</p> <p>Male panel connector, front mounting Page 27 Female panel connector, front mounting Page 27 Male panel connector, rear mounting Page 28 Female panel connector, rear mounting Page 28 Male panel connector, rear mounting, pcb-mount type Page 29 Female panel connector, rear mounting, pcb-mount type Page 29 Male panel connector, installation version Page 29</p>
	<p>Distributors</p> <p>Y-Distributor Page 33 Distribution box Page 34</p>

Male/Female Cable Connectors overmolded

C112 series



Male cable connector, straight, unshielded
anti-vibration coupling nut and overmolded cable ... Page 10

Male cable connector, straight, shielded
anti-vibration coupling nut and overmolded cable ... Page 12



Male cable connector, right angled, unshielded
anti-vibration coupling nut and overmolded cable ... Page 10

Male cable connector, right angled, shielded
anti-vibration coupling nut and overmolded cable ... Page 12



Female cable connector, straight, unshielded
anti-vibration coupling nut and overmolded cable ... Page 11

Female cable connector, straight, shielded
anti-vibration coupling nut and overmolded cable ... Page 13



Female cable connector, right angled, unshielded
anti-vibration coupling nut and overmolded cable ... Page 11

Female cable connector, right angled, shielded
anti-vibration coupling nut and overmolded cable ... Page 13

Description

M12 cables available with male or female connectors, straight or angled housings and cable jacket materials in PVC or PUR.

EMI shielded M12 cables are available with male and female connectors, straight or angled housings and cable jacket materials in PVC or PUR.



General characteristics	Standard	Standard Version	Shielded	Customer Assembly
Number of contacts		3 / 4 / 5 ³⁾	3 / 4 / 5 ³⁾	3 / 3+PE

Electrical characteristics

Contact resistance	IEC 60 512-2, test 2 a	≤ 10 mΩ (without cable)		≤ 10 mΩ
Current carrying capacity	IEC 60 512-3, test 5 b	4 A at T _U = 40°C		without LED 7 A at T _U = 40°C with LED 3,5 A at T _U = 40°C
Rated voltage	IEC 60 664-1 ²⁾	3+4 cont. 250 V AC/DC	60 V AC/DC	without LED 250 V AC/DC
	IEC 60 664-1 ²⁾	5 cont. 60 V AC/DC	60 V AC/DC	with LED 36 V DC
Rated impulse voltage	IEC 60 664-1 ²⁾	3+4 cont. 2,5 kV	0,8 kV	without LED 2,5 kV
	IEC 60 664-1 ²⁾	5 cont. 1,5 kV	0,8 kV	–
Insulation resistance	IEC 60 512-2, test 3 a	> 10 ⁸ Ω		> 10 ⁸ Ω
Pollution degree	IEC 60 664-1 ²⁾	3 ¹⁾		3
Material group	IEC 60 664-1 ²⁾	I		II
Test voltage	IEC 60 664-1 ²⁾	3 + 4 cont. 1,4 kV AC 5 cont. 1,0 kV AC	0,5 kV AC	–

Climatic characteristics

Climatic category	IEC 60 068-1	25 / 85 / 21	without LED: 30 / 100 / 56
			with LED: 30 / 80 / 56
Temperature range	IEC 60 512-6, test 11 i+j	–25°C - +85°C –13°F - +185°F	without LED: –30°C - +100°C –22°F - +212°F
			with LED: –30°C - +80°C –22°F - +176°F

Materials

Contact insert		TPU	PA
Contact plating		Au	Ag
Overmolding		TPU	PA
Housing		–	PA
Knurled screw / knurled nut		CuZn nickel plated	PA
O-Ring		Viton	NBR

Mechanical characteristics

Protection class	IEC 60 529	IP 65 and IP 67 when properly mated	IP 65 when properly mated
Mechanical operation	IEC 60 512-5, Test 9 a	≥ 100 mating cycles	≥ 50 mating cycles
Insertion force	IEC 60 512-7, Test 13 b	≤ 25 N	≤ 25 N
Withdrawal force	IEC 60 512-7, Test 13 b	≤ 30 N	≤ 30 N

Other technical characteristics

Type of termination		crimp (overmolded)	screw clamps
Wire size		0,34 mm ² (AWG 22)	0,14 - 0,5 mm ² (AWG 24-20)
Flammability		UL 94 HB	UL 94 V-0
Locking		Screw coupling	Screw coupling

¹⁾ In mated position only

²⁾ IEC 60664-1 corresponds to DIN VDE 0110

³⁾ Contact no. 5 is "first mate – last break" and can be used for grounding purpose. When grounding the customer must mark the wire.

Furthermore the user has to ensure that this connector is not mated with such connectors where contact no 5 is under voltage

Cable construction PVC

- Partly oil and chemical proof
- Especially suited for dry areas

	Color code	Conductors	Cable jacket	
			Ø mm	material
Cable 01	Brown, blue, black	3 x 0,34 mm ² (AWG 22)	5	PVC
Cable 02	Brown, white, blue, black	4 x 0,34 mm ² (AWG 22)	5	PVC
Cable 03	Brown, white, blue, black, grey	5 x 0,34 mm ² (AWG 22)	5	PVC
Cable 07	Brown, blue, black	3 x 0,34 mm ² (AWG 22)	5	PVC shielded
Cable 08	Brown, white, blue, black	4 x 0,34 mm ² (AWG 22)	5	PVC shielded
Cable 09	Brown, white, blue, black, grey	5 x 0,34 mm ² (AWG 22)	5	PVC shielded

Cable construction PUR

- Very good oil and chemical resistance
- Especially suited for applications in the machine and installation area with rough environments, also in the food industry

	Color code	Conductors	Cable jacket	
			Ø mm	material
Cable 04	Brown, blue, black	3 x 0,34 mm ² (AWG 22)	5	PUR
Cable 05	Brown, white, blue, black	4 x 0,34 mm ² (AWG 22)	5	PUR
Cable 06	Brown, white, blue, black, grey	5 x 0,34 mm ² (AWG 22)	5	PUR
Cable 10	Brown, blue, black	3 x 0,34 mm ² (AWG 22)	5	PUR shielded
Cable 11	Brown, white, blue, black	4 x 0,34 mm ² (AWG 22)	5	PUR shielded
Cable 12	Brown, white, blue, black, grey	5 x 0,34 mm ² (AWG 22)	5	PUR shielded

Ordering example for different cable lengths

C 112	10A	013	---	10
	2.0 m		020	
	5.0 m		050	
	10.0 m		100	

Standard cable lengths: 2 m and 5 m.
 Non-standard cable lengths upon request. Minimum order quantities will apply.



Male cable connector, straight, unshielded
with anti-vibration coupling nut and overmolded cable
A-coded

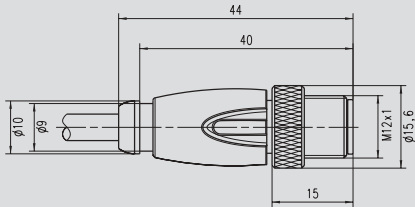

Contacts	Cable		Order No.
	jacket	length	
3	PVC	2 m	C112 10A013 020 10
		5 m	C112 10A013 050 10
		10 m	C112 10A013 100 10
	PUR	2 m	C112 10A043 020 10
		5 m	C112 10A043 050 10
		10 m	C112 10A043 100 10
4	PVC	2 m	C112 10A024 020 10
		5 m	C112 10A024 050 10
		10 m	C112 10A024 100 10
	PUR	2 m	C112 10A054 020 10
		5 m	C112 10A054 050 10
		10 m	C112 10A054 100 10
5	PVC	2 m	C112 10A035 020 10
		5 m	C112 10A035 050 10
		10 m	C112 10A035 100 10
	PUR	2 m	C112 10A065 020 10
		5 m	C112 10A065 050 10
		10 m	C112 10A065 100 10

Other cable lengths, cables and codings upon request.

3 contacts



4 contacts

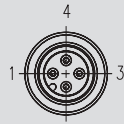

5 contacts

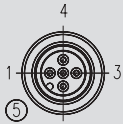

first mate – last break 2



Male cable connector, right angled, unshielded
with anti-vibration coupling nut and overmolded cable
A-coded

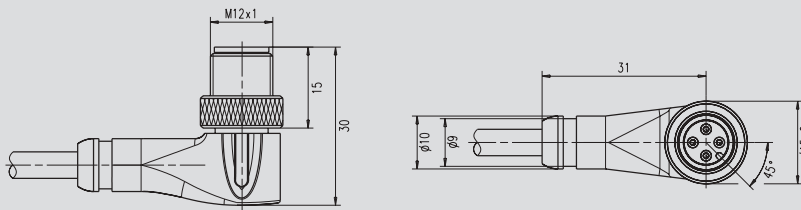

Contacts	Cable		Order No.
	jacket	length	
3	PVC	2 m	C112 10B013 020 10
		5 m	C112 10B013 050 10
		10 m	C112 10B013 100 10
	PUR	2 m	C112 10B043 020 10
		5 m	C112 10B043 050 10
		10 m	C112 10B043 100 10
4	PVC	2 m	C112 10B024 020 10
		5 m	C112 10B024 050 10
		10 m	C112 10B024 100 10
	PUR	2 m	C112 10B054 020 10
		5 m	C112 10B054 050 10
		10 m	C112 10B054 100 10
5	PVC	2 m	C112 10B035 020 10
		5 m	C112 10B035 050 10
		10 m	C112 10B035 100 10
	PUR	2 m	C112 10B065 020 10
		5 m	C112 10B065 050 10
		10 m	C112 10B065 100 10

Other cable lengths, cables and codings upon request.

3 contacts



4 contacts

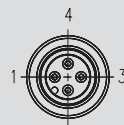

5 contacts

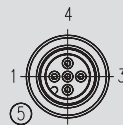

first mate – last break 2



Female cable connector, straight, unshielded
with anti-vibration coupling nut and overmolded cable
A-coded

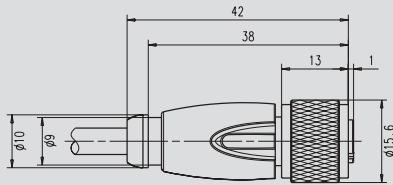

Contacts	Cable		Order No.
	jacket	length	
3	PVC	2 m	C112 10C013 020 10
		5 m	C112 10C013 050 10
		10 m	C112 10C013 100 10
	PUR	2 m	C112 10C043 020 10
		5 m	C112 10C043 050 10
		10 m	C112 10C043 100 10
4	PVC	2 m	C112 10C024 020 10
		5 m	C112 10C024 050 10
		10 m	C112 10C024 100 10
	PUR	2 m	C112 10C054 020 10
		5 m	C112 10C054 050 10
		10 m	C112 10C054 100 10
5	PVC	2 m	C112 10C035 020 10
		5 m	C112 10C035 050 10
		10 m	C112 10C035 100 10
	PUR	2 m	C112 10C065 020 10
		5 m	C112 10C065 050 10
		10 m	C112 10C065 100 10

Other cable lengths, cables and codings upon request.

3 contacts



4 contacts

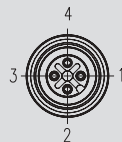

5 contacts

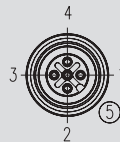

Female cable connector, right angled, unshielded
with anti-vibration coupling nut and overmolded cable
A-coded

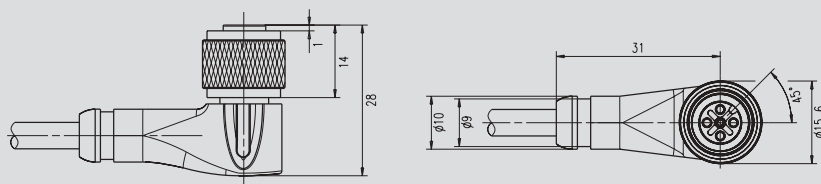

Contacts	Cable		Order No.
	jacket	length	
3	PVC	2 m	C112 10D013 020 10
		5 m	C112 10D013 050 10
		10 m	C112 10D013 100 10
	PUR	2 m	C112 10D043 020 10
		5 m	C112 10D043 050 10
		10 m	C112 10D043 100 10
4	PVC	2 m	C112 10D024 020 10
		5 m	C112 10D024 050 10
		10 m	C112 10D024 100 10
	PUR	2 m	C112 10D054 020 10
		5 m	C112 10D054 050 10
		10 m	C112 10D054 100 10
5	PVC	2 m	C112 10D035 020 10
		5 m	C112 10D035 050 10
		10 m	C112 10D035 100 10
	PUR	2 m	C112 10D065 020 10
		5 m	C112 10D065 050 10
		10 m	C112 10D065 100 10

Other cable lengths, cables and codings upon request.

3 contacts



4 contacts

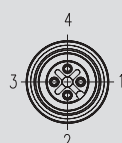

5 contacts

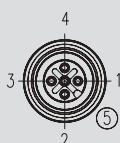



Male cable connector, straight, shielded
with anti-vibration coupling nut and overmolded cable
A-coded

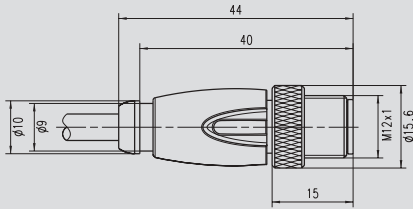

Contacts	Cable		Order No.
	jacket	length	
3	PVC	2 m	C112 11A073 020 10
		5 m	C112 11A073 050 10
		10 m	C112 11A073 100 10
	PUR	2 m	C112 11A103 020 10
		5 m	C112 11A103 050 10
		10 m	C112 11A103 100 10
4	PVC	2 m	C112 11A084 020 10
		5 m	C112 11A084 050 10
		10 m	C112 11A084 100 10
	PUR	2 m	C112 11A114 020 10
		5 m	C112 11A114 050 10
		10 m	C112 11A114 100 10
5	PVC	2 m	C112 11A095 020 10
		5 m	C112 11A095 050 10
		10 m	C112 11A095 100 10
	PUR	2 m	C112 11A125 020 10
		5 m	C112 11A125 050 10
		10 m	C112 11A125 100 10

Other cable lengths, cables and codings upon request.

3 contacts



4 contacts



5 contacts



Male cable connector, right angled, shielded
with anti-vibration coupling nut and overmolded cable
A-coded

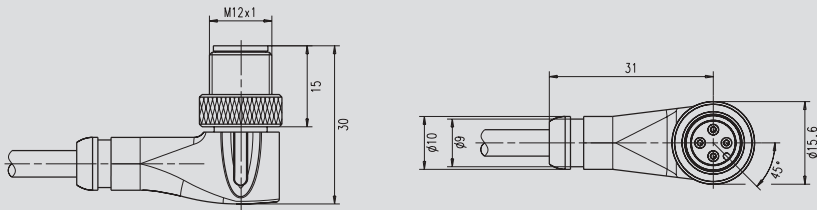

Contacts	Cable		Order No.
	jacket	length	
3	PVC	2 m	C112 11B073 020 10
		5 m	C112 11B073 050 10
		10 m	C112 11B073 100 10
	PUR	2 m	C112 11B103 020 10
		5 m	C112 11B103 050 10
		10 m	C112 11B103 100 10
4	PVC	2 m	C112 11B084 020 10
		5 m	C112 11B084 050 10
		10 m	C112 11B084 100 10
	PUR	2 m	C112 11B114 020 10
		5 m	C112 11B114 050 10
		10 m	C112 11B114 100 10
5	PVC	2 m	C112 11B095 020 10
		5 m	C112 11B095 050 10
		10 m	C112 11B095 100 10
	PUR	2 m	C112 11B125 020 10
		5 m	C112 11B125 050 10
		10 m	C112 11B125 100 10

Other cable lengths, cables and codings upon request.

3 contacts



4 contacts



5 contacts

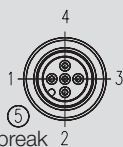



Female cable connector, straight, shielded
with anti-vibration coupling nut and overmolded cable
A-coded

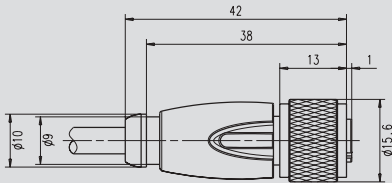

Contacts	Cable		Order No.
	jacket	length	
3	PVC	2 m	C112 11C073 020 10
		5 m	C112 11C073 050 10
		10 m	C112 11C073 100 10
	PUR	2 m	C112 11C103 020 10
		5 m	C112 11C103 050 10
		10 m	C112 11C103 100 10
4	PVC	2 m	C112 11C084 020 10
		5 m	C112 11C084 050 10
		10 m	C112 11C084 100 10
	PUR	2 m	C112 11C114 020 10
		5 m	C112 11C114 050 10
		10 m	C112 11C114 100 10
5	PVC	2 m	C112 11C095 020 10
		5 m	C112 11C095 050 10
		10 m	C112 11C095 100 10
	PUR	2 m	C112 11C125 020 10
		5 m	C112 11C125 050 10
		10 m	C112 11C125 100 10

Other cable lengths, cables and codings upon request.

3 contacts



4 contacts

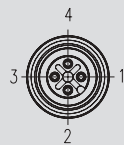

5 contacts

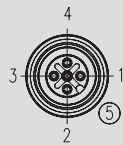

Female cable connector, right angled, shielded
with anti-vibration coupling nut and overmolded cable
A-coded

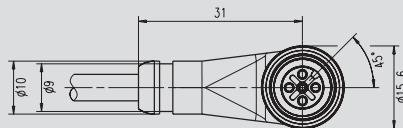
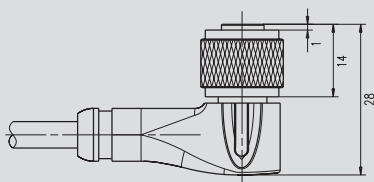

Contacts	Cable		Order No.
	jacket	length	
3	PVC	2 m	C112 11D073 020 10
		5 m	C112 11D073 050 10
		10 m	C112 11D073 100 10
	PUR	2 m	C112 11D103 020 10
		5 m	C112 11D103 050 10
		10 m	C112 11D103 100 10
4	PVC	2 m	C112 11D084 020 10
		5 m	C112 11D084 050 10
		10 m	C112 11D084 100 10
	PUR	2 m	C112 11D114 020 10
		5 m	C112 11D114 050 10
		10 m	C112 11D114 100 10
5	PVC	2 m	C112 11D095 020 10
		5 m	C112 11D095 050 10
		10 m	C112 11D095 100 10
	PUR	2 m	C112 11D125 020 10
		5 m	C112 11D125 050 10
		10 m	C112 11D125 100 10

Other cable lengths, cables and codings upon request.

3 contacts



4 contacts

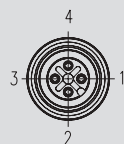

5 contacts

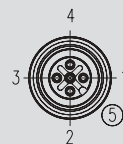

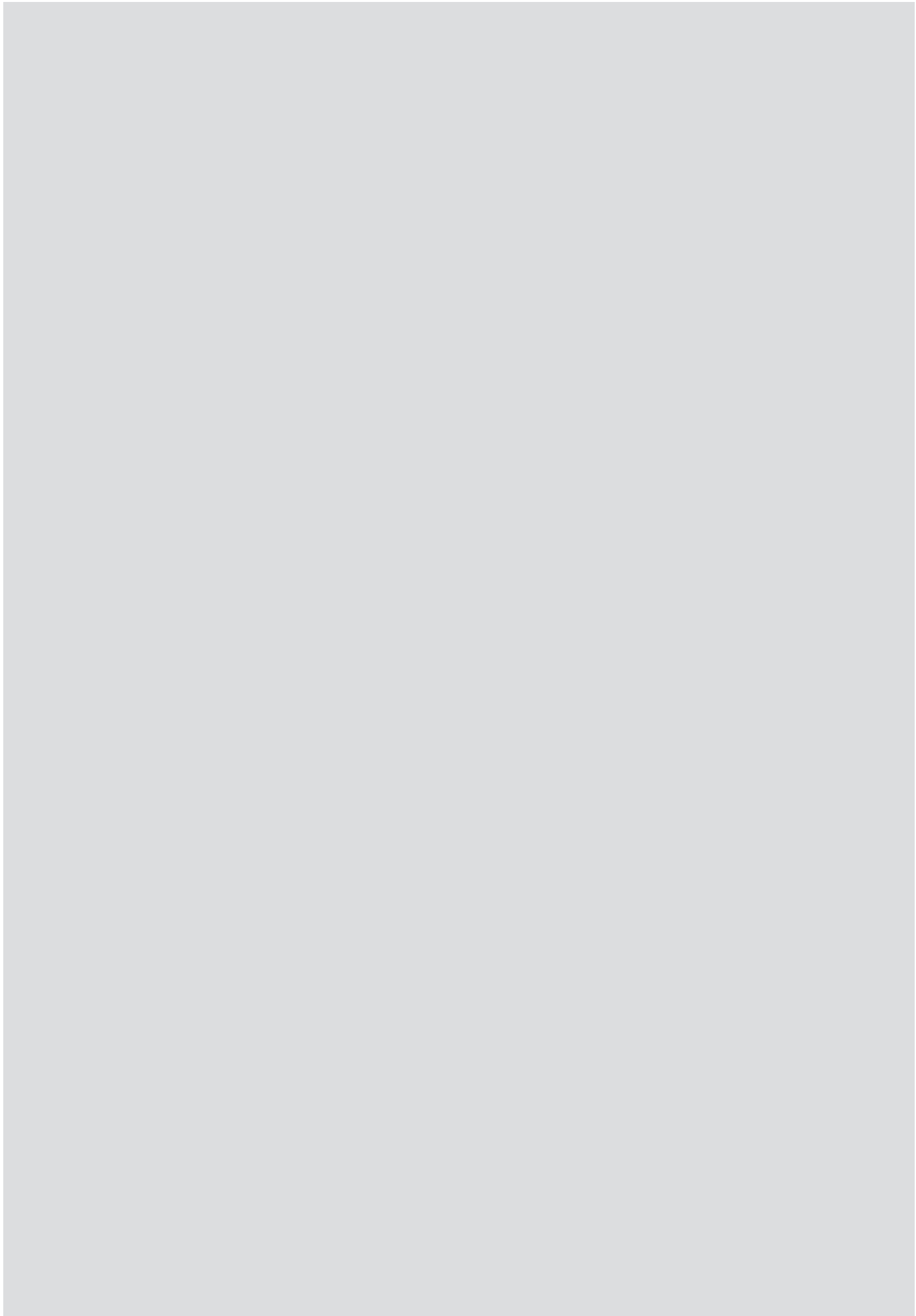

Male cable connectors / Female cable connectors customer assembly

C112 Series



Male cable connector, unshielded, straight and right angled, customer assembly... Page 16



Female cable connector, unshielded, straight and right angled, customer assembly... Page 16



Male cable connector and Female cable connector, shielded customer assembly... Page 17



Female cable connector, right angled customer assembly... Page 17

Description

Male and female cable connectors, straight and right angled for customer assembly.

Female cable connectors, right angled, for customer assembly, with electronic circuit.





Male cable connectors, unshielded
Metal locking nut
 for customer assembly, A-coded

Screw connection
 4 Ampere
 wire size
 0,25 - 0,75 mm²
 cable diameter
 4 - 6 mm

Contacts	Voltage	Design	Order No.
4	250 V	straight	C112 13A004 000 24
		right angled	C112 13B004 000 24
5	60 V	straight	C112 13A005 000 24
		right angled	C112 13B005 000 24

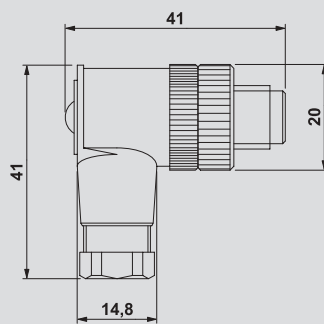
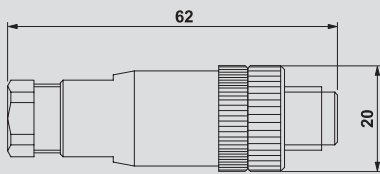

Female cable connectors, unshielded
Metal locking nut
 for customer assembly, A-coded

Screw connection
 4 Ampere
 wire size
 0,25 - 0,75 mm²
 cable diameter
 4 - 6 mm

Contacts	Voltage	Design	Order No.
4	250 V	straight	C112 13C004 000 24
		right angled	C112 13D004 000 24
5	60 V	straight	C112 13C005 000 24
		right angled	C112 13D005 000 24

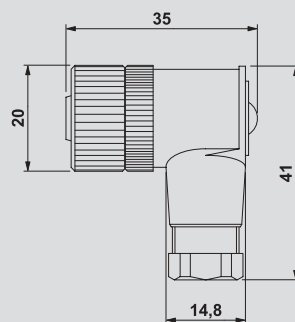
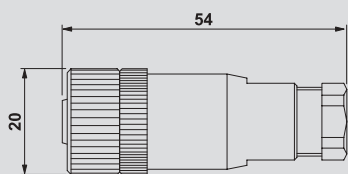

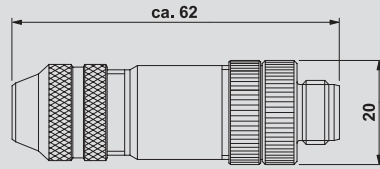

Male cable connectors, shielded, straight

for customer assembly, A-coded

Screw connection

4 Ampere

wire size

0,25-0,75 mm²

cable diameter

4-6 mm

Contacts	Voltage	Order No.
4	250 V	C112 14A004 000 24
5	60 V	C112 14A005 000 24

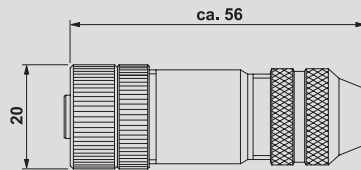

Female cable connector, shielded, straight

for customer assembly, A-coded

Screw connection

4 Ampere

wire size

0,25-0,75 mm²

cable diameter

4-6 mm

Contacts	Voltage	Order No.
4	250 V	C112 14A004 000 24
5	60 V	C112 14A005 000 24



Female cable connector, right angled
customer assembly

Contacts	LED 1	LED 2	Circuit	Order No.
3	-	-	1	C112 13D004 000 01
3+PE	-	-	2	C112 13D004 000 02
3	yel.	-	3	C112 13D004 000 03
		-	4	C112 13D004 000 04
		-	5	C112 13D004 000 05
3	gre.	yel.	6	C112 13D004 000 06
		-	7	C112 13D004 000 07
		-	8	C112 13D004 000 08

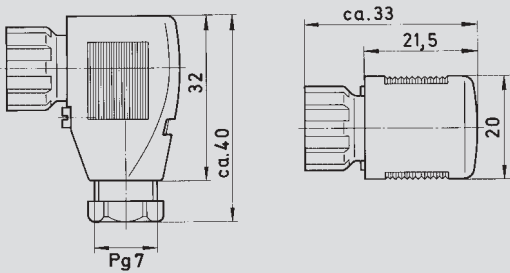

Wiring scheme

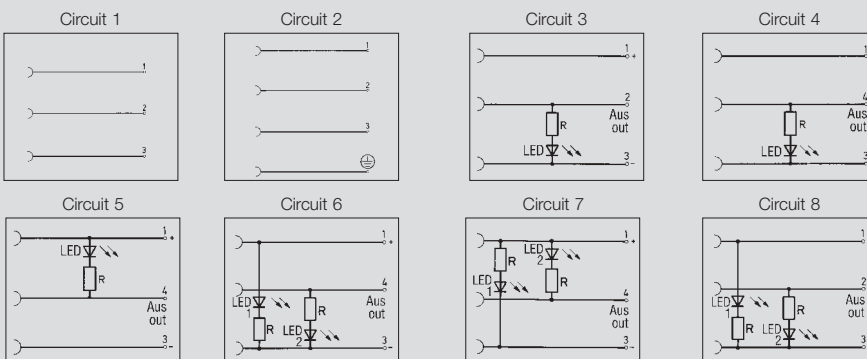

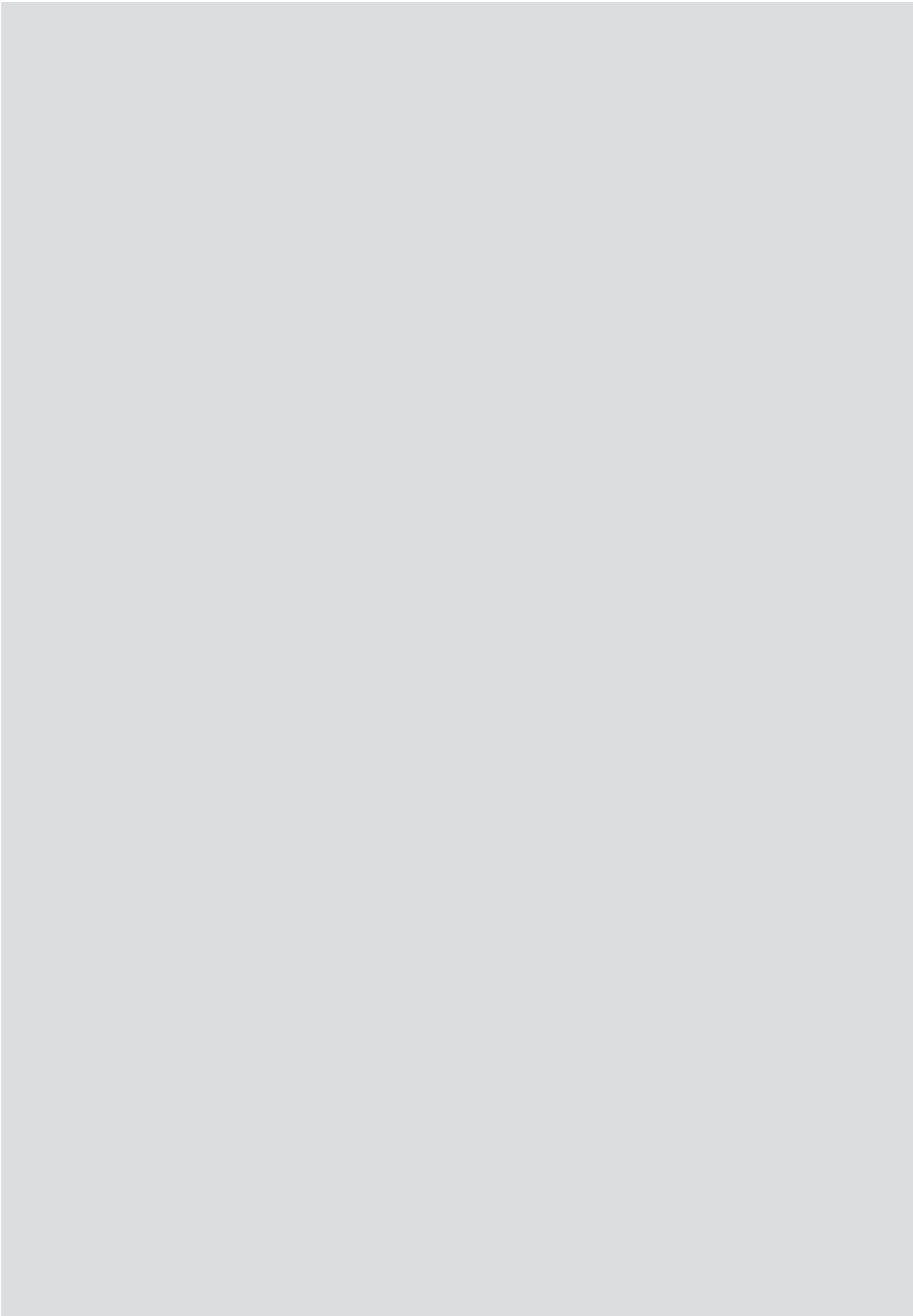

Cordsets overmolded

C 112 Series



Cordset, unshielded
Male connector, straight/Female connector, straight
overmolded with anti-vibration coupling nut ... Page 22



Cordset, unshielded
Male connector, straight/Female connector, right angled
overmolded with anti-vibration coupling nut ... Page 22

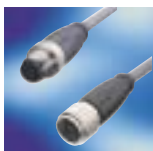

Cordset, shielded
Male connector, straight/Female connector, straight
overmolded with anti-vibration coupling nut ... Page 23

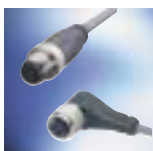

Cordset, shielded
Male connector, straight/Female connector, right angled
overmolded with anti-vibration coupling nut ... Page 23

Description

M12 cordset with male and female connector, straight or right angled and standard cable with PVC or PUR insulation.
Other combinations on request.

Shielded EMI protected M12 cordsets with male and female connector, straight or right angled, and standard cable with PVC or PUR insulation.
Other combinations on request.



General characteristics	Standard	Standard Version	Shielded
Number of contacts		3 / 4 / 5 ³⁾	3 / 4 / 5 ³⁾

Electrical characteristics

Contact resistance	IEC 60 512-2, test 2 a	≤ 10 mΩ (without cable)	
Current carrying capacity	IEC 60 512-3, test 5 b	4 A at T _U = 40°C	
Rated voltage	IEC 60 664-1 ²⁾	3+4 cont. 250 V AC/DC	3+4 cont. 60 V AC/DC
	IEC 60 664-1 ²⁾	5 cont. 60 V AC/DC	5 cont. 60 V AC/DC
Rated impulse voltage	IEC 60 664-1 ²⁾	3+4 cont. 2,5 kV	3+4 cont. 0,8 kV
Insulation resistance	IEC 60 664-1 ²⁾	5 cont. 1,5 kV	5 cont. 0,8 kV
	IEC 60 512-2, test 3 a	> 10 ⁸ Ω	
Pollution degree	IEC 60 664-1 ²⁾	3 ¹⁾	
Material group	IEC 60 664-1 ²⁾	I	
Test voltage	IEC 60 644-1 ²⁾	3 + 4 cont. 1,4 kV AC 5 cont. 1,0 kV AC	0,5 kV AC

Climatic characteristics

Climatic category	IEC 60 668-1	25 / 85 / 21	
Temperature range	IEC 60 512-6, test 11 i+j	-25°C - +85°C -13°F - +185°F	

Materials

Contact insert		TPU	
Contact plating		Au	
Overmolding		TPU	
Housing		-	
Knurled screw / knurled nut		CuZn nickel plated	
O-Ring		Viton	

Mechanical characteristics

Protection class	IEC 60 529	IP 65 and IP 67, when properly mated	
Mechanical operation	IEC 60 512-5, test 9 a	≥ 100 mating cycles	
Insertion force	IEC 60 512-7, test 13 b	≤ 25 N	
Withdrawal force	IEC 60 512-7, test 13 b	≤ 30 N	

Other technical characteristics

Type of termination		crimp (overmolded)	
Wire size		0,34 mm ² (AWG 22)	
Flammability		UL 94 HB	
Locking		Screw coupling	

1) In mated position only

2) IEC 60664-1 corresponds to DIN VDE 0110

3) Contact no. 5 is "first mate – last break" and can be used for grounding purpose. When grounding the customer must mark the wire.

Furthermore the user has to ensure that this connector is not mated with such connectors where contact no 5 is under voltage

Cable construction PVC

- Fair oil and chemical resistance
- Especially suited for dry areas

	Color code	Conductors	Cable jacket	
			Ø mm	material
Cable 01	Brown, blue, black	3 x 0,34 mm ² (AWG 22)	5	PVC
Cable 02	Brown, white, blue, black	4 x 0,34 mm ² (AWG 22)	5	PVC
Cable 03	Brown, white, blue, black, grey	5 x 0,34 mm ² (AWG 22)	5	PVC
Cable 07	Brown, blue, black	3 x 0,34 mm ² (AWG 22)	5	PVC shielded
Cable 08	Brown, white, blue, black	4 x 0,34 mm ² (AWG 22)	5	PVC shielded
Cable 09	Brown, white, blue, black, grey	5 x 0,34 mm ² (AWG 22)	5	PVC shielded

Cable construction PUR

- Good oil and chemical resistance
- Especially suited for applications in abrasive environments.

	Color code	Conductors	Cable jacket	
			Ø mm	material
Cable 04	Brown, blue, black	3 x 0,34 mm ² (AWG 22)	5	PUR
Cable 05	Brown, white, blue, black	4 x 0,34 mm ² (AWG 22)	5	PUR
Cable 06	Brown, white, blue, black, grey	5 x 0,34 mm ² (AWG 22)	5	PUR
Cable 10	Brown, blue, black	3 x 0,34 mm ² (AWG 22)	5	PUR shielded
Cable 11	Brown, white, blue, black	4 x 0,34 mm ² (AWG 22)	5	PUR shielded
Cable 12	Brown, white, blue, black, grey	5 x 0,34 mm ² (AWG 22)	5	PUR shielded

Ordering example for different cable lengths

C 112	20C	013	---
	0.6 m	006	
	1.0 m	010	
	2.0 m	020	

Standard cable length: 0.6 m, 1.0 m and 2.0 m.
Other cable lengths or cables upon request.



Cordset, unshielded
Male connector, straight /
Female connector, straight
 with anti-vibration coupling nut
 A-coded

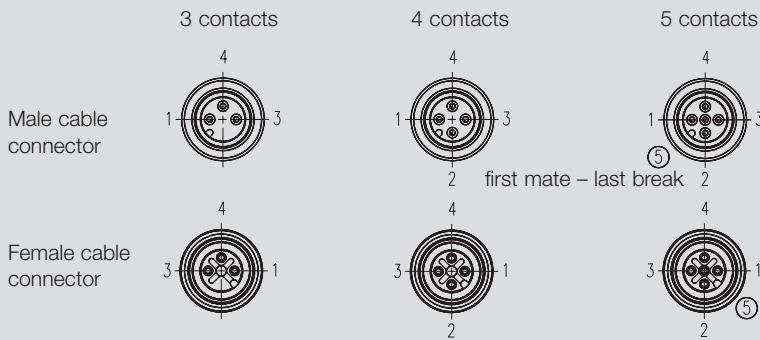
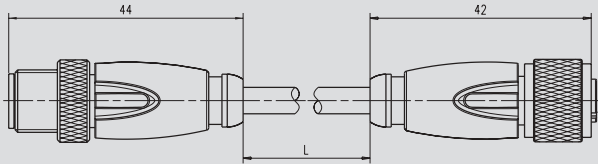

Contacts	Cable		Order No.
	jacket	length	
3	PVC	0,6 m	C112 20C013 006 10
		1,0 m	C112 20C013 010 10
		2,0 m	C112 20C013 020 10
	PUR	0,6 m	C112 20C043 006 10
		1,0 m	C112 20C043 010 10
		2,0 m	C112 20C043 020 10
4	PVC	0,6 m	C112 20C024 006 10
		1,0 m	C112 20C024 010 10
		2,0 m	C112 20C024 020 10
	PUR	0,6 m	C112 20C054 006 10
		1,0 m	C112 20C054 010 10
		2,0 m	C112 20C054 020 10
5	PVC	0,6 m	C112 20C035 006 10
		1,0 m	C112 20C035 010 10
		2,0 m	C112 20C035 020 10
	PUR	0,6 m	C112 20C065 006 10
		1,0 m	C112 20C065 010 10
		2,0 m	C112 20C065 020 10

Other cable lengths upon request.



Cordset, unshielded
Male connector, straight /
Female connector, right angled
 with anti-vibration coupling nut
 A-coded

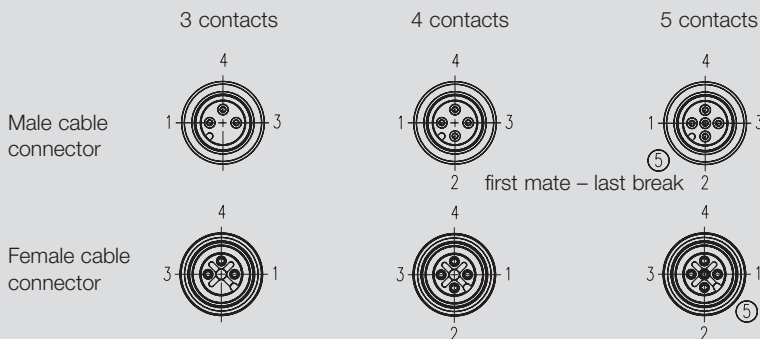
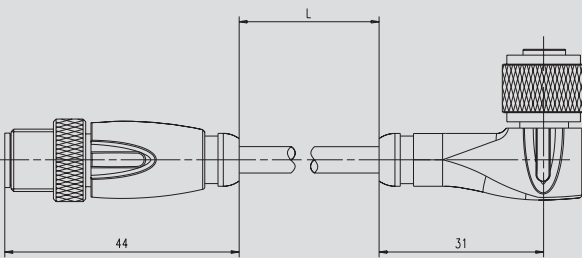

Contacts	Cable		Order No.
	jacket	length	
3	PVC	0,6 m	C112 20D013 006 10
		1,0 m	C112 20D013 010 10
		2,0 m	C112 20D013 020 10
	PUR	0,6 m	C112 20D043 006 10
		1,0 m	C112 20D043 010 10
		2,0 m	C112 20D043 020 10
4	PVC	0,6 m	C112 20D024 006 10
		1,0 m	C112 20D024 010 10
		2,0 m	C112 20D024 020 10
	PUR	0,6 m	C112 20D054 006 10
		1,0 m	C112 20D054 010 10
		2,0 m	C112 20D054 020 10
5	PVC	0,6 m	C112 20D035 006 10
		1,0 m	C112 20D035 010 10
		2,0 m	C112 20D035 020 10
	PUR	0,6 m	C112 20D065 006 10
		1,0 m	C112 20D065 010 10
		2,0 m	C112 20D065 020 10

Other cable lengths upon request.



Cordset, shielded
Male connector, straight /
Female connector, straight
 with anti-vibration coupling nut
 A-coded

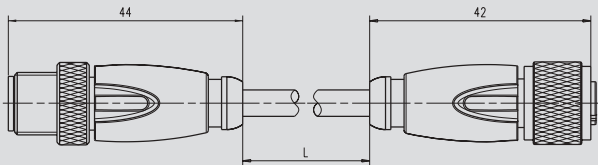

Contacts	Cable		Order No.
	jacket	length	
3	PVC	0,6 m	C112 21C073 006 10
		1,0 m	C112 21C073 010 10
		2,0 m	C112 21C073 020 10
	PUR	0,6 m	C112 21C103 006 10
		1,0 m	C112 21C103 010 10
		2,0 m	C112 21C103 020 10
4	PVC	0,6 m	C112 21C084 006 10
		1,0 m	C112 21C084 010 10
		2,0 m	C112 21C084 020 10
	PUR	0,6 m	C112 21C114 006 10
		1,0 m	C112 21C114 010 10
		2,0 m	C112 21C114 020 10
5	PVC	0,6 m	C112 21C095 006 10
		1,0 m	C112 21C095 010 10
		2,0 m	C112 21C095 020 10
	PUR	0,6 m	C112 21C125 006 10
		1,0 m	C112 21C125 010 10
		2,0 m	C112 21C125 020 10

Other cable lengths upon request.

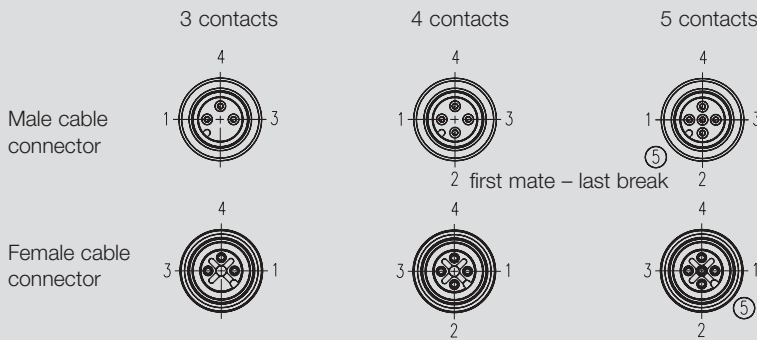

Cordset, shielded
Male connector, straight /
Female connector, right angled
 with anti-vibration coupling nut
 A-coded

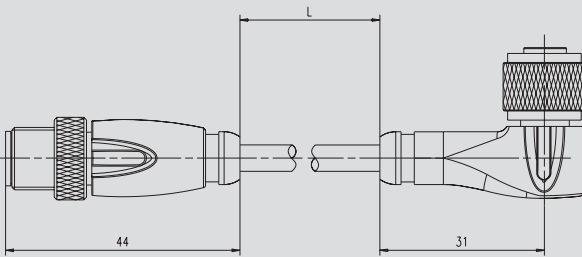

Contacts	Cable		Order No.
	jacket	length	
3	PVC	0,6 m	C112 21D073 006 10
		1,0 m	C112 21D073 010 10
		2,0 m	C112 21D073 020 10
	PUR	0,6 m	C112 21D103 006 10
		1,0 m	C112 21D103 010 10
		2,0 m	C112 21D103 020 10
4	PVC	0,6 m	C112 21D084 006 10
		1,0 m	C112 21D084 010 10
		2,0 m	C112 21D084 020 10
	PUR	0,6 m	C112 21D114 006 10
		1,0 m	C112 21D114 010 10
		2,0 m	C112 21D114 020 10
5	PVC	0,6 m	C112 21D095 006 10
		1,0 m	C112 21D095 010 10
		2,0 m	C112 21D095 020 10
	PUR	0,6 m	C112 21D125 006 10
		1,0 m	C112 21D125 010 10
		2,0 m	C112 21D125 020 10

Other cable lengths upon request.

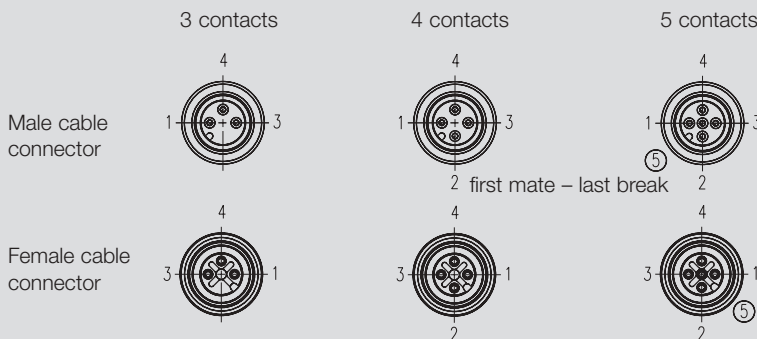

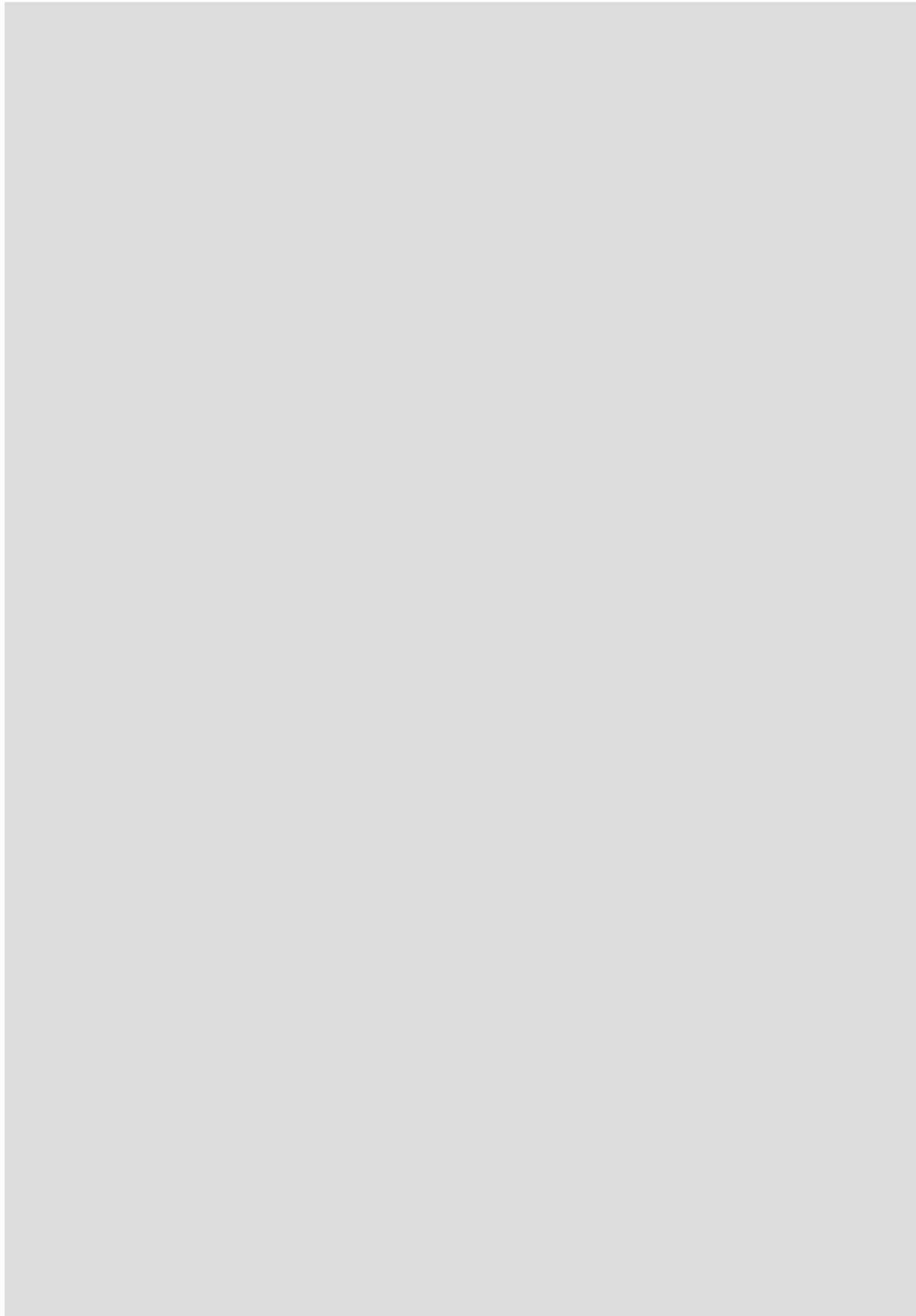

Male and female panel connectors

C 112 Series

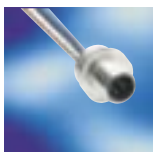

Male panel connector, front mounting assembled with wires ... Page 27

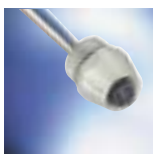

Female panel connector, front mounting assembled with wires ... Page 27

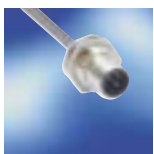

Male panel connector, rear mounting assembled with wires ... Page 28

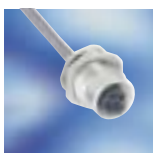

Female panel connector, rear mounting assembled with wires ... Page 28



Male panel connector installation version ... Page 29



Female panel connector, rear mounting pcb-mount type ... Page 29



Male panel connector, rear mounting pcb-mount type ... Page 29

Description

M12 male and female panel connectors for front or rear mounting, assembled with wires.

M12 male and female panel connectors with pcb-mount type.

M12 male panel connectors installation version.



General characteristics	Standard	Standard Version	Customer Assembly
Number of contacts		3 / 4 / 5 / 8	3 / 4

Electrical characteristics

Contact resistance	IEC 60 512-2, test 2 a	≤ 10 mΩ (without cable)	≤ 10 mΩ
Current carrying capacity	IEC 60 512-3, test 5 b	3+4+5-cont. 4 A at T _U = 40°C	4 A at T _U = 40°C
	IEC 60 512-3, test 5 b	8-cont. 2 A at T _U = 40°C	
Rated voltage	IEC 60 664-1 ²⁾	3+4 cont. 250 V AC/DC	250 V AC/DC
	IEC 60 664-1 ²⁾	5 cont. 60 V AC/DC	
	IEC 60 664-1 ²⁾	8-cont. 30 V AC/DC	
Rated impulse voltage unrated	IEC 60 664-1 ²⁾	3+4 cont. 2,5 kV	2,5 kV
	IEC 60 664-1 ²⁾	5 cont. 1,5 kV	
	IEC 60 664-1 ²⁾	8-cont. 0,8 kV	
Insulation resistance	IEC 60 512-2, test 3 a	> 10 ⁸ Ω	> 10 ⁸ Ω
Pollution degree	IEC 60 664-1 ²⁾	3 ¹⁾	3
Material group	IEC 60 664-1 ²⁾	I	II
Test voltage	IEC 60 664-1 ²⁾	3 + 4 cont. 1,4 kV AC 5 cont. 1,0 kV AC	

Climatic characteristics

Climatic category	IEC 60 068-1	25 / 85 / 21	30 / 100 / 56
Temperature range	IEC 60 512-6, test 1.1	-25°C - +85°C -13°F - +185°F	-30°C - +100°C -22°F - +212°F

Materials

Contact insert		TPU	PA
Contact plating		Au	Ag
Housing / Mounting screw		CuZn nickel plated	PA
O-Ring		Viton	NBR

Mechanical characteristics

Protection class	IEC 60 529	IP 65 and IP 67 when properly mated	IP 65 when properly mated
Mechanical operation	IEC 60 512-5, test 9 a	≥ 100 mating cycles	≥ 50 mating cycles
Insertion force	IEC 60 512-7, test 13 b	≤ 25 N	≤ 25 N
Withdrawal force	IEC 60 512-7, test 13 b	≤ 30 N	≤ 30 N

Other technical characteristics

Type of termination		crimp	solder
Wire size		0,34 mm ² (AWG 22)	0,14 - 0,5 mm ²
Flammability		UL 94 HB	UL 94 V-0
Locking		Screw coupling	Screw coupling

1) In mated position only

2) IEC 60664-1 corresponds to DIN VDE 0110

Wire construction

	Color code	Conductors	Insulation
Wire 01	Brown, blue, black	3 x 0,34 mm ² (AWG 22)	PVC
Wire 02	Brown, white, blue, black	4 x 0,34 mm ² (AWG 22)	PVC
Wire 03	Brown, white, blue, black, grey	5 x 0,34 mm ² (AWG 22)	PVC
Wire 04	Brown, white, blue, grey, green, yellow, red, pink	8 x 0,25 mm ² (AWG 24)	PVC

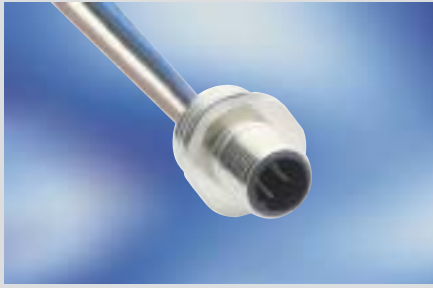

Male panel connector, front mounting with PVC-insulated wire spanner width SW 17 A-coded

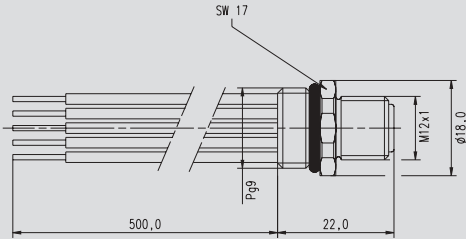

Contacts	Colors of wire insulation	Mounting thread	Lead length	Order No.
3	Brown-blue-black	PG9	200 mm	C112 30A013 002 10
			500 mm	C112 30A013 005 10
		M 16 x 1,5	200 mm	C112 30A013 002 30
			500 mm	C112 30A013 005 30
4	Brown-white-blue-black	PG9	200 mm	C112 30A024 002 10
			500 mm	C112 30A024 005 10
		M 16 x 1,5	200 mm	C112 30A024 002 30
			500 mm	C112 30A024 005 30
5	Brown-white-blue-black-grey	PG9	200 mm	C112 30A035 002 10
			500 mm	C112 30A035 005 10
		M 16 x 1,5	200 mm	C112 30A035 002 30
			500 mm	C112 30A035 005 30
8	Brown-white-blue-grey-green-yellow-red-pink	PG9	200 mm	C112 30A048 002 10
			500 mm	C112 30A048 005 10
		M 16 x 1,5	200 mm	C112 30A048 002 30
			500 mm	C112 30A048 005 30

Other lead lengths and codings upon request.

3 contacts



4 contacts

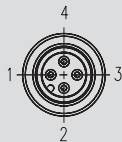

5 contacts

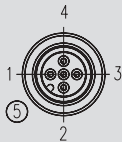

8 contacts

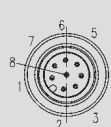

Female panel connector, front mounting with PVC-insulated wire spanner width SW 17 A-coded

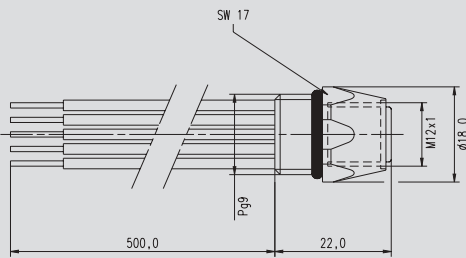

Contacts	Colors of wire insulation	Mounting thread	Lead length	Order No.
3	Brown-blue-black	PG9	200 mm	C112 30C013 002 10
			500 mm	C112 30C013 005 10
		M 16 x 1,5	200 mm	C112 30C013 002 30
			500 mm	C112 30C013 005 30
4	Brown-white-blue-black	PG9	200 mm	C112 30C024 002 10
			500 mm	C112 30C024 005 10
		M 16 x 1,5	200 mm	C112 30C024 002 30
			500 mm	C112 30C024 005 30
5	Brown-white-blue-black-grey	PG9	200 mm	C112 30C035 002 10
			500 mm	C112 30C035 005 10
		M 16 x 1,5	200 mm	C112 30C035 002 30
			500 mm	C112 30C035 005 30
8	Brown-white-blue-grey-green-yellow-red-pink	PG9	200 mm	C112 30C048 002 10
			500 mm	C112 30C048 005 10
		M 16 x 1,5	200 mm	C112 30C048 002 30
			500 mm	C112 30C048 005 30

Other lead lengths and codings upon request.

3 contacts



4 contacts

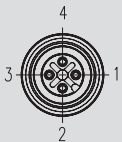

5 contacts



8 contacts

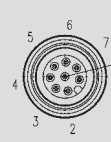

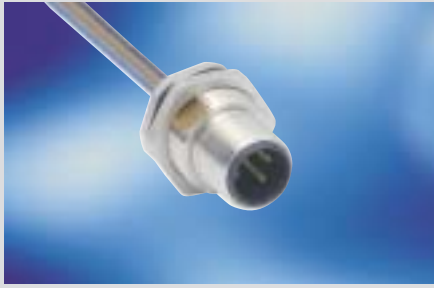

Male panel connector, rear mounting with PVC-insulated wire spanner width SW 17 A-coded

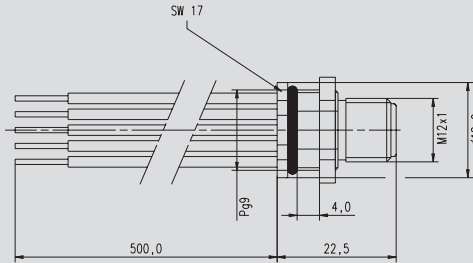

Contacts	Colors of wire insulation	Mounting thread	Lead length	Order No.
3	Brown-blue-black	PG9	200 mm	C112 30B013 002 10
			500 mm	C112 30B013 005 10
		M 16 x 1,5	200 mm	C112 30B013 002 30
			500 mm	C112 30B013 005 30
4	Brown-white-blue-black	PG9	200 mm	C112 30B024 002 10
			500 mm	C112 30B024 005 10
		M 16 x 1,5	200 mm	C112 30B024 002 30
			500 mm	C112 30B024 005 30
5	Brown-white-blue-black-grey	PG9	200 mm	C112 30B035 002 10
			500 mm	C112 30B035 005 10
		M 16 x 1,5	200 mm	C112 30B035 002 30
			500 mm	C112 30B035 005 30
8	Brown-white-blue-grey-green-yellow-red-pink	PG9	200 mm	C112 30B048 002 10
			500 mm	C112 30B048 005 10
		M 16 x 1,5	200 mm	C112 30B048 002 30
			500 mm	C112 30B048 005 30

Other lead lengths and codings upon request.

3 contacts



4 contacts



5 contacts

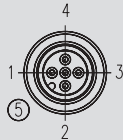

8 contacts

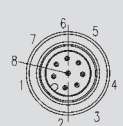

Female panel connector, rear mounting with PVC-insulated wire spanner width SW 17 A-coded

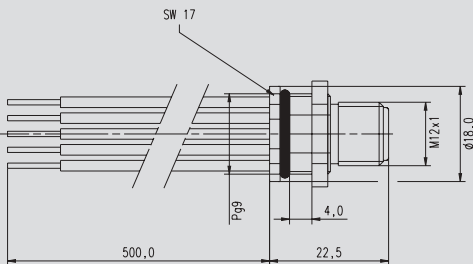

Contacts	Colors of wire insulation	Mounting thread	Lead length	Order No.
3	Brown-blue-black	PG9	200 mm	C112 30D013 002 10
			500 mm	C112 30D013 005 10
		M 16 x 1,5	200 mm	C112 30D013 002 30
			500 mm	C112 30D013 005 30
4	Brown-white-blue-black	PG9	200 mm	C112 30D024 002 10
			500 mm	C112 30D024 005 10
		M 16 x 1,5	200 mm	C112 30D024 002 30
			500 mm	C112 30D024 005 30
5	Brown-white-blue-black-grey	PG9	200 mm	C112 30D035 002 10
			500 mm	C112 30D035 005 10
		M 16 x 1,5	200 mm	C112 30D035 002 30
			500 mm	C112 30D035 005 30
8	Brown-white-blue-grey-green-yellow-red-pink	PG9	200 mm	C112 30D048 002 10
			500 mm	C112 30D048 005 10
		M 16 x 1,5	200 mm	C112 30D048 002 30
			500 mm	C112 30D048 005 30

Other lead lengths and codings upon request.

3 contacts



4 contacts

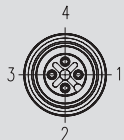

5 contacts



8 contacts

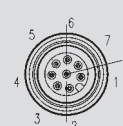



**Male panel connector,
rear mounting
pcb-mount type**

Contacts	Order No.
4	C112 30X004 000 XX
5	C112 30X005 000 XX

Please indicate contact length coding, PG- or metric mounting thread to allow us to determine your connector type.

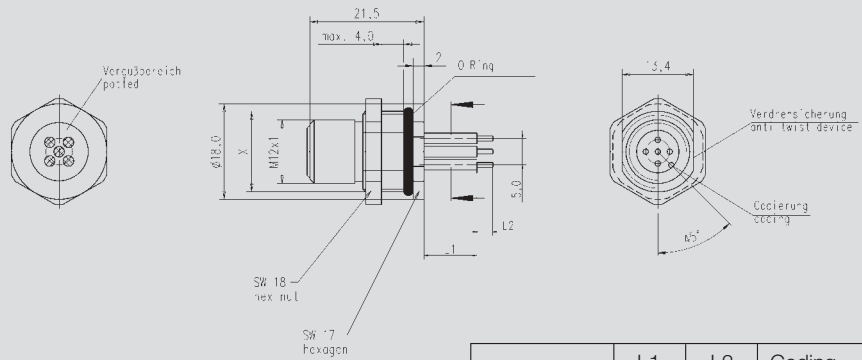

	L1	L2	Coding
PG 9			A
M 16			B



**Female panel connector,
rear mounting
pcb-mount type**

Contacts	Order No.
4	C112 30X004 000 XX
5	C112 30X005 000 XX

Please indicate contact length coding, PG- or metric mounting thread to allow us to determine your connector type.

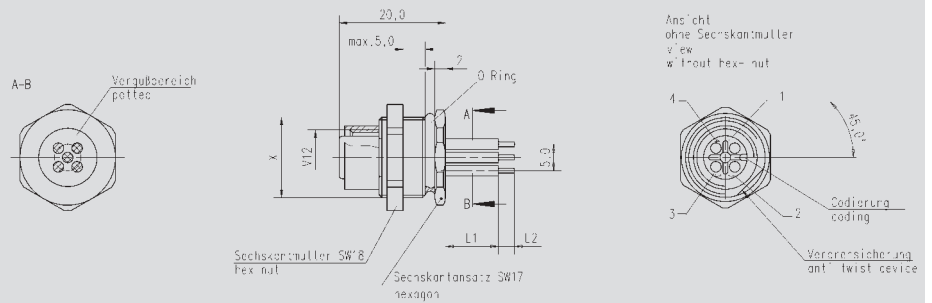

	L1	L2	Coding
PG 9			A
M 16			B



**Male panel connector,
installation version**

Contacts	Order No.
3+PE	C112 31A003 000 10
4	C112 31A004 000 10

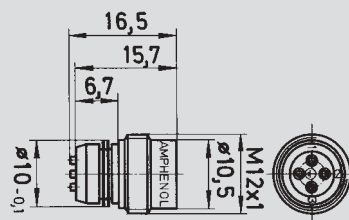

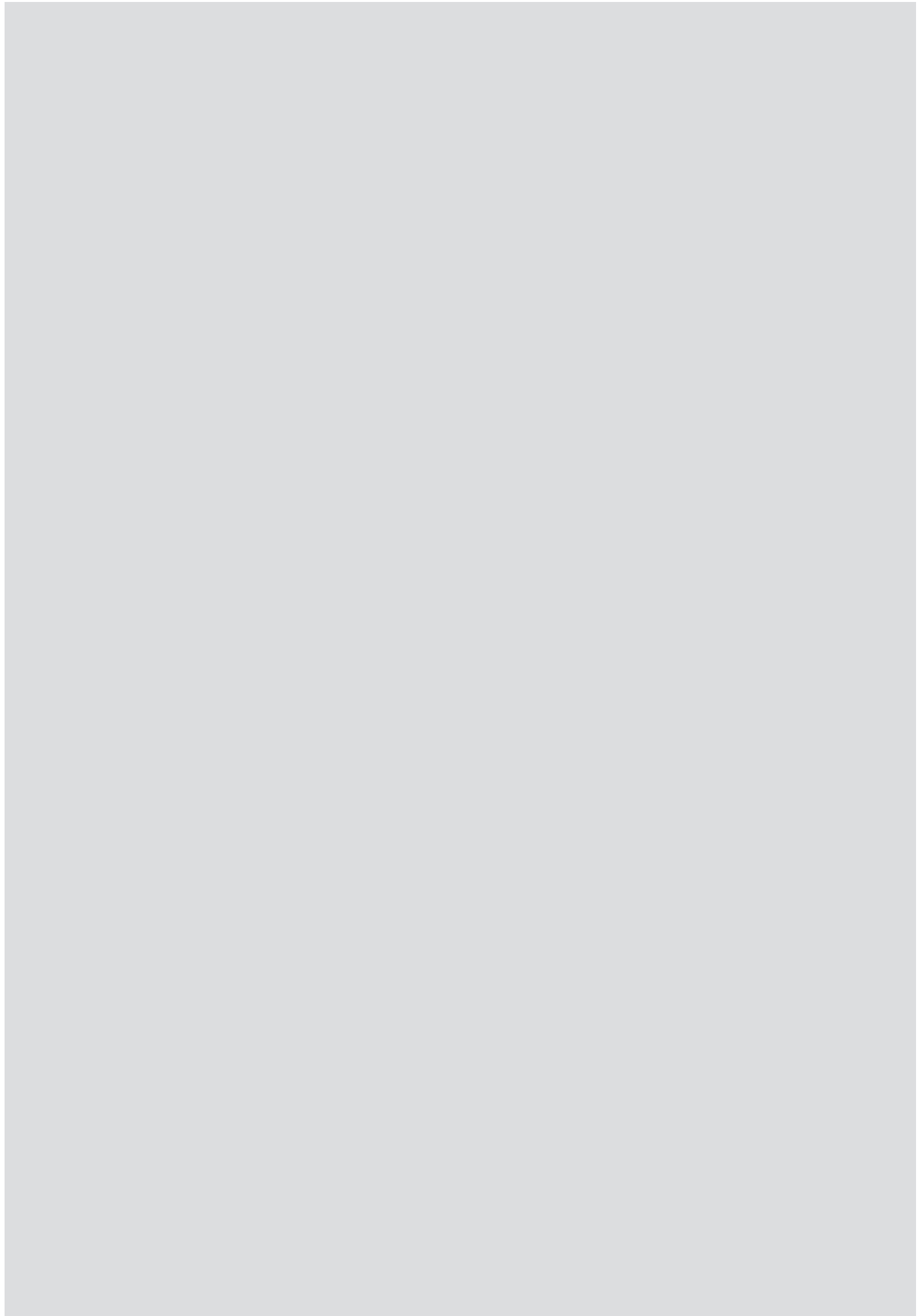

Distributors

C 112 Series



Y-Distributor ... Page 33



Distribution boxes ... Page 34
4-, 6- and 8-way

Description

M12-Y-Distributor for twofold distribution.

Ready to use M12-Distribution boxes with 4-, 6- and 8-way distribution.



General characteristics	Standard	Y-Distributor	Distribution Box
Contacts		3 / 4 / 5	5

Electrical characteristics

Contact resistance	IEC 60 512-2, test 2 a	≤ 5 mΩ (single contact) ≤ 25 mΩ (complete circuit)	≤ 5 mΩ (single contact)
Current carrying capacity	IEC 60 512-3, test 5 b	4 A / 40°C	2 A / 40°C
Rated voltage	IEC 60 664-1 ²⁾	60 V AC/DC	30 V
Rated impulse voltage	IEC 60 664-1 ²⁾	0,8 kV	0,8 kV
Insulation resistance	IEC 60 512-2, test 3 a	> 10 ⁸ Ω	> 10 ⁸ Ω
Pollution degree	IEC 60 664-1 ²⁾	3 ¹⁾	2
Material group	IEC 60 664-1 ²⁾	I	–
Test voltage	IEC 60 664-1 ²⁾	0,5 kV AC	0,5 kV AC

Climatic characteristics

Climatic category	IEC 60 068-1	25 / 85 / 21	–
Temperature range	IEC 60 512-6, test 11 i+j	–25°C - +85°C –13°F - +185°F	–20°C - +90°C –4°F - +194°F

Materials

Contact insert		TPU	PBT
Contact plating		Au	Au
Body		TPU	–
Housing		–	PBT
Knurled screw / knurled nut		CuZn nickel plated	–
O-Ring		Viton	–

Mechanical characteristics

Protection class	IEC 60 529	IP 67 when properly mated	IP 67 when properly mated
Mechanical operation	IEC 60 512-5, test 9 a	≥ 100 mating cycles	≥ 100 mating cycles
Insertion force	IEC 60 512-7, test 13 b	≤ 25 N	≤ 25 N
Withdrawal force	IEC 60 512-7, test 13 b	≤ 30 N	≤ 30 N

Other technical characteristics

Type of termination		crimp (overmolded)	solder
Wire size		0,34 mm ² (AWG 22)	–
Flammability		UL 94 HB	UL 94 V-0
Locking		Screw coupling	Screw coupling

1) In mated position only

2) IEC 60664-1 corresponds to DIN VDE 0110



Y-Distributor

A-coded

One entrance, two parallel exits.

Other Connections upon request.

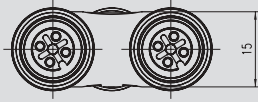

Verdrahtungsplan circuit diagram

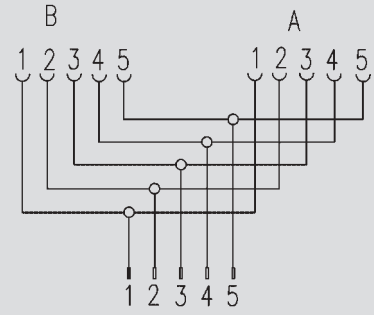

	Contacts	Design	Order No.
unshielded	4	m / fm - fm	C112 40A004 000 10
		fm / m - m	C112 40B004 000 10
		fm / m - fm	C112 40E004 000 10
		m / fm - m	C112 40F004 000 10
	5	m / fm - fm	C112 40A005 000 10
		fm / m - m	C112 40B005 000 10
		fm / m - fm	C112 40E005 000 10
		m / fm - m	C112 40F005 000 10

m = male; fm = female

	Contacts	Design	Order No.
shielded	4	m / fm - fm	C112 41A004 000 10
		fm / m - m	C112 41B004 000 10
		fm / m - fm	C112 41E004 000 10
		m / fm - m	C112 41F004 000 10
	5	m / fm - fm	C112 41A005 000 10
		fm / m - m	C112 41B005 000 10
		fm / m - fm	C112 41E005 000 10
		m / fm - m	C112 41F005 000 10

m = male; fm = female

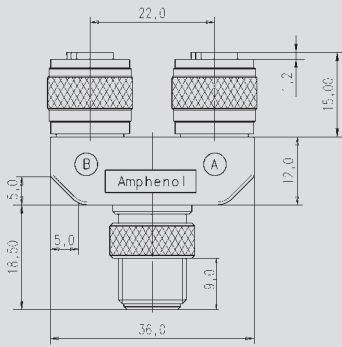

Version A: m / fm - fm

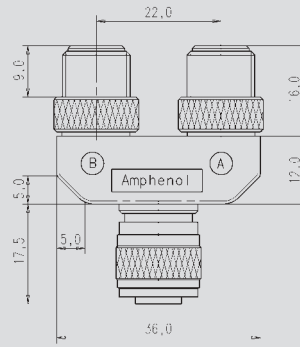

Version B: fm / m - m

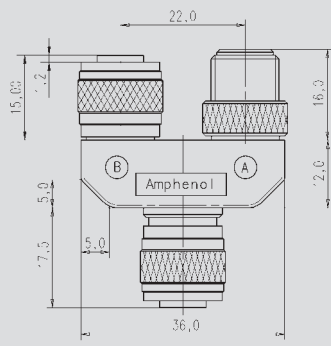

Version E: fm / m - fm

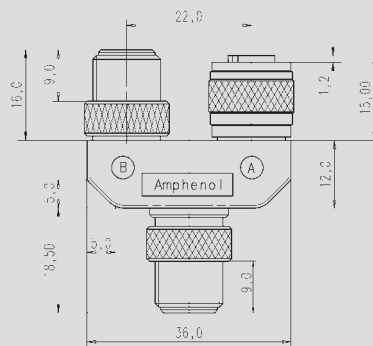

Version F: m / fm - m



Distribution boxes
4-, 6- and 8-way

Contacts	Distribution	Order No.
5	4-way	C112 50U004 000 10
	6-way	C112 50U006 000 10
	8-way	C112 50U008 000 10

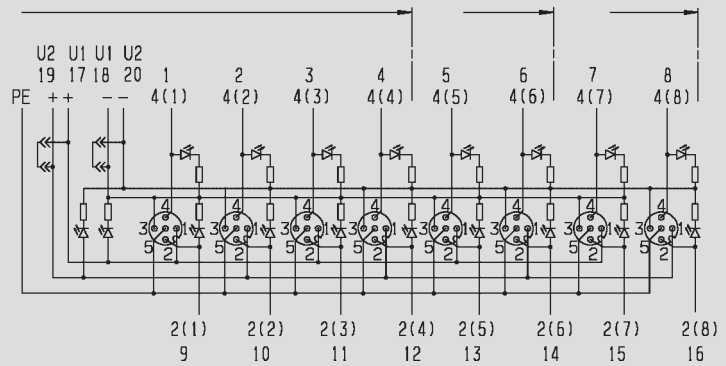
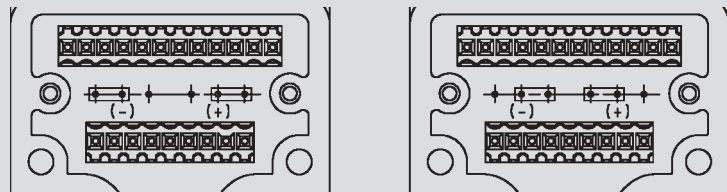
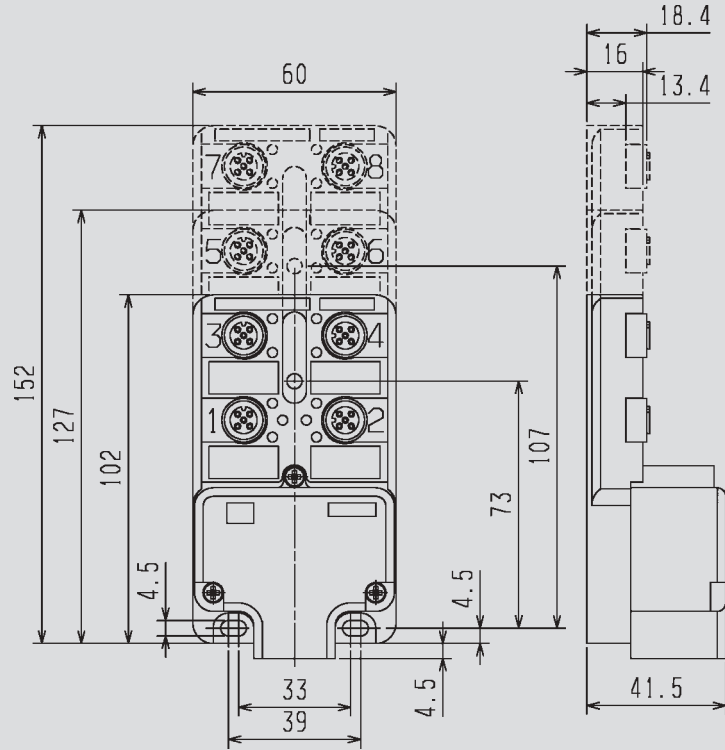

Order number register

Order No.	Page	Order No.	Page	Order No.	Page
C112 10A013...10	10	C112 13B004 000 24	16	C112 30B013...10	28
C112 10A024...10	10	C112 13B005 000 24	16	C112 30B024...10	28
C112 10A035...10	10	C112 13C004 000 24	16	C112 30B035...10	28
C112 10A043...10	10	C112 13C005 000 24	16	C112 30B048...10	28
C112 10A054...10	10	C112 13D004 000 24	16	C112 30B013... 30	28
C112 10A065...10	10	C112 13D005 000 24	16	C112 30B024... 30	28
C112 10B013...10	10	C112 13D004 000 01	17	C112 30B035... 30	28
C112 10B024...10	10	C112 13D004 000 02	17	C112 30B048... 30	28
C112 10B035...10	10	C112 13D004 000 03	17	C112 30C013...10	27
C112 10B043...10	10	C112 13D004 000 04	17	C112 30C024...10	27
C112 10B054...10	10	C112 13D004 000 05	17	C112 30C035...10	27
C112 10B065...10	10	C112 13D004 000 06	17	C112 30C048...10	27
C112 10C013...10	11	C112 13D004 000 07	17	C112 30C 013... 30	27
C112 10C024...10	11	C112 13D004 000 08	17	C112 30C 024... 30	27
C112 10C035...10	11	C112 14A004 000 24	17	C112 30C 035... 30	27
C112 10C043...10	11	C112 14A005 000 24	17	C112 30C 048... 30	27
C112 10C054...10	11	C112 14C004 000 24	17	C112 30D013...10	28
C112 10C065...10	11	C112 14C005 000 24	17	C112 30D024...10	28
C112 10D013...10	11	C112 20C013...10	22	C112 30D035...10	28
C112 10D024...10	11	C112 20C024...10	22	C112 30D048...10	28
C112 10D035...10	11	C112 20C035...10	22	C112 30D013... 30	28
C112 10D043...10	11	C112 20C043...10	22	C112 30D024... 30	28
C112 10D054...10	11	C112 20C054...10	22	C112 30D035... 30	28
C112 10D065...10	11	C112 20C065...10	22	C112 30D048... 30	28
C112 11A073...10	12	C112 20D013...10	22	C112 30X004 000 XX	29
C112 11A084...10	12	C112 20D024...10	22	C112 30X005 000 XX	29
C112 11A095...10	12	C112 20D035...10	22	C112 31A003 000 10	29
C112 11A103...10	12	C112 20D043...10	22	C112 31A004 000 10	29
C112 11A114...10	12	C112 20D054...10	22	C112 40A004 000 10	33
C112 11A125...10	12	C112 20D065...10	22	C112 40A005 000 10	33
C112 11B073...10	12	C112 21C073...10	23	C112 40B004 000 10	33
C112 11B084...10	12	C112 21C084...10	23	C112 40B005 000 10	33
C112 11B095...10	12	C112 21C095...10	23	C112 40E004 000 10	33
C112 11B103...10	12	C112 21C103...10	23	C112 40E005 000 10	33
C112 11B114...10	12	C112 21C114...10	23	C112 40F004 000 10	33
C112 11B125...10	12	C112 21C125...10	23	C112 40F005 000 10	33
C112 11C073...10	13	C112 21D073...10	23	C112 41A004 000 10	33
C112 11C084...10	13	C112 21D084...10	23	C112 41A005 000 10	33
C112 11C095...10	13	C112 21D095...10	23	C112 41B004 000 10	33
C112 11C103...10	13	C112 21D103...10	23	C112 41B005 000 10	33
C112 11C114...10	13	C112 21D114...10	23	C112 41E004 000 10	33
C112 11C125...10	13	C112 21D125...10	23	C112 41E005 000 10	33
C112 11D073...10	13	C112 30A013...10	27	C112 41F004 000 10	33
C112 11D084...10	13	C112 30A024...10	27	C112 41F005 000 10	33
C112 11D095...10	13	C112 30A035...10	27	C112 50U004 000 10	34
C112 11D103...10	13	C112 30A048...10	27	C112 50U006 000 10	34
C112 11D114...10	13	C112 30A 013... 30	27	C112 50U008 000 10	34
C112 11D125...10	13	C112 30A 024... 30	27		
C112 13A004 000 24	16	C112 30A 035... 30	27		
C112 13A005 000 24	16	C112 30A 048... 30	27		