

This document is the property of Amphenol Corporation and is prepared on the basis of information furnished to it. It is not to be reproduced, stored in a retrieval system, or transmitted in any form or by any means, electronic, mechanical, photocopying, recording, or by any information storage and retrieval system, without the prior consent, in writing, of Amphenol Corporation. It is to be used only for the purpose for which it was prepared. It is to be destroyed when it is no longer needed for the purpose for which it was prepared.

# Customer Drawing

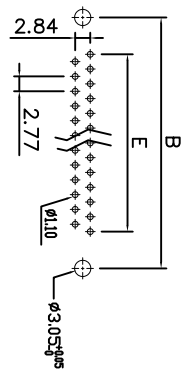

RECOMMENDED P.C.B. LAYOUT  
TOLERANCE: ±0.05MM

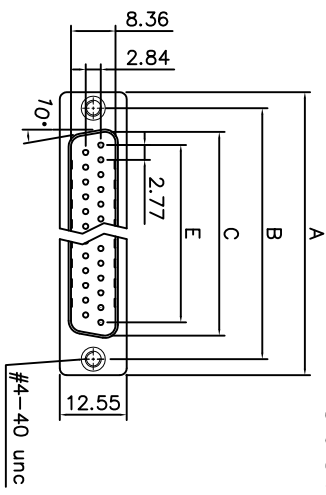
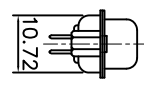
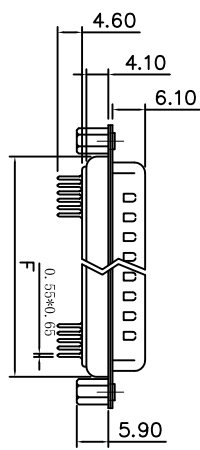

DIMENSION TABLE

SHELL SIZE	POSITIONS	A	B	C	E	F
E	09	30.81	24.99	16.92	11.08	19.20
A	15	39.14	33.32	25.25	19.39	27.70
B	25	53.04	47.04	38.96	33.24	41.10
C	37	69.32	63.50	55.42	49.86	57.30

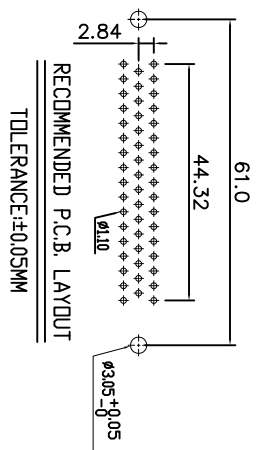
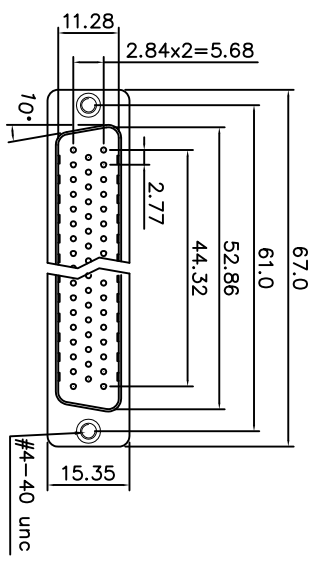

RECOMMENDED P.C.B. LAYOUT  
TOLERANCE: ±0.05MM

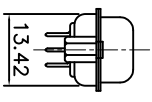
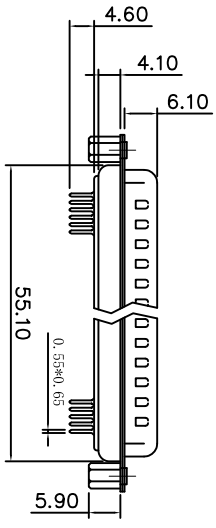

REVISIONS

SYM	ECN	DESCRIPTION	DATE	APPROVED
1	HK--	First Release Drawing	Aug/02/11	IP
2	HK--	Add dimension 5.9"	10/20/16	IP
3	HK--	Add dimension 4.50	05/24/19	IP
4	HK--	Add terminal dimension	05/06/23	Tony.Tong

## D-SUB TECHNICAL DATA

**SHELL :** Steel, 100u" min tin plated over 50u" min nickel over 50u" min Copper  
**BODY :** PBT UL 94V-0 Color: Black  
**CONTACTS :** Copper Alloy  
 Gold flash over 50u" min nickel on mating area.  
 100u" min tin over 50u" min nickel on solder area.  
**CLINCH NUT:** Copper alloy, 30u" min Nickel plated.  
**ELECTRICAL :** Voltage rating 250 V Rms  
 Current rating 3A.  
 Withstanding Voltage >1000 V Rms  
 Insulation resistance >1000 M Ohms  
 Contact resistance 20 mOhms max.

**MARKING :** Amphenol-...(Series No.)  
 Commercial reference  
 Manufacturing date

## PRODUCT CODE

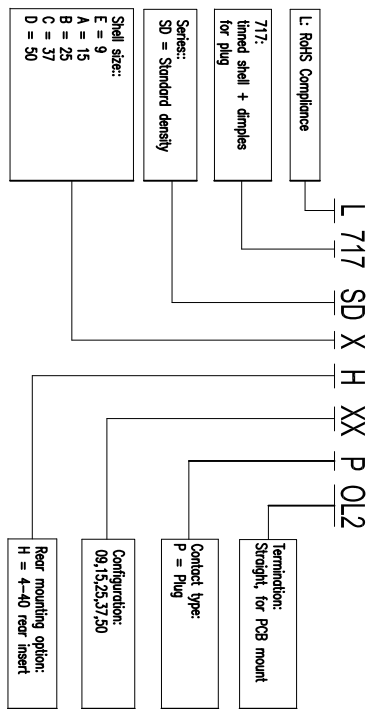

THICKNESS OTHERWISE SPECIFIED

TOLERANCES	UNITS	APPROVAL	DATE
±0.30	METRIC	DRWEN	Baha No. 06/06/23
±0.20	INCHES	CHECKED	Frang-Tong 06/06/23

FOR MATERIALS AND FINISHES SEE NOTES

DIMENSIONS	TOLERANCES	ANGLE OF PROJECTION
TS	INCHES	AS SHOWN
MW	MM	AS SHOWN

REMOVE SHARP EDGES

TITLE: D-SUB connector, SD Series

SIZE: DRAWING NO. L717SDXHXXP012

SCALE: NONE

SHEET: 1 OF 1

REV: 4

