

This document is the property of Amphenol Corporation and is delivered on the express condition that it is not to be disclosed, reproduced or used, in whole or in part, for manufacture or sale by anyone other than Amphenol Corporation without its prior consent, and that no right is granted to disclose or to use any information in this document.

The marking on this product doesn't contain environmental hazardous materials per Material Specification SS-00259 for Sony GP compliant or per directive 2011/65/EU for RoHS compliant.



ORIGINAL



REVISIONS				
SYM	ECN No.	DESCRIPTION	DATE	APPROVED
A	NE-16268	RELEASE TO PRODUCTION	11/30/2016	Arron Lin
B	NE-20096	MODIFY DIM.B TOLERANCE & ADD HOLDER RIB DIM.	07/17/2020	Roger Tsai

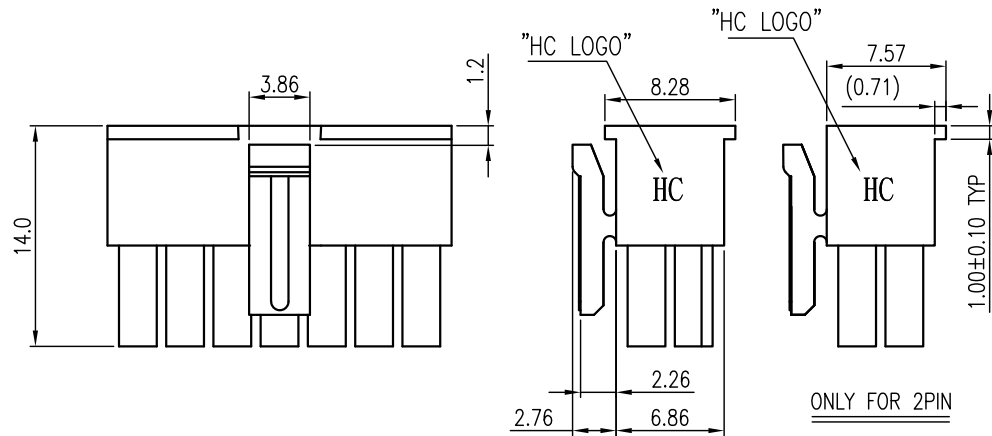
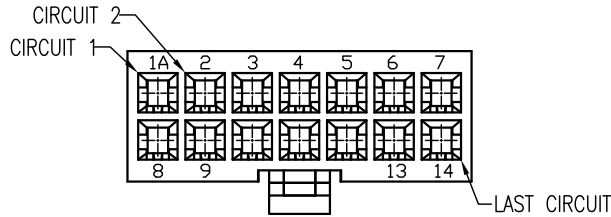

NOTES:

1. MATERIAL:
HOUSING: THERMOPLASTIC,NYLON66, UL94V-0, COLOR: BLACK.
2. PRODUCT SPECIFICATION REFER TO : PS-7528.
3. THIS PRODUCT DOESN'T CONTAIN ENVIRONMENTAL HAZARDOUS PER DIRECTIVE 2011/65/EU FOR RoHS COMPLIANT.
4. RECOMMENDED CRIMPING CONTACT P/N: G88MPC0232CEU/ G88MPC0332CEU/ G88MPC SERIES
5. TO ENSURE CURRENT RATING CAPABILITY, PLEASE ADOPT TOTAL SOLUTION.
(G88MPXX0... R/A BOARD-MOUNT SERIES WITH G88MPXX1... V/T BOARD-MOUNT SERIES)

POS	A	B
02	3.0	3.85
04	3.0	6.85
06	6.0	9.85
08	9.0	12.85
10	12.0	15.85
12	15.0	18.85
14	18.0	21.85
16	21.0	24.85
18	24.0	27.85
20	27.0	30.85
22	30.0	33.85
24	33.0	36.85

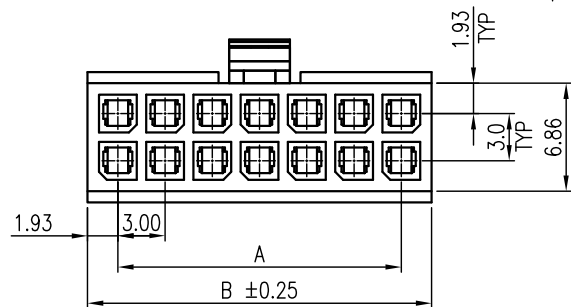
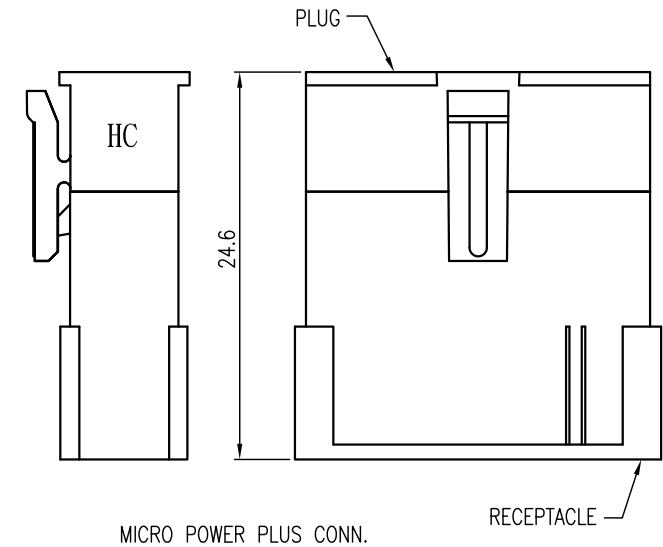

P/N: G88MPH XX 22CEU
POS.

TOLERANCE	APPROVALS	DATE	TITLE		Amphenol®		
X. ±0.30	DRAWN Jada Liu	07/17/2020	MICRO POWER PLUS CONN. 3.0MM PITCH, DUAL ROWS HOUSING ,CRIMPING TYPE		Amphenol Corporation Amphenol Taiwan Corporation		
X.X ±0.20	CHECKED Debby Hung	07/17/2020					
X.XXX ±0.10	APPROVED Roger Tsai	07/17/2020					
ANGULAR ±1°	DWG TYPE CUST DWG	PROJECT CODE SKT	UNIT mm	SIZE A3	PART No. G88MPHXX22CEU		
UNLESS OTHERWISE SPECIFIED			SCALE NA	SHEET 1 OF 3	DWG No. G88MPHXX22CEU		REV. B

This document is the property of Amphenol Corporation and is delivered on the express condition that is not to be disclosed, reproduced or used, in whole or in part, for manufacture or sale by anyone other than Amphenol Corporation without its prior consent, and that no right is granted to disclose or to use any information in this document.

The marking on this product doesn't contain environmental hazardous materials per Material Specification SS-00259 for Sony GP compliant or per directive 2011/65/EU for RoHS compliant.



ORIGINAL



REVISIONS				
SYM	ECN No.	DESCRIPTION	DATE	APPROVED
A	NE-16268	RELEASE TO PRODUCTION	11/30/2016	Arron Lin
B	NE-20096	MODIFY DIM.B TOLERANCE & ADD HOLDER RIB DIM.	07/17/2020	Roger Tsai

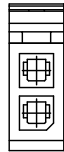

2*1P

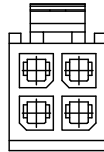

2*2P

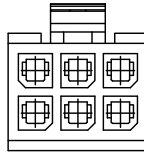

2*3P

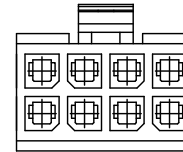

2*4P

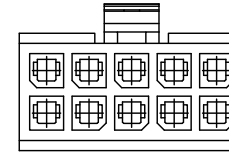

2*5P

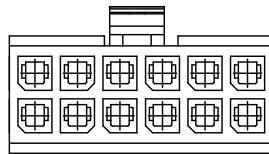

2*6P

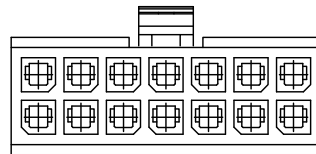

2*7P

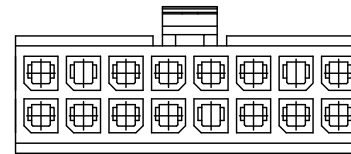

2*8P

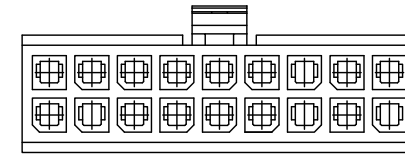

2*9P

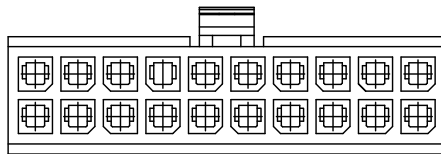

2*10P

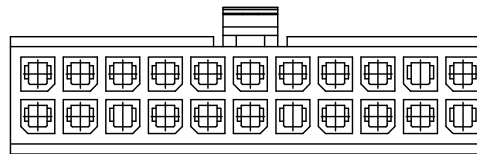

2*11P

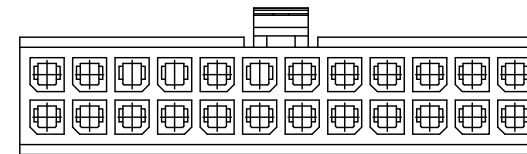

2*12P

TOLERANCE		APPROVALS		DATE	TITLE			Amphenol®						
X.		DRAWN	Juda Liu	07/17/2020	MICRO POWER PLUS CONN. 3.0MM PITCH, DUAL ROWS HOUSING ,CRIMPING TYPE			Amphenol Corporation Amphenol Taiwan Corporation						
X.X	±0.30	CHECKED	Debby Hung	07/17/2020										
X.XX	±0.20	APPROVED	Roger Tsai	07/17/2020										
X.XXX	±0.10	UNLESS OTHERWISE SPECIFIED		CUST DWG	PROJECT CODE	SKT			UNIT	mm	SIZE	A3	PART No.	G88MPHXX22CEU
ANGULAR	±1°				DWG TYPE		SCALE	NA	SHEET	2 OF 3	DWG No.	G88MPHXX22CEU	REV.	B

This document is the property of Amphenol Corporation and is delivered on the express condition that is not to be disclosed, reproduced or used, in whole or in part, for manufacture or sale by anyone other than Amphenol Corporation without its prior consent, and that no right is granted to disclose or to use any information in this document.

The marking on this product doesn't contain environmental hazardous materials per Material Specification 5S-00259 for Sony GP compliant or per directive 2011/65/EU for RoHS compliant.



ORIGINAL



REVISIONS				
SYM	ECN No.	DESCRIPTION	DATE	APPROVED
A	NE-16268	RELEASE TO PRODUCTION	11/30/2016	Arron Lin
B	NE-20096	MODIFY DIM.B TOLERANCE & ADD HOLDER RIB DIM.	07/17/2020	Roger Tsai

PRODUCT

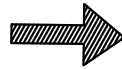
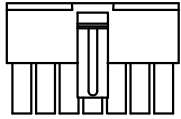

PE BAGE

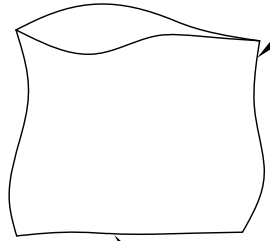

1000 PCS

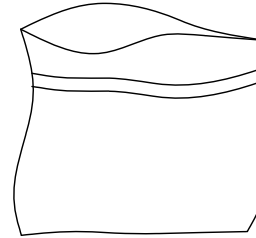

AIR BAGE

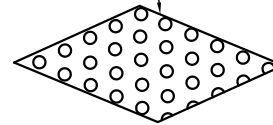

CARTON

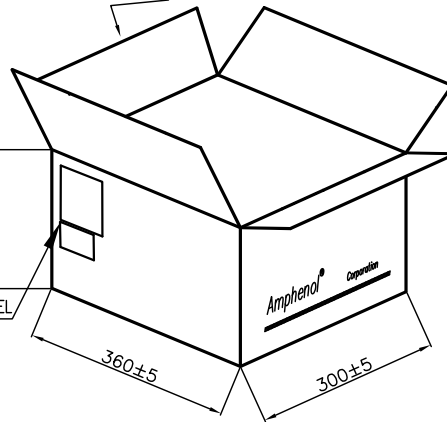

LABEL

TAPE

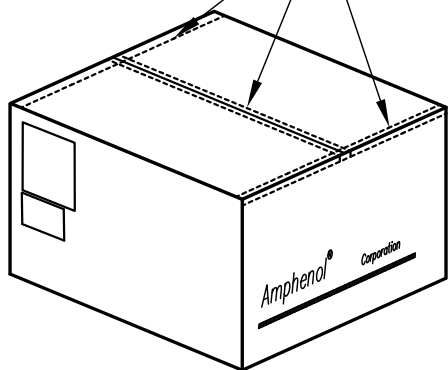

POS	PCS/PE BAGE	PCS/CARTON
02	1000	12000
04	1000	10000
06	1000	10000
08	800	8000
10	800	8000
12	800	8000
14	800	8000
16	600	6000
18	600	6000
20	600	6000
22	500	5000
24	500	5000

TOLERANCE		APPROVALS		DATE	TITLE		Amphenol®		
X.		DRAWN	Juda Liu	07/17/2020	MICRO POWER PLUS CONN. 3.0MM PITCH, DUAL ROWS HOUSING ,CRIMPING TYPE		Amphenol Corporation Amphenol Taiwan Corporation		
X.X	±0.30	CHECKED	Debby Hung	07/17/2020					
X.XX	±0.20	APPROVED	Roger Tsai	07/17/2020					
X.XXX	±0.10	DWG TYPE		PROJECT CODE			UNIT	SIZE	PART No.
ANGULAR	±1°	CUST DWG		SKT			mm	A3	G88MPHXX22CEU
UNLESS OTHERWISE SPECIFIED					SCALE	SHEET	DWG No.		REV.
					NA	3 OF 3	G88MPHXX22CEU		B