

THIS DRAWING IS SUPPLIED FOR INFORMATION ONLY. DESIGN FEATURES, SPECIFICATIONS AND PERFORMANCE DATA SHOWN HEREON ARE THE PROPERTY OF THE AMPHENOL CORPORATION. NO RIGHTS OF REPRODUCTION ARE IMPLIED. ALL DIMENSIONS ARE SUBJECT TO NORMAL MANUFACTURING VARIATIONS.

# CUSTOMER DRAWING

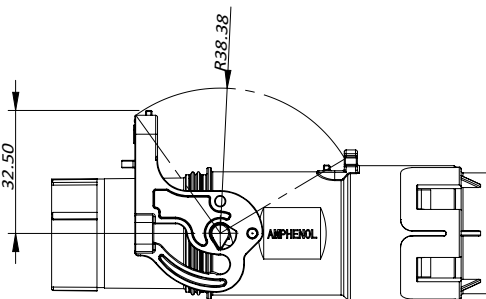
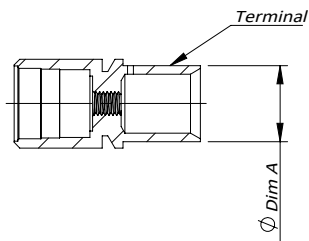
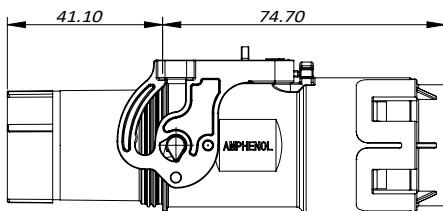
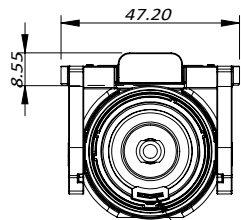
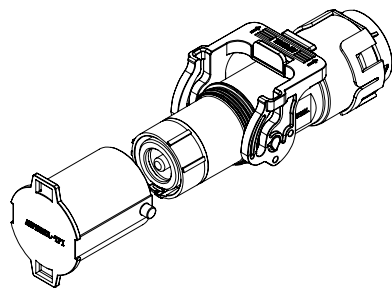

## Standard Part List:

Model No.	H+S Part No.	Dia. Primary Insulation(mm)	Dia. of Screen max.(mm)	Overall-Dia. Nominal(mm)	Outside-Dia. of terminal(mm): "A"	Inside-Dia. of terminal(mm): "B"
PL18(X)-50X-70-2-5	84100298	13.7±0.3	14.6	17.0±0.3	16.7±0.3	12.2±0.3
PL18(X)-50X-95-2-5	84100299	16.2±0.3	17.3	19.9±0.4	17.9±0.3	13.9±0.3
PL18(X)-50X-120-2-5	84103410	18.0±0.3	19.1	22.6±0.4	20.1±0.3	15.6±0.3

Key Characteristics  Critical 关键特性  
 Amphenol for Latest Definition  Significant 重要性

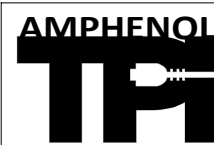

## Amphenol Technical Products International Asia.

第三角投影 THIRD ANGLE PROJECTION	页面 SHEET	幅面 SIZE	版次 REV.	比例 SCALE	PART NAME: <b>PwrLok 14mm G2 straight plug</b>
	1 OF 2	A4	F		
DWG NO: <b>PL18X-50X-XX-2-5</b>					CUST PART #
CUST REV.					

签名 SIGNATURE: July.su  
 日期 DATE: 03/01/2023  
 制图 DRAWN: July.su  
 审核 CHECKED:  
 批准 APPROVAL:

UNLESS OTHERWISE SPECIFIED  
 1) All dimensions are in metric(mm).  
 2) Tolerances are as follows:  
 1.PL DEC ± 1.00  
 2.PL DEC ± 0.50  
 3.PL DEC ± 0.20  
 Angles ±1°

## 订购信息 Ordering Information

PL18 X - 50 1 - 95 - 2 - 5

<b>Key and Color</b> "X", Orange "Y", Black "U", Yellow "V", Green "W", Red "T", Blue	<b>HVIL</b> "0", NO HVIL "1", With HVIL	<b>Cable size:</b> "70"=70mm² "95"=95mm² "120"=120mm²	<b>Cable Type:</b> "-5", Huber+Suhner
---	---	--	--

### 规格参数(Spec.):

- 工作温度 Operating temperature: -40°C ~ +125°C.  E
- 带高压互锁 Electrical interlock (HVIL).
- 额定电流 Current rating:  
Power: 70mm², 250A; 95mm², 300A; 120mm², 400A; HVIL: 5A.
- 额定电压 Operating voltage:  
Power: 1500 VDC; Signal: 60 VDC.  E
- 耐压 Dielectric withstanding voltage:  
A. 与插座对插后, Pin与铁壳之间  
When mated, between pin and metal shell: 8000 VDC.  F  
B. 与插座对插后, Pin与HVIL之间  
When mated, between pin and HVIL: 8000 VDC.  F  
C. 与插座对插后, HVIL与铁壳之间  
When mated, between HVIL and metal shell: 500 VDC.  
D. 与插座对插前, 两个HVIL端子之间耐压  
Before mating, between two HVIL terminals: 500 VDC.
- 防护等级 Protection class: Mated-IP6k9k & IP67, unmated-IP2X.
- 电磁屏蔽 360° full Shielding.
- 机械寿命 Mating cycle: 100 Min.
- 带CPA的摇杆系统 Latch system with CPA.
- 绝缘材料满足UL94 V-0 Inner insulation material satisfy UL94V-0.
- 镀锌/锌镍合金, 符合RoHS, 满足500H中性盐雾实验  
Gray Zinc/Nickel(ZnNi)Plating. RoHS compliant, Rated at 500hours salt spray.
- 对配插座型号: Model of mating receptacle: PL00(X)-50(X)-10(XX)-2.
- 产品满足RoHS和Reach要求. RoHS and Reach compliant.  V
- 绝缘体为140°RTI材料. The insulators are 140° RTI material.  E

REVISIONS					
REV#	ECN#	REVISION ACTION	REV.BY:	APPR.BY:	DATE
A	--	INITIAL RELEASE	Jack	James	03/31/2020
B	--	增加表格信息	Star	James	10/29/2020
C	--	Add Dust Cap And Protection Cap	Star	James	12/30/2020
D	--	Change the temperature of technical points	Star	James	12/03/2021
E	--	Change operating temperature, voltage	JS	JL	08/11/2022
F	--	Change dielectric withstanding voltage	JS	JL	03/01/2023

THIS DRAWING IS SUPPLIED FOR INFORMATION ONLY. DESIGN FEATURES, SPECIFICATIONS AND PERFORMANCE DATA SHOWN HEREON ARE THE PROPERTY OF THE AMPHENOL CORPORATION. NO RIGHTS OF REPRODUCTION ARE IMPLIED. ALL DIMENSIONS ARE SUBJECT TO NORMAL MANUFACTURING VARIATIONS.

1	2	3	4	5	6	7	8
型号 Model	Kit Package P/N	Bulk Package P/N					
PL18X-501-95-2-5	AC-HA011921	AC-HA011921-2					
PL18Y-501-95-2-5	AC-HA011922	AC-HA011922-2					
PL18U-501-95-2-5	AC-HA011923	AC-HA011923-2					
PL18V-501-95-2-5	AC-HA011924	AC-HA011924-2					
PL18W-501-95-2-5	AC-HA011925	AC-HA011925-2					
PL18T-501-95-2-5	AC-HA011926	AC-HA011926-2					
PL18X-500-95-2-5	AC-HA011927	AC-HA011927-2					
PL18Y-500-95-2-5	AC-HA011928	AC-HA011928-2					
PL18U-500-95-2-5	AC-HA011929	AC-HA011929-2					
PL18V-500-95-2-5	AC-HA011930	AC-HA011930-2					
PL18W-500-95-2-5	AC-HA011931	AC-HA011931-2					
PL18T-500-95-2-5	AC-HA011932	AC-HA011932-2					
PL18X-501-120-2-5	AC-HA011933	AC-HA011933-2					
PL18Y-501-120-2-5	AC-HA011934	AC-HA011934-2					
PL18U-501-120-2-5	AC-HA011935	AC-HA011935-2					
PL18V-501-120-2-5	AC-HA011936	AC-HA011936-2					
PL18W-501-120-2-5	AC-HA011937	AC-HA011937-2					
PL18T-501-120-2-5	AC-HA011938	AC-HA011938-2					
PL18X-500-120-2-5	AC-HA011939	AC-HA011939-2					
PL18Y-500-120-2-5	AC-HA011940	AC-HA011940-2					
PL18U-500-120-2-5	AC-HA011941	AC-HA011941-2					
PL18V-500-120-2-5	AC-HA011942	AC-HA011942-2					
PL18W-500-120-2-5	AC-HA011943	AC-HA011943-2					
PL18T-500-120-2-5	AC-HA011944	AC-HA011944-2					
PL18X-500-70-2-5	AC-HA012918	AC-HA012918-2					
PL18Y-500-70-2-5	AC-HA012919	AC-HA012919-2					
PL18U-500-70-2-5	AC-HA012920	AC-HA012920-2					
PL18V-500-70-2-5	AC-HA012921	AC-HA012921-2					
PL18W-500-70-2-5	AC-HA012922	AC-HA012922-2					
PL18T-500-70-2-5	AC-HA012923	AC-HA012923-2					
PL18X-501-70-2-5	AC-HA012924	AC-HA012924-2					
PL18Y-501-70-2-5	AC-HA012925	AC-HA012925-2					
PL18U-501-70-2-5	AC-HA012926	AC-HA012926-2					
PL18V-501-70-2-5	AC-HA012927	AC-HA012927-2					
PL18W-501-70-2-5	AC-HA012928	AC-HA012928-2					
PL18T-501-70-2-5	AC-HA012929	AC-HA012929-2					

REVISIONS					
REV#	ECN#	REVISION ACTION	REV.BY:	APPR.BY:	DATE
A	--	INITIAL RELEASE	Jack	James	03/31/2020
B	--	增加表格信息	Star	James	10/29/2020
C	--	Add Dust Cap And Protection Cap	Star	James	12/30/2020
D	--	Change the temperature of technical points	Star	James	12/03/2021
E	--	Change operating temperature, voltage	JS	JL	08/11/2022
F	--	Change dielectric withstanding voltage	JS	JL	03/01/2023

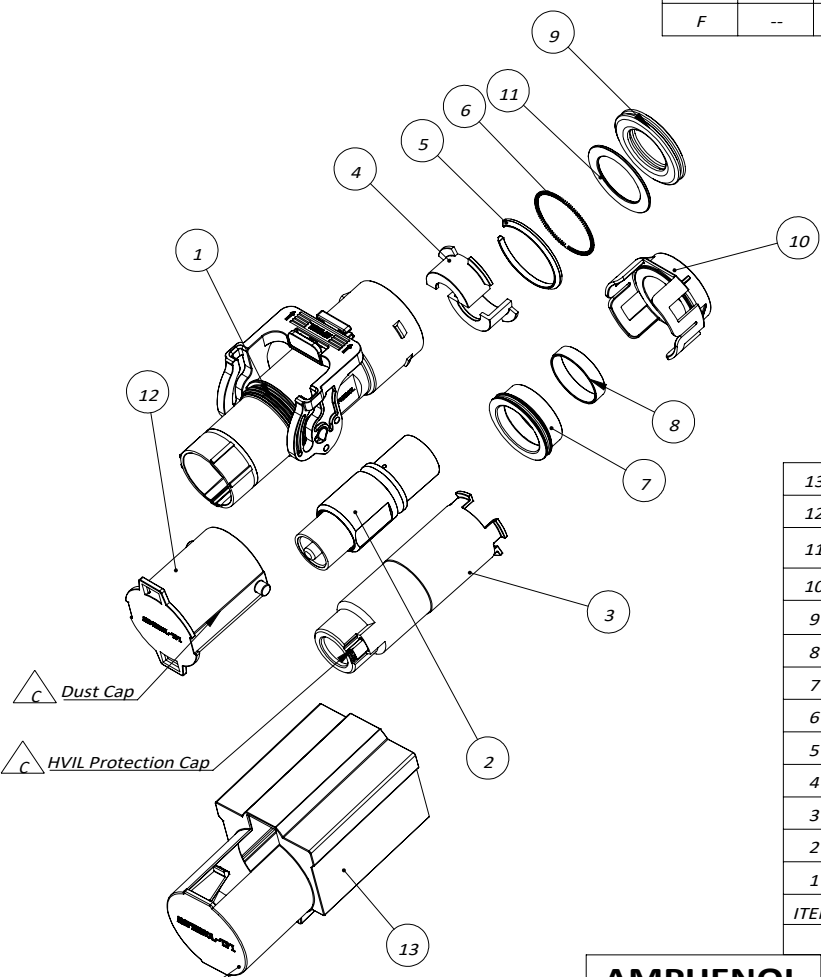

13	PL500 G2 1 POS plug protection cap	1	Order P/N AC-CP001600
12	PL500 G2 Dust Cap for Plug	1	
11	PL500 G2 Metal Gasket	1	Different P/N are used according to different Cable sizes
10	PL500 G2 Tail Cap for straight plug	1	Different P/N are used according to different Cable sizes
9	PL500 G2 cable sealing for straight plug	1	Different P/N are used according to different Cable sizes
8	PL500 G2 Inner Copper Ring	1	
7	PL500 G2 Outer Copper Ring for Straight Plug	1	
6	PL500 G2 Coil Spring for straight Plug	1	
5	PL500 G2 Lock Housing2	1	
4	PL500 G2 Lock Housing1	2	Different P/N are used according to different Cable sizes
3	PL500 G2 Insulation Sleeve Assy	1	
2	PL500 G2 Terminal Assy	1	Different P/N are used according to different Cable sizes
1	PL500 G2 Shell Plug Assy	1	Different P/N are used according to different Cable sizes
ITEM	DESCRIPTION	QTY	REMARK

MATERIALS LIST

Note: Optional to be ordered separately

**Amphenol Technical Products International Asia.**

第三角投影 THIRD ANGLE PROJECTION	页面 SHEET	幅面 SIZE	版次 REV.	比例 SCALE	PART NAME: <b>PwrLok 14mm G2 straight plug</b>
	2 OF 2	A4	F		

签名 SIGNATURE	日期 DATE	UNLESS OTHERWISE SPECIFIED 1) All dimensions are in metric (mm). 2) Tolerances are as follows: 1.PL DEC ± 1.00 2.PL DEC ± 0.50 3.PL DEC ± 0.20 Angles ±1°	DWG NO: <b>PL18X-50X-XX-2-5</b>	
制图 DRAWN	July.su		CUST PART #	CUST REV.
审核 CHECKED				
批准 APPROVAL				